

PRO-MED



Thorax

Cardiovascular

PRO-MED

Dieser Katalog bleibt unser ausschließliches Eigentum.

Die "Allgemeinen Lieferungs- und Zahlungsbedingungen" sind in unserer jeweils gültigen Preisliste abgedruckt.

Nachdruck, auch auszugsweise, ist verboten.

This catalogue remains our exclusive property.

Our "General Terms of Sale and Payment" may be found in our latest valid price list.

Reprinting, even partially, is prohibited.

Ce catalogue est exclusivement notre propriété.

Nos "Conditions générales de vente et de paiement" sont imprimées dans notre liste de prix courante.

Toute représentation ou reproduction intégrale ou partielle fait sans l'autorisation EXPRESSE DE LA SOCIETE PRO-MED est interdite.

Este catálogo es exclusivamente de nuestra propiedad.

Tambien queremos hacer hincapie en nuestras condiciones generales de venta y de pago.

Reproducción, aunque sea parcial, queda terminantemente prohibida.

Garantierte Qualitätsinstrumente
Guaranteed Quality Instruments
Instruments de Chirurgie de qualité garantié
Instrumentos de Calidad con garantia

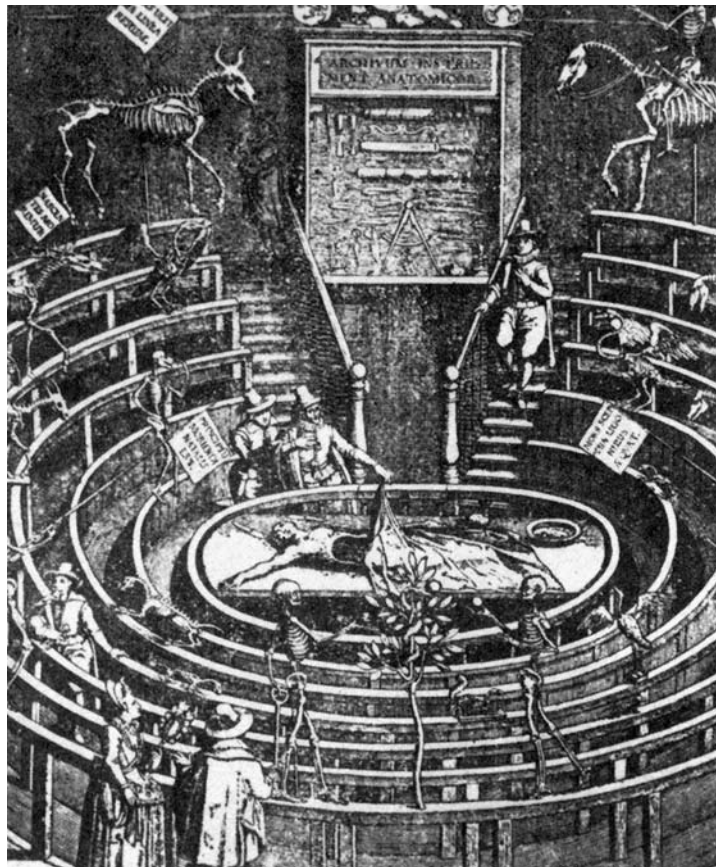

PRO-MED Instrumente GmbH
Gänsäcker 9
D-78532 TUTTLINGEN
Germany

Telephone +49(0) 74 62 / 20 42 40
Telefax +49(0) 74 62 / 20 42 49 0
E-Mail pro-med-tut@t-online.de
Internet www.pro-med-tut.de

PRO-MED

Qualität ist eine Frage des Anspruchs ...

Quality is a question of demand ...

La qualité est une question d'exigence ...

Calidad es la pregunta de pretension ...



1



2

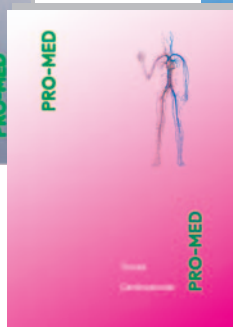

3



4

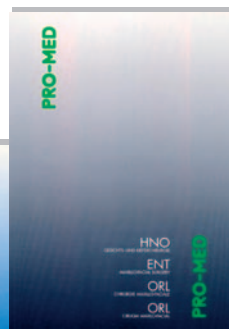

5

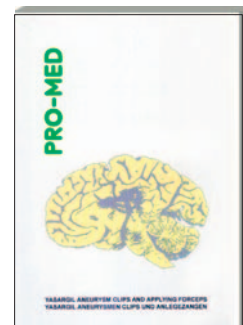

6

Catalogs

- 1 General Instruments
- 2 Bone Surgery / Neuro Surgery / Micro Surgery
- 3 Thorax / Cardiovascular
- 4 Stomach / Intestines / Rectum / Liver / Gall Kidneys / Urology / Gynecology / Obstetrics
- 5 ENT
- 6 Aneurysm Clips

12	SKALPELLKLINGEN, -GRIFFE SCALPEL BLADES, HANDLES LAMES, MANCHES HOJAS, MANGOS DE BISTURIES	1-7
13	SCHEREN SCISSORS CISEAUX TIJERAS	8-24
14	PINZETTEN DRESSING- AND TISSUE FORCEPS PINCES À DISSECTION PINZAS DE DISECCIÓN	25-33
14	ATRAUMATISCHE PINZETTEN NON-TRAUMATIC TISSUE FORCEPS PINCES À MORS NON-TRAUMATISANTS PINZAS CON BOCAS ATRAUMÁTICAS	34-35
14	PROMEDUR PINZETTEN PROMEDUR DISSECTING FORCEPS PROMEDUR PINCES À DISSECTION PROMEDUR PINZAS DE DISECCIÓN	36-37
14	BIPOLARE KOAGULATIONSPINZETTEN BIPOLAR COAGULATING FORCEPS PINCES À COAGULATION BIPOLAIRE PINZAS PARA COAGULACIÓN BIPOLAR	38-43
15	ARTERIENKLEMMEN HEMOSTATIC FORCEPS PINCES HÉMOSTATIQUES PINZAS HEMOSÁTICAS	45-58
48	GEWEBE- UND ORGANFASSZANGEN TISSUE- AND ORGANHOLDING FORCEPS PINCES À PREHENSION PINZAS PARA TEJIDOS Y ORGANOS	59-62
17	WUNDHAKEN RETRACTORS ECARTEURS SEPARADORES	63-80
18	NADELHALTER NEEDLEHOLDERS PORTE-AIGUILLES PORTA-AGUJAS	81-87
19	SAUGROHRE, VENENSTRIPPER SUCTION, VARICOSE ASPIRATION, VARICES ASPIRACIÓN, VARICES	89-92
23	DISSEKTOREN, ELEVATORIEN, RASPATORIEN DISSECTORS, ELEVATORS, RASPATORIES DISSECTEURS, ELEVATEURS, RUGINES DISECADORES, ELEVADORES, PERIOSTÓTOMOS	93-98

23	KNOCHENINSTRUMENTE BONE INSTRUMENTS INSTRUMENTS POUR OS INSTRUMENTOS PARA HUESOS	99-105
40	RIPPENSCHEREN RIB SHEARS COSTOTOMES COSTÓTOMOS	105-108
40	RIPPENSPERRER RIB SPREADERS ECARTEURS STERNAUX SEPARADORES COSTALES	109-121
40	BRONCHUS-, LIGATUR-, UND LUNGENFASSZANGEN BRONCHUS-, LIGATURE- AND LUNG GRASPING FORCEPS PINCES-DISSECTEURS À LIGATURE ET À POUMON PINZAS PARA BRONQUIOS, LIGADURAS Y PULMON	122-123
40	COOLEY GEFÄSSKLEMMEN COOLEY NON-TRAUMATIC VASCULAR CLAMPS COOLEY CLAMPS À MORS NON-TRAUMATISANTS COOLEY PINZAS-CLAMPS ATRAUMATICAS	124-136
40	NEONATAL- UND KINDERKLEMMEN NEONATAL AND PEDIATRIC CLAMPS PINCES-CLAMPS POUR NOUVEAUX-NÉS ET ENFANTS PINZAS-CLAMPS PARA RECIEN NACIDOS Y NIÑOS	136-139
41	ATRAUMATISCHE BULLDOGKLEMMEN NON-TRAUMATIC BULLDOG CLAMPS CLAMPS BULLDOG NON-TRAUMATISANTS CLAMPS BULLDOG ATRAUMATICAS	140-147
41	DEBAKEY ATRAUMATISCHE GEFÄSSKLEMMEN DEBAKEY NON-TRAUMATIC VASCULAR CLAMPS DEBAKEY CLAMPS VASCULAIRES À MORS NON-TRAUMATISANTS DEBAKEY PINZAS-CLAMPS ATRAUMATICAS	148-172
40	SPEZIELLE GEFÄSSINSTRUMENTE VESSEL INSTRUMENTS INSTRUMENTS POUR VAISSEAUX INSTRUMENTAL VASCULAR	173-178
28	INSTRUMENTE FÜR DIE MIKROVASCULARE CHIRURGIE INSTRUMENTS FOR MICROVASCULAR SURGERY INSTRUMENTS POUR CHIRURGIE MICROVASCULAIRE INTRUMENTAL PARA MICRO-CIRUGIA	179-185

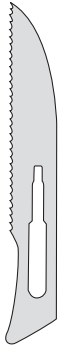

12.0009
Sägeblatt
saw blade
lame dentée
hoja de sierra

steril, in Packungen à 100
sterile, in packages of 100
stériles, en boîtes de 100
estériles, en cajas de 100



12.0010
10



12.0011
11



12.0012
12



12.0042
12 d



12.0013
13



12.0014
14



12.0015
15



12.0045
15 c



12.0016
16



12.0017
17

steril, in Packungen à 100
sterile, in packages of 100
stériles, en boîtes de 100
estériles, en cajas de 100

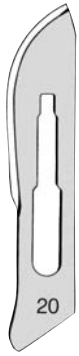

12.0020
20



12.0021
21



12.0022
22



12.0018
18



12.0019
19



12.0023
23



12.0024
24



12.0025
25



12.0034
34



12.0036
36



12.0044
24 d



12.0046
36 d

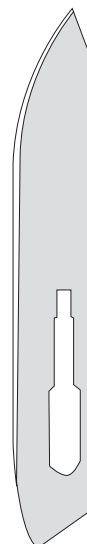

POST-MORTEM

12.0060
nicht steril
not sterile
pas stériles
no estériles



12.0070
KLING-EX Klingentferner
Scalpel-blade remover
Oteur-bistouris
Quita hojas



12.0101
Technical #3



12.0102
Technical #4



12.0103
#3



12.0104
#4



12.0105
3/4



12.0106
#7 K



12.0107
#7



COLLIN
12.0108
#8



COLLIN
12.0109
#9



12.0113
#3 L

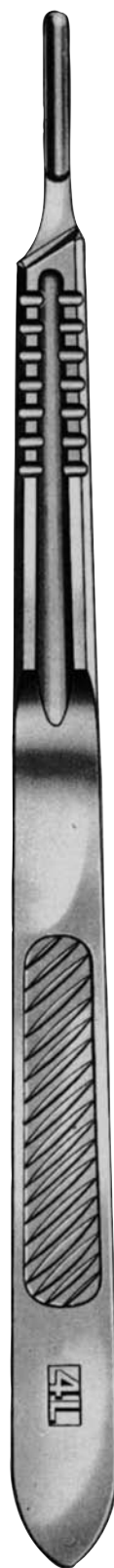

12.0114
#4 L

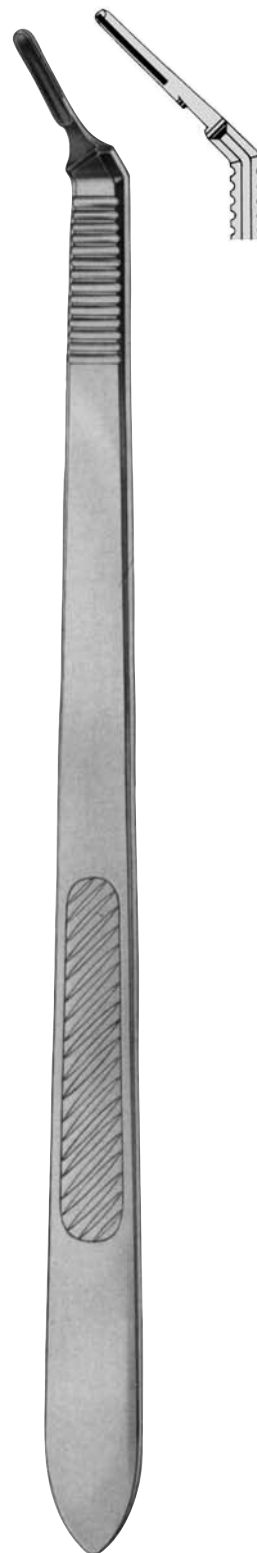

12.0115
#3 L



12.0125
#5, 16 cm



12.0127
#7 L



12.0133
#3, 21cm

Mikrochirurgische Klingen 0,6 mm und Griff
 Microsurgery blades 0,6 mm and handle
 Couteaux 0,6 mm et manche pour microchirurgie
 Cuchillos 0,6 mm y mangos para microcirugia

in Packungen à 10 St.
 in packages of 10 ea.
 en boîtes de 10 pièces
 en cajas de 10 c/u



12.0061
#61



12.0062
#62



12.0062S
#62S



12.0065
#65



12.0067
#67



ANATOMY
12.0144
#4



ANATOMY
12.0149
#9



BARRON
12.0163
#3

Griffe für Klingen
 handles for blades
 manches pour lames
 mangos para hojas
 12.0061 - 12.0067



12.0180 100 mm
12.0182 125 mm
12.0184 155 mm
12.0186 180 mm
12.0188 200 mm



TROUTMAN
12.5000 10 cm



TROUTMAN
12.5001 10 cm



CASTROVIEJO
12.5010 13 cm / 8 mm
12.5012 13 cm / 10 mm



BARRAQUER
12.5020 11 cm

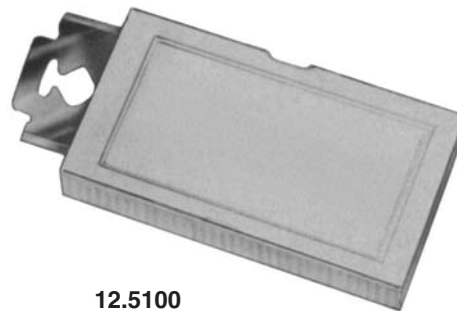

12.5100
Packung = 10
Package = 10
Boîte = 10
Cajita = 10



IRIS



**IRIS
 SUPERCUT (SC)**

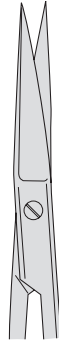

13.0010 9,0 cm
13.0010SC 9,0 cm
13.0012 10,5 cm
13.0012SC 10,5 cm
13.0014 11,5 cm
13.0014SC 11,5 cm
13.0014SCZ 11,5 cm
 gezahnt, serrated,
 dentées, dentadas

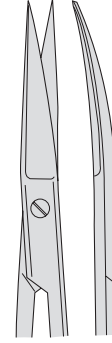

13.0011 9,0 cm
13.0011SC 9,0 cm
13.0013 10,5 cm
13.0013SC 10,5 cm
13.0015 11,5 cm
13.0015SC 11,5 cm
13.0015SCZ 11,5 cm
 gezahnt, serrated,
 dentées, dentadas



13.0022
 10 cm

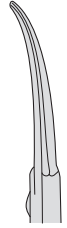

13.0023
 10 cm

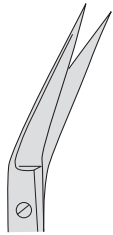

13.0043 10,5 cm
13.0043SC 10,5 cm
13.0045 11,0 cm

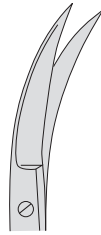

WALKER-IRIS
13.0051 9,0 cm
13.0053 10,5 cm
13.0055 11,5 cm



IRIS



13.0032
 10 cm
 mit grossen Ringen
 with large rings
 avec anneaux larges
 con anillos grandes



13.0033
 10 cm



IRIS
13.0056
 10,5 cm

Linkshändig, left handed,
 pour gaucher, para zurdo



IRIS
13.0057
 10,5 cm



STRABISMUS
11,5 cm



**STRABISMUS
SUPERCUT (SC)**
11,5 cm

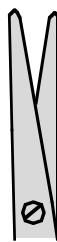

13.0060
13.0060SC



13.0061
13.0061SC



STRABISMUS
13.0062 11,5 cm



STRABISMUS
13.0063 11,5 cm



13.0070
11 cm



13.0071
11 cm



STEVENS



**STEVENS
SUPERCUT (SC)**



13.0076
10,5 cm
13.0080
11,5 cm
13.0080SC
11,5 cm

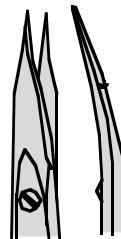

13.0077
10,5 cm
13.0081
11,5 cm
13.0081SC
11,5 cm



13.0078
10,5 cm
13.0082
11,5 cm
13.0082SC
11,5 cm



13.0079
10,5 cm
13.0083
11,5 cm
13.0083SC
11,5 cm



Präparierschere
Dissecting Scissors
Ciseaux à dissection
Tijera de disección

POTTS
13.0089
14 cm

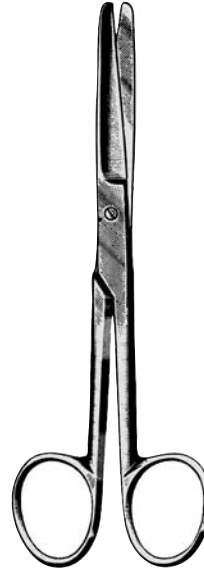

DEAVER
13.0102
14 cm



DEAVER
13.0103
14 cm

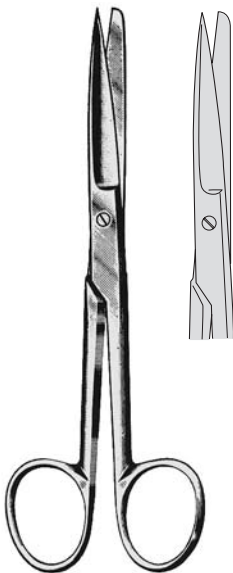

DEAVER
13.0112
14 cm

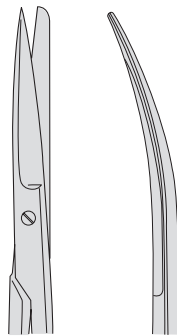

DEAVER
13.0113
14 cm

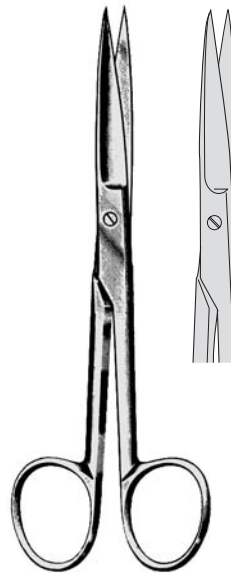

DEAVER
13.0122
14 cm

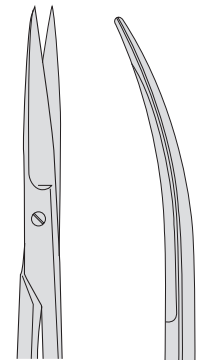

DEAVER
13.0123
14 cm

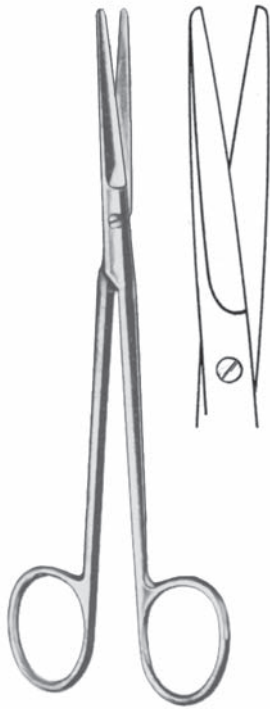

MIXTER
13.0130
15 cm



MIXTER
13.0131
15 cm

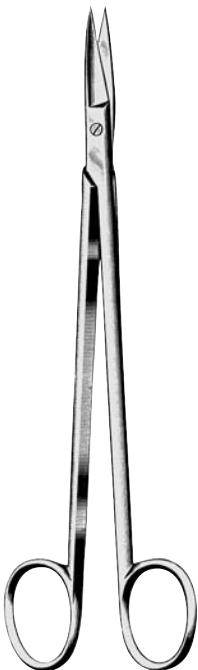

KELLY
13.0140
glatt / smooth
lisse / lisa
13.0146
gezahnt / serrated
dentées / dentadas

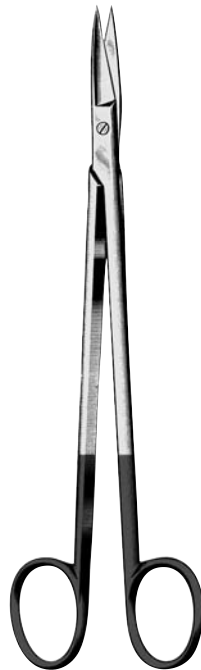

KELLY
SUPERCUT (SC)
13.0140SC
gerade / straight
droits / recta



KELLY
13.0141 16 cm
13.0141SC 16 cm
glatt / smooth
lisse / lisa
13.0147
gezahnt / serrated
dentées / dentadas



KELLY
13.0143SC 16 cm



MAYO



**MAYO
 SUPERCUT (SC)**



- 13.0400** 14,5 cm
- 13.0400SC** 14,5 cm
- 13.0404** 17,0 cm
- 13.0404SC** 17,0 cm
- 13.0406** 20,0 cm
- 13.0406SC** 20,0 cm
- 13.0408** 23,0 cm
- 13.0408SC** 23,0 cm

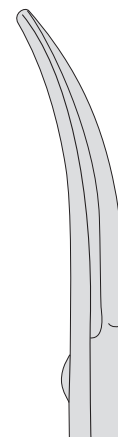

- 13.0401** 14,5 cm
- 13.0401SC** 14,5 cm
- 13.0405** 17,0 cm
- 13.0405SC** 17,0 cm
- 13.0407** 20,0 cm
- 13.0407SC** 20,0 cm
- 13.0409** 23,0 cm
- 13.0409SC** 23,0 cm

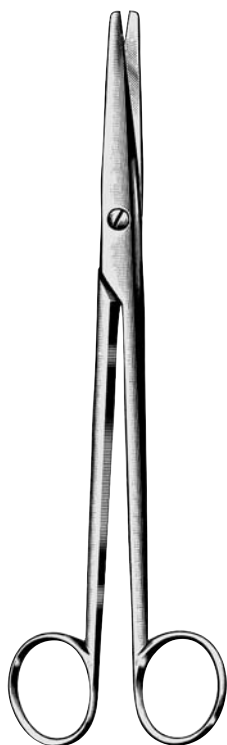

MAYO-STILLE

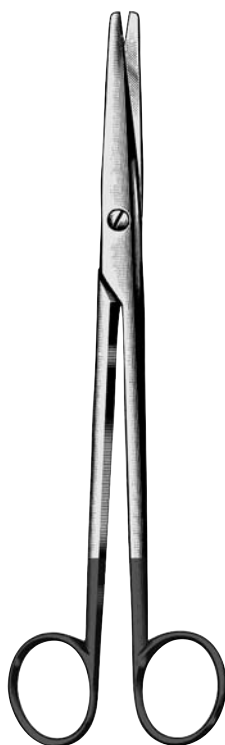

**MAYO-STILLE
 SUPERCUT (SC)**



- 13.0432** 15,0 cm
- 13.0434** 17,0 cm
- 13.0434SC** 17,0 cm
- 13.0436** 19,5 cm
- 13.0438** 21,0 cm
- 13.0433** 15,0 cm
- 13.0435** 17,0 cm
- 13.0435SC** 17,0 cm
- 13.0437** 19,5 cm
- 13.0439** 21,0 cm

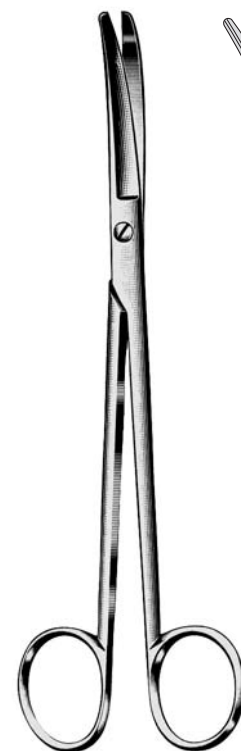

WERTHEIM

- 13.0561** 14,5 cm
- 13.0562** 19,5 cm
- 13.0563** 22,5 cm

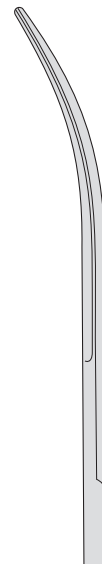



THOREK
 13.0565 19 cm
 13.0567 23 cm

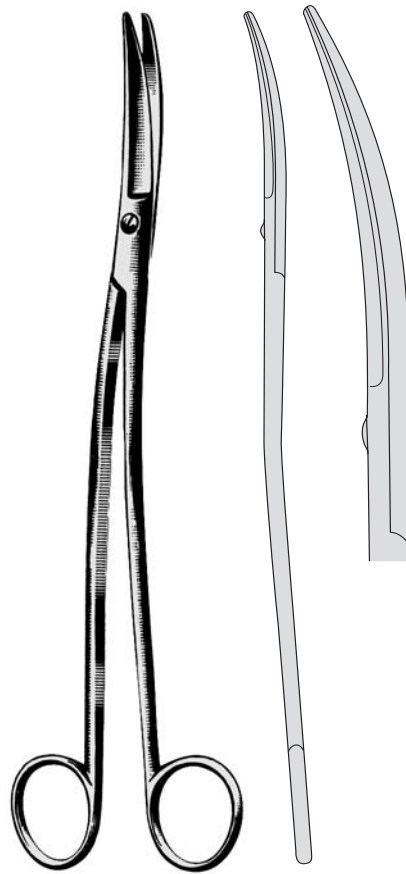

KLINGENBERG-LOTH
 13.0575 23 cm

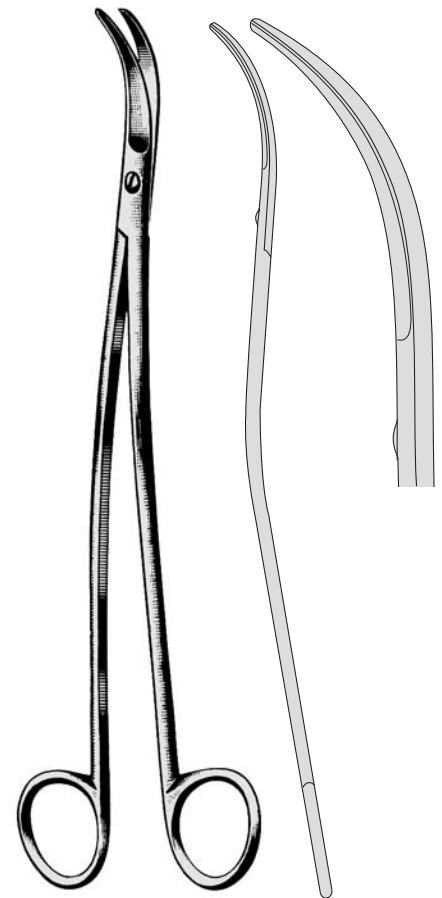

SATINSKY
 13.0577 24,5 cm

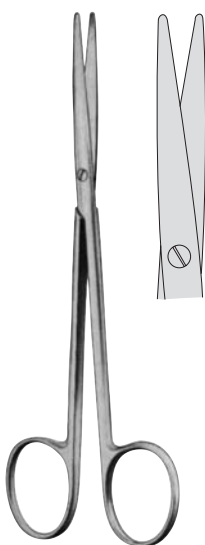

METZENBAUM-BABY
 13.0594 11,5 cm
 13.0596 13,0 cm
 13.0598 14,5 cm

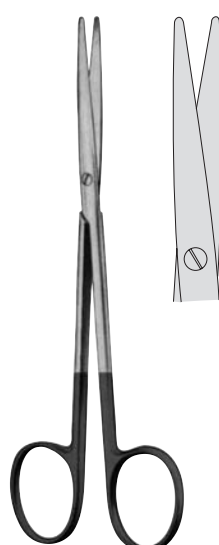

**METZENBAUM-BABY
 SUPERCUT (SC)**
 13.0594SC 11,5 cm
 13.0598SC 14,5 cm



METZENBAUM-BABY
 13.0595 11,5 cm
 13.0597 13,0 cm
 13.0599 14,5 cm



**METZENBAUM-BABY
 SUPERCUT (SC)**
 13.0595SC 11,5 cm
 13.0599SC 14,5 cm

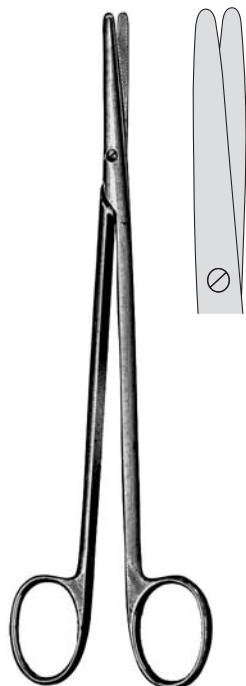

METZENBAUM

13.0600	14,5 cm
13.0602	18,0 cm
13.0604	20,0 cm
13.0606	23,0 cm
13.0608	25,0 cm
13.0610	28,0 cm
13.0612	30,0 cm

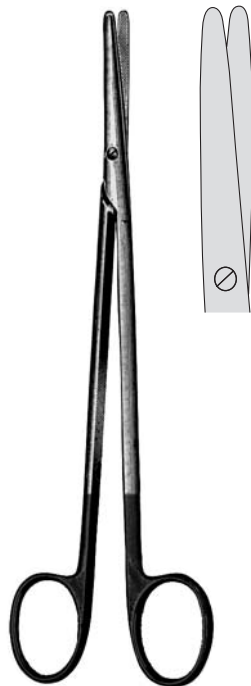

**METZENBAUM
 SUPERCUT (SC)**

13.0600SC	14,5 cm
13.0602SC	18,0 cm
13.0604SC	20,0 cm
13.0606SC	23,0 cm
13.0608SC	25,0 cm
13.0610SC	28,0 cm
13.0612SC	30,0 cm

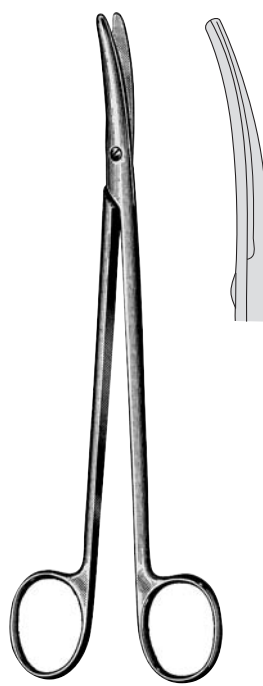

METZENBAUM

13.0601	14,5 cm
13.0603	18,0 cm
13.0605	20,0 cm
13.0607	23,0 cm
13.0609	25,0 cm
13.0611	28,0 cm
13.0613	30,0 cm

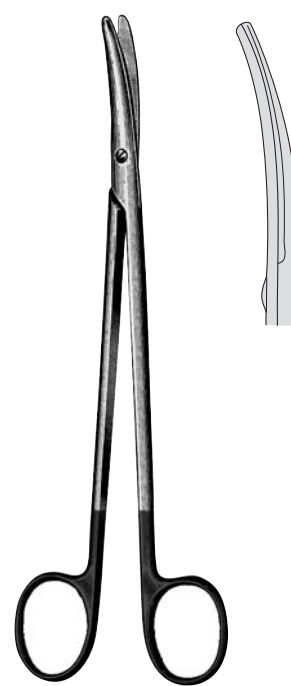

**METZENBAUM
 SUPERCUT (SC)**

13.0601SC	14,5 cm
13.0603SC	18,0 cm
13.0605SC	20,0 cm
13.0607SC	23,0 cm
13.0608SC	25,0 cm
13.0611SC	28,0 cm
13.0613SC	30,0 cm

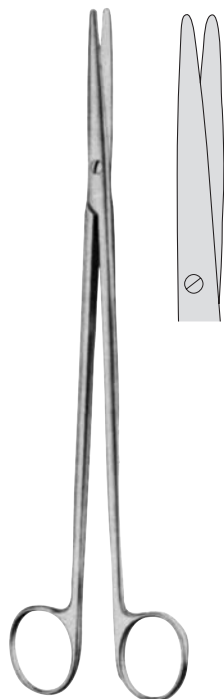

METZENBAUM-FINO

13.0660	14,5 cm
13.0662	18,0 cm
13.0664	20,0 cm
13.0666	23,0 cm



**METZENBAUM-FINO
 SUPERCUT (SC)**

13.0660SC	14,5 cm
13.0662SC	18,0 cm
13.0664SC	20,0 cm
13.0666SC	23,0 cm

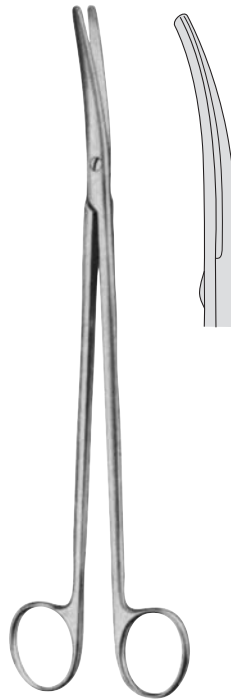

METZENBAUM-FINO

13.0661	14,5 cm
13.0663	18,0 cm
13.0665	20,0 cm
13.0667	23,0 cm



**METZENBAUM-FINO
 SUPERCUT (SC)**

13.0661SC	14,5 cm
13.0663SC	18,0 cm
13.0665SC	20,0 cm
13.0667SC	23,0 cm

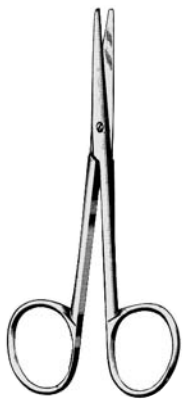

LEXER-BABY

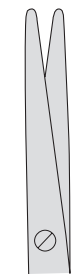

13.0700
10 cm

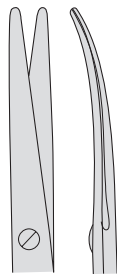

13.0701
10 cm



LAHEY-METZENBAUM



13.0752
15 cm

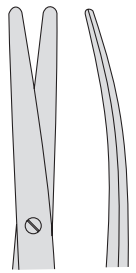

13.0753
15 cm

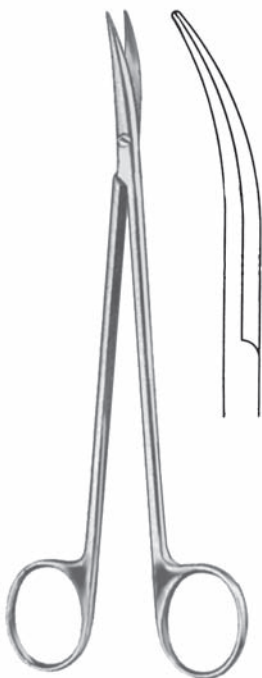

DE BAKEY
13.0757
17 cm



TOENNIS



13.0760
18 cm



13.0761
18 cm



TOENNIS-ADSON
13.0765 18 cm

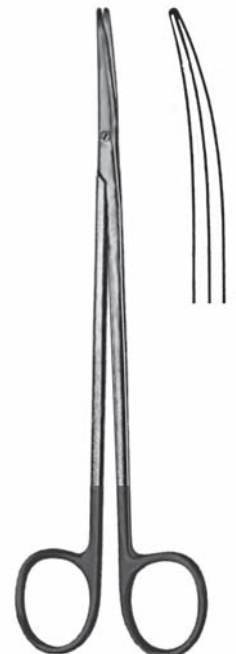

**TOENNIS-ADSON
SUPERCUT (SC)**
13.0765SC 18 cm



**REYNOLDS
(JAMESON)**



**REYNOLDS
(JAMESON)
SUPERCUT (SC)**



13.0770 15 cm
13.0770SC 15 cm
13.0772 18 cm

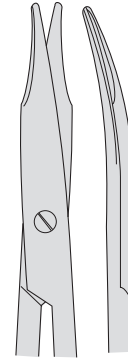

13.0771 15 cm
13.0771SC 15 cm
13.0773 18 cm

gezahnt / serrated / dentelées / dentada



**JAMESON
13.0780**

15 cm
 gerade/straight/droits/rectas



13.0781
15 cm
13.0783
18 cm
 gebogen
 curved
 courbe
 curva



**JAMESON
SUPERCUT (SC)**



13.0781SC
15 cm
 gebogen
 curved
 courbe
 curva

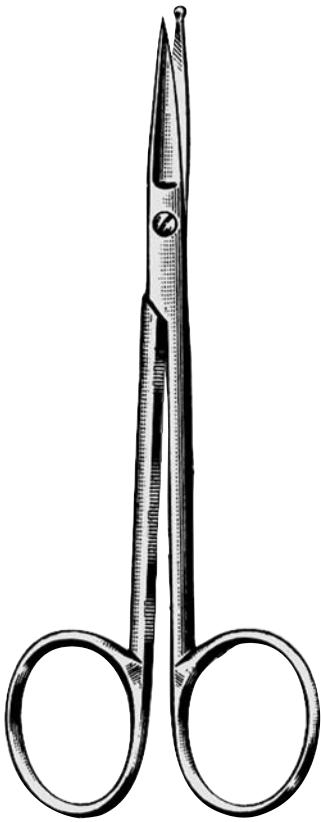

VASCULAR
13.1020 11 cm



BOWMAN
13.1030 11 cm

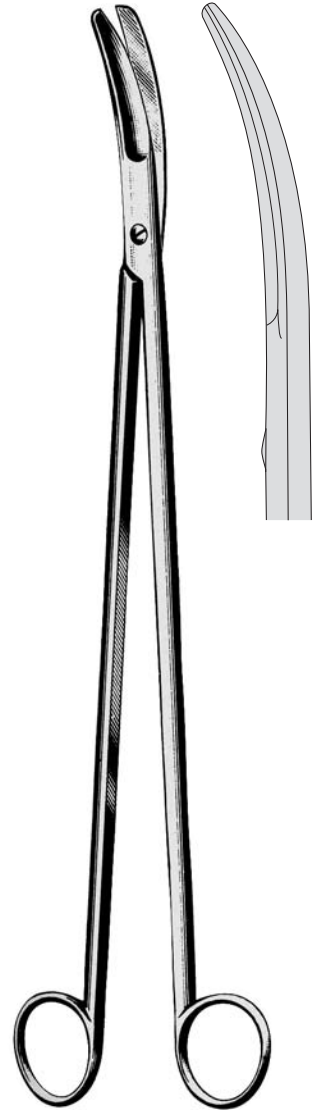

CRAFOORD
13.1081 30 cm



**HEGEMANN-
DIETRICH**



13.1090 13,5 cm /25°

13.1100 19 cm /25°

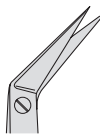

13.1091 13,5 cm /45°

13.1101 19 cm /45°

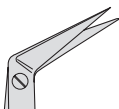

13.1092 13,5 cm /60°

13.1102 19 cm /60°

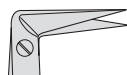

13.1093 13,5 cm /90°

13.1103 19 cm /90°

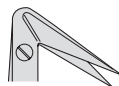

13.1104 19 cm /120°



HEGEMANN

13.1105 19 cm 125°



ARTERIOTOMY

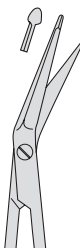

13.1110

18 cm 25°

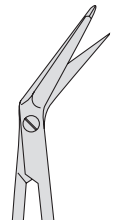

13.1111

18 cm 45°

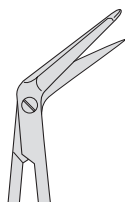

13.1112

18 cm 60°



13.1113

18 cm 90°

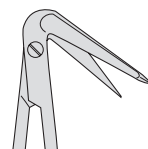

13.1114

18 cm 125°

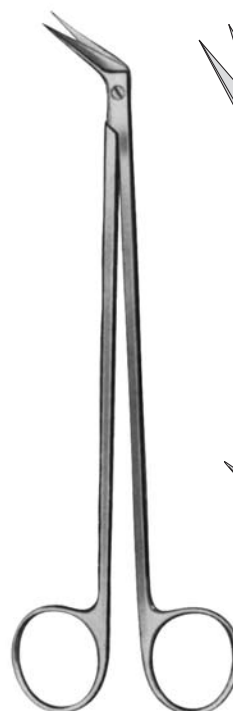

POTTS-SMITH

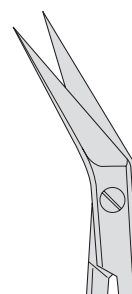

13.1130

19 cm 25°

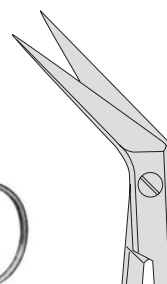

13.1131

19 cm 45°

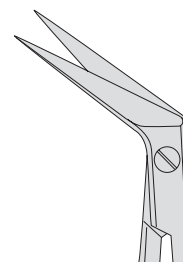

13.1132

19 cm 60°

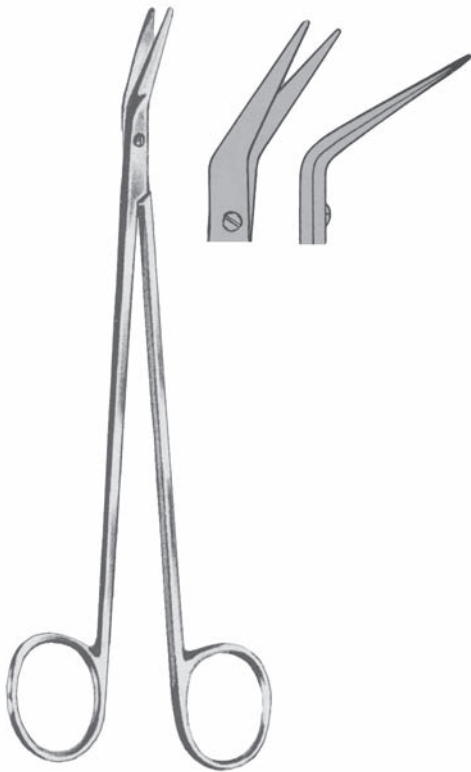

POTTS-SMITH
 13.1133
 19 cm



DEBAKEY

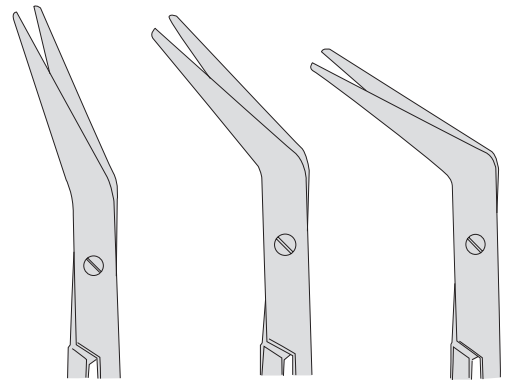

13.1150
 16 cm 25°
13.1160
 23 cm 25°

13.1151
 16 cm 45°
13.1161
 23 cm 45°

13.1152
 16 cm 60°
13.1162
 23 cm 60°



DEBAKEY
 13.1165
 16 cm 25°

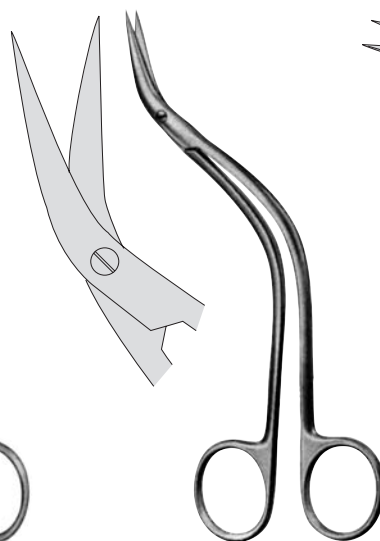

DEBAKEY
 13.1166
 16 cm 45°



FAVOLORO
 13.1170 15 cm



POTTS-DE-MARTEL

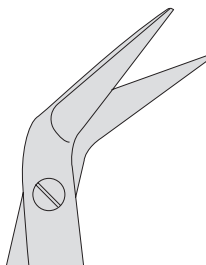

13.1180 21 cm /60°

13.1182 24 cm /60°

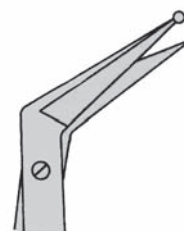

13.1190 18 cm /60°

1 Blatt geknöpft

1 probe-pointed blade

1 lame noutonée

1 hoja botonada

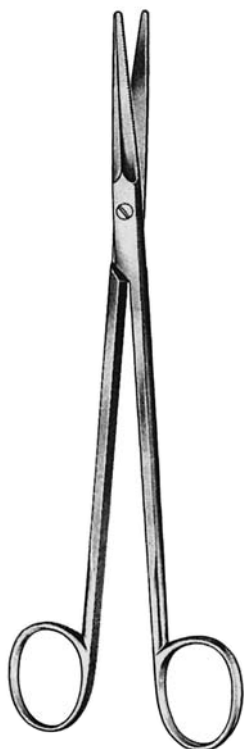

GORNEY
13.3010 - 13.3015



13.3010

12,5 cm



13.3014

19 cm



13.3015

19 cm

gezahnt / serrated / dentelées / dentada



IRIS
13.5000
11,5 cm

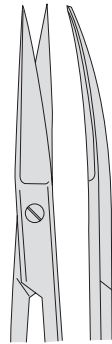

IRIS
13.5001
11,5 cm



IRIS
13.5007
11,5 cm



STRABISMUS
13.5010
11,5 cm

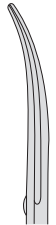

STRABISMUS
13.5011
11,5 cm



GOLDMAN-FOX
13.5020
13 cm

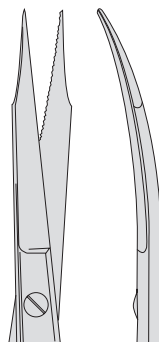

GOLDMAN-FOX
13.5021
13 cm



BABY-LEXER
13.5030
10 cm



BABY-LEXER
13.5031
10 cm



RAGNELL
13.5041
11,5 cm



MAYO
 13.5201 14,5 cm
 13.5203 17 cm
 13.5205 23 cm



MAYO-LEXER
 13.5221 16 cm



MAYO-STILLE
 13.5211 15 cm
 13.5213 17 cm

MAYO
 13.5200 14,5 cm
 13.5202 17 cm
 13.5204 23 cm

MAYO-LEXER
 13.5220 16 cm

MAYO-STILLE
 13.5210 15 cm
 13.5212 17 cm



MAYO-HARRINGTON
 13.5241 23 cm
 13.5243 28 cm

MAYO-HARRINGTON
 13.5240 23 cm
 13.5242 28 cm

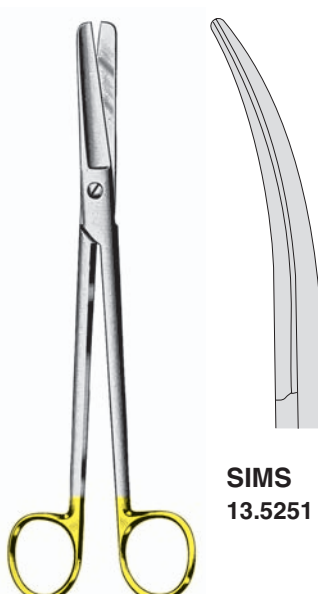

SIMS
 13.5251 23 cm

SIMS
 13.5250 23 cm

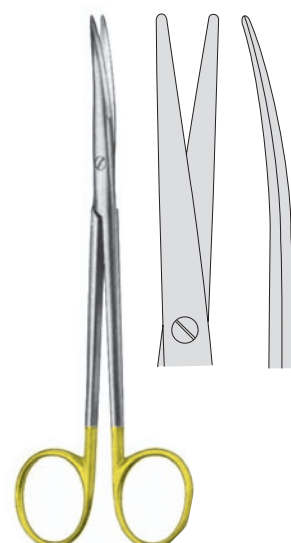

TOENNIS-ADSON
 13.5291 18 cm

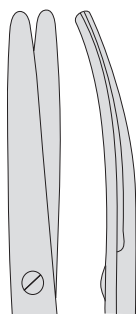

METZENBAUM

- 13.5301 14,5 cm
- 13.5311 18 cm
- 13.5321 20 cm
- 13.5331 23 cm
- 13.5361 25 cm
- 13.5371 28 cm
- 13.5381 30 cm

METZENBAUM

- 13.5300 14,5 cm
- 13.5310 18 cm
- 13.5320 20 cm
- 13.5330 23 cm
- 13.5360 25 cm
- 13.5370 28 cm
- 13.5380 30 cm

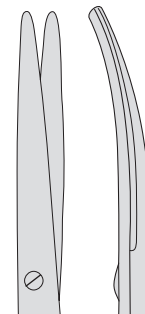

METZENBAUM-FINO

- 13.5305 14,5 cm
- 13.5315 18 cm
- 13.5325 20 cm
- 13.5335 23 cm
- 13.5365 25 cm
- 13.5375 28 cm

METZENBAUM-FINO

- 13.5304 14,5 cm
- 13.5314 18 cm
- 13.5324 20 cm
- 13.5334 23 cm
- 13.5364 25 cm
- 13.5374 28 cm

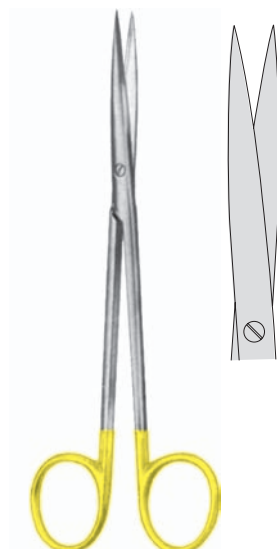

METZENBAUM X-FINO

- 13.5308 14,5 cm
- 13.5318 18 cm
- 13.5328 20 cm
- 13.5338 23 cm

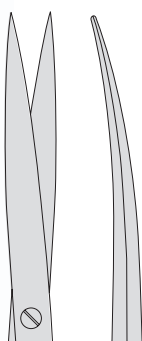
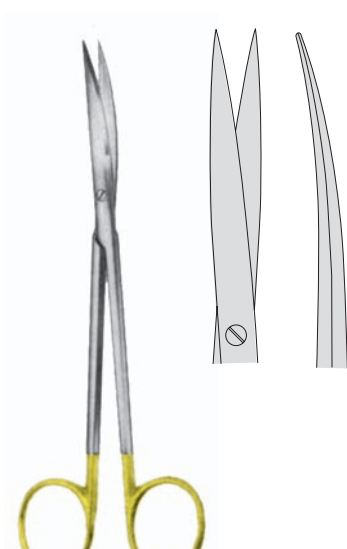

METZENBAUM X-FINO

- 13.5309 14,5 cm
- 13.5319 18 cm
- 13.5329 20 cm
- 13.5339 23 cm

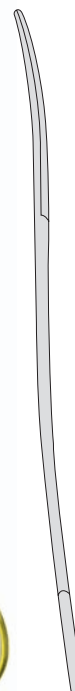
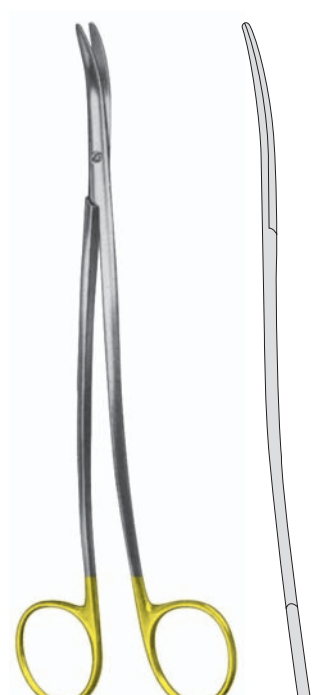

METZENBAUM

- 13.5313 18 cm
- 13.5323 20 cm
- 13.5333 23 cm

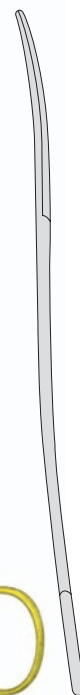
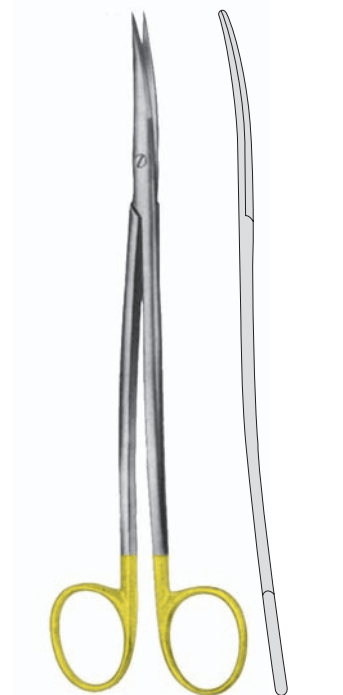

METZENBAUM-FINO

- 13.5317 18 cm
- 13.5327 20 cm
- 13.5337 23 cm



POTTS-SMITH

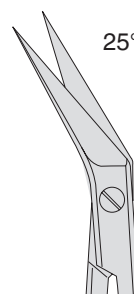

25°

POTTS-SMITH
13.5600 19 cm

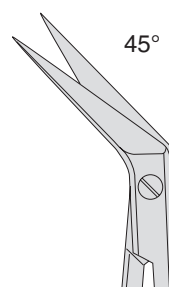

45°

POTTS-SMITH
13.5601 19 cm

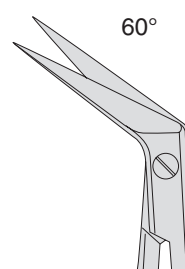

60°

POTTS-SMITH
13.5602 19 cm

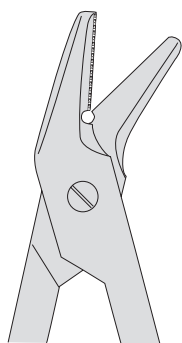

UNIVERSAL
13.5401 12,5 cm



DEBAKEY

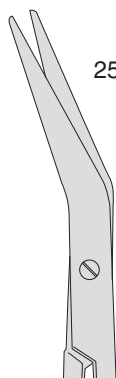

25°

DEBAKEY
13.5610 19 cm
13.5620 23 cm
13.5630 28 cm

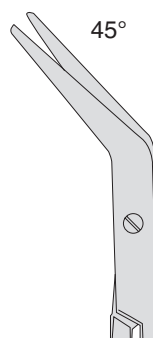

45°

DEBAKEY
13.5611 19 cm
13.5621 23 cm
13.5631 28 cm

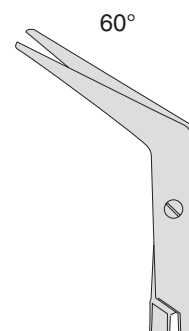

60°

DEBAKEY
13.5612 19 cm
13.5622 23 cm
13.5632 28 cm

T = TITAN



GRAEFE
14.0010 10 cm



GRAEFE
14.0011 10 cm

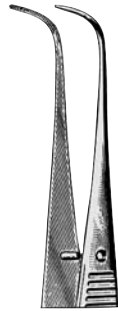

GRAEFE
14.0013 10 cm



ADSON-MICRO
14.0030 12 cm
14.0032 15 cm

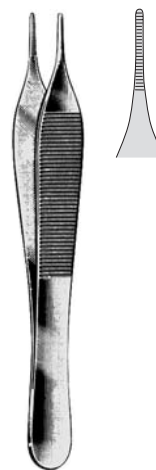

ADSON
14.0040 12 cm
14.0040T 12 cm
14.0042 15 cm
14.0042T 15 cm



McINDOE
14.0070 15 cm
14.0070T 15 cm



FINO
14.0101 11,5 cm
14.0102 13 cm
14.0103 14,5 cm
14.0104 15 cm
14.0105 16 cm
14.0107 18 cm
14.0108 20 cm
14.0109 25 cm



DRESSING
14.0120 10,5 cm
14.0121 11,5 cm
14.0122 13 cm
14.0123 14,5 cm
14.0123T 14,5 cm
14.0124 15 cm
14.0125 16 cm
14.0127 18 cm
14.0128 20 cm
14.0128T 20 cm
14.0129 25 cm
14.0130 30 cm



BLANK
14.0142 13 cm
14.0143 14,5 cm
14.0144 16 cm



BROPHY
14.0300 20 cm



BROPHY
14.0301 20 cm

T = TITAN



CUSHING
 14.0310 18 cm



CUSHING
 14.0311 18 cm



GERALD
 14.0320 18 cm



GERALD
 14.0321 18 cm



GERALD
 14.0325 18 cm

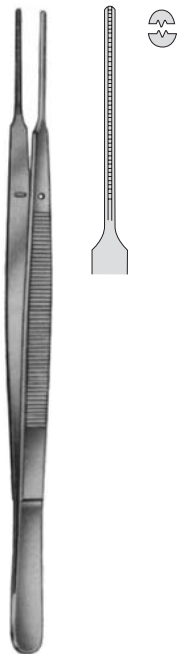

DEBAKEY-GERALD
 14.0328 18 cm



DUEHRSEN
 14.0330 20 cm



POTTS-SMITH
 14.0350 18 cm
14.0350T 18 cm
 14.0352 21 cm
14.0352T 21 cm
 14.0354 25 cm
14.0354T 25 cm



POTTS-SMITH
 14.0351 18 cm
 14.0353 21 cm



WAUGH
14.0370
20 cm



MIKRO
14.0380-14.0384
15.5 cm

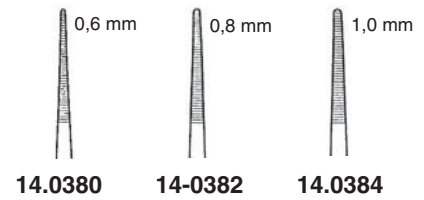

T = TITAN



GRAEFE
 14.0510
 10 cm 1x2

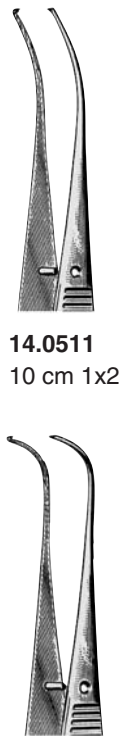

14.0511
 10 cm 1x2

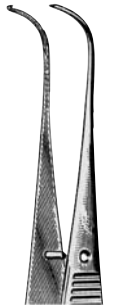

14.0513
 10 cm 1x2



ADSON-MICRO
 14.0530 12 cm
 14.0532 15 cm

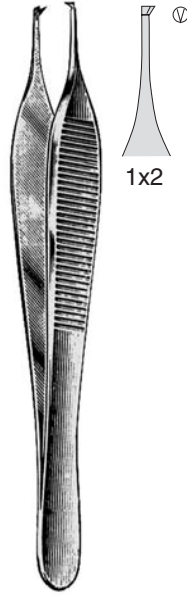

ADSON
 14.0540 12 cm
14.0540T 12 cm
 14.0542 15 cm

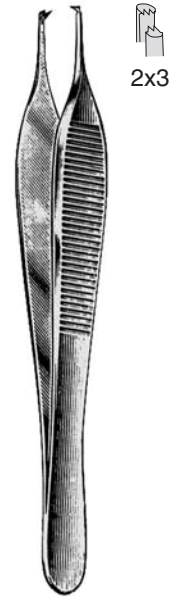

ADSON
 14.0541 12 cm

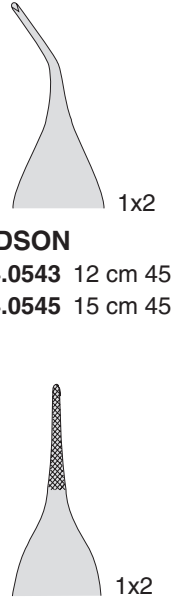

ADSON
 14.0543 12 cm 45°
 14.0545 15 cm 45°

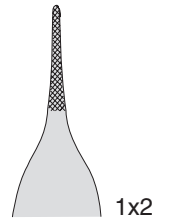

ADSON
 14.0550 12 cm



ADSON-DEBAKEY
 14.0546 12,5 cm
 14.0547 15 cm



ADSON-GRAEFE
 14.0548 12 cm



GILLIES
 14.0570 15 cm
14.0570T 15 cm



TISSUE-FINO

- 14.0600 10,5 cm 1x2
- 14.0601 11,5 cm 1x2
- 14.0602 13 cm 1x2
- 14.0603 14,5 cm 1x2
- 14.0604 15 cm 1x2
- 14.0605 16 cm 1x2
- 14.0607 18 cm 1x2
- 14.0608 20 cm 1x2
- 14.0609 25 cm 1x2

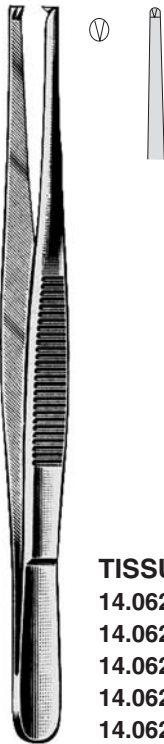

TISSUE

- 14.0620 10,5 cm 1x2
- 14.0621 11,5 cm 1x2
- 14.0622 13 cm 1x2
- 14.0623 14,5 cm 1x2
- 14.0625 16 cm 1x2
- 14.0627 18 cm 1x2
- 14.0628 20 cm 1x2
- 14.0629 25 cm 1x2
- 14.0630 30 cm 1x2



TISSUE

- 14.0653 14,5 cm 1x2

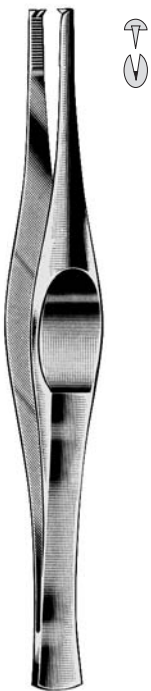

FERRIS-SMITH

- 14.0790 18 cm 1x2

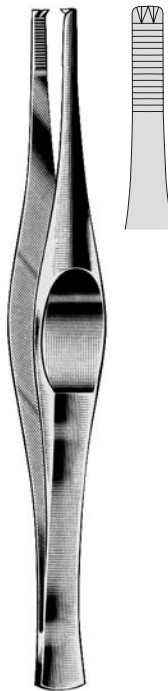

FERRIS-SMITH

- 14.0792 18 cm 2x3



BROPHY

- 14.0800 20 cm 1x2



BROPHY

- 14.0801 20 cm 1x2



CUSHING
14.0810 18 cm 1x2



GERALD
14.0820 18 cm 1x2



GERALD
14.0821 18 cm 1x2



GERALD
14.0825 18 cm 1x2

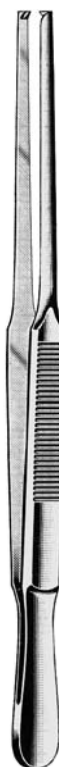

DUEHRSEN
14.0830 20 cm 1x2



POTTS-SMITH
14.0850 18 cm 1x2
14.0852 21 cm 1x2
14.0854 25 cm 1x2



POTTS-SMITH
14.0851 18 cm 1x2
14.0853 21 cm 1x2
14.0855 25 cm 1x2



ALDERKREUZ
14.0866 15 cm 2x3
14.0867 20 cm 2x3



ALDERKREUZ
14.0868 15 cm 4x5
14.0869 20 cm 4x5

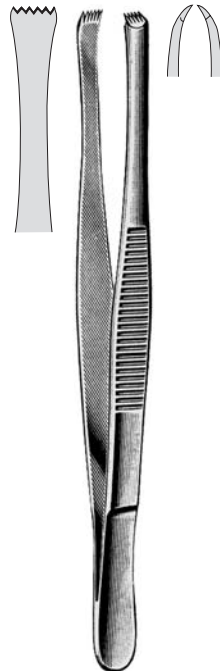

LERCHE
14.0880 15 cm 5x6

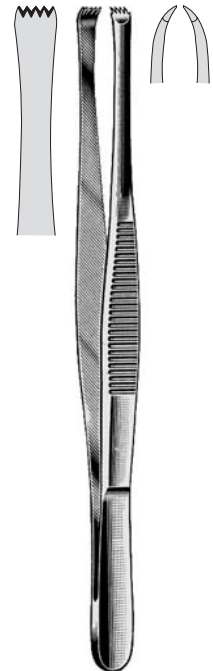

STONE
14.0885 15 cm 4x5

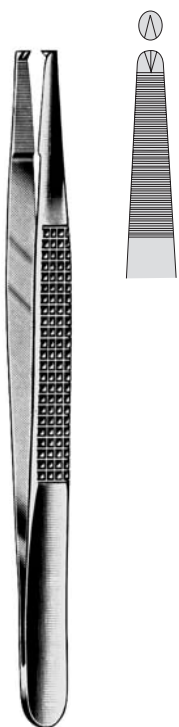

BONNEY
14.0890
18 cm 1x2

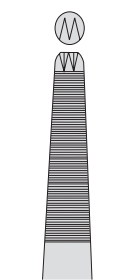

BONNEY
14.0892
18 cm 2x3



NELSON
14.0895 15 cm
14.0896 20 cm
14.0897 23 cm

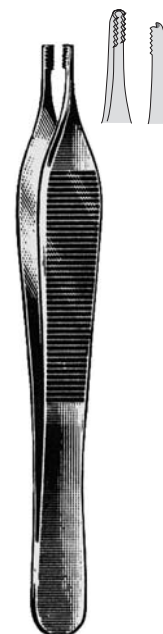

ADSON-BROWN
14.0900 12 cm 9x9



BROWN
14.0910 15 cm
14.0912 20 cm
14.0914 25 cm



LANE
 14.0920 14,5 cm 1x2
 14.0922 20 cm 1x2



LANE
 14.0925 14,5 cm 2x3
 14.0927 20 cm 2x3



RUSSIAN
 14.0930 15 cm
 14.0932 20 cm
 14.0934 25 cm

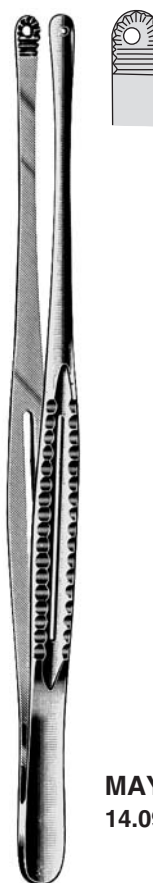

MAYO-RUSSIAN
 14.0940 23 cm



WANGENSTEEN
 14.0948 23 cm

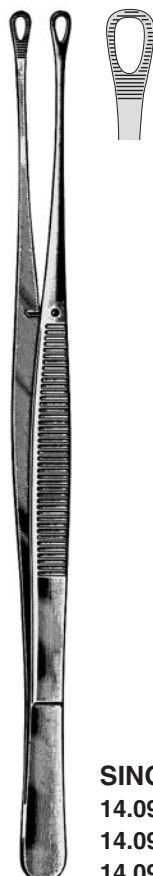

SINGLEY (TUTTLE)
 14.0950 15 cm
 14.0952 18 cm
 14.0954 23 cm

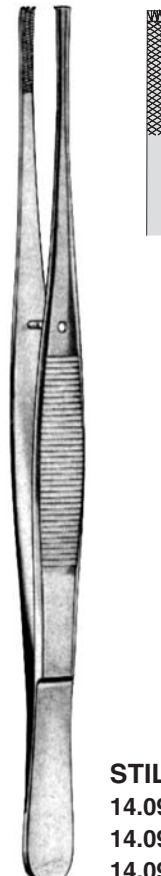

STILLE-BARRAYA
 14.0960 18 cm
 14.0962 20 cm
 14.0964 25 cm



WAUGH
 14.0970 20 cm

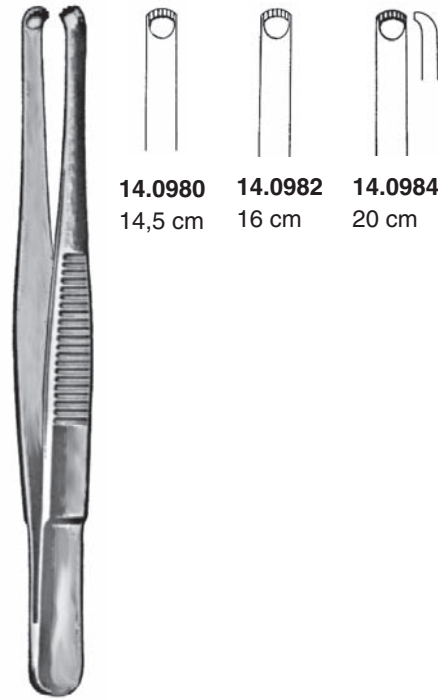

14.0980 14,5 cm
14.0982 16 cm
14.0984 20 cm

DURANTE

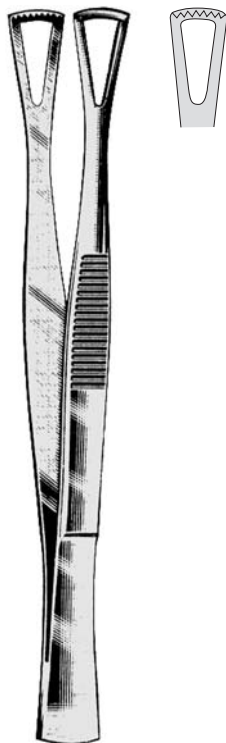

DUVAL
 14.0990 14,5 cm

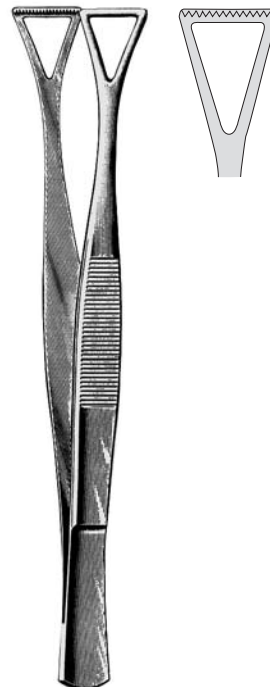

COLLIN-DUVAL
 14.0994 20 cm, 14 mm
 14.0996 20 cm, 18 mm
 14.0998 20 cm, 27 mm

T = TITAN



DEBAKEY

- 14.1000 15 cm / 1,5 mm
- 14.1002 20 cm / 1,5 mm
- 14.1004 24 cm / 1,5 mm



DEBAKEY

- 14.1007 T 16 cm / 1,5 mm
- 14.1008 T 20 cm / 1,5 mm
- 14.1009 T 24 cm / 1,5 mm



DEBAKEY

- 14.1010 15 cm/2 mm
- 14.1012 20 cm/2 mm
- 14.1014 24 cm/2 mm
- 14.1016 30 cm/2 mm

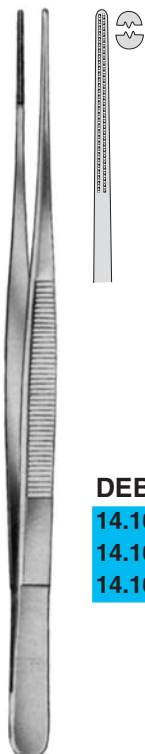

DEBAKEY

- 14.1017 T 16 cm/1,8 mm
- 14.1018 T 20 cm/1,8 mm
- 14.1019 T 24 cm/1,8 mm



DEBAKEY

- 14.1021 16 cm / 2 mm
- 14.1021T 16 cm / 2 mm
- 14.1023 20 cm / 2 mm
- 14.1023T 20 cm / 2 mm
- 14.1025 24 cm / 2 mm
- 14.1025T 24 cm / 2 mm
- 14.1027 30 cm / 2 mm
- 14.1027T 30 cm / 2 mm



DEBAKEY

- 14.1030 16 cm / 2,7 mm
- 14.1030T 16 cm / 2,7 mm
- 14.1032 20 cm / 2,7 mm
- 14.1032T 20 cm / 2,7 mm
- 14.1034 24 cm / 2,7 mm
- 14.1034T 24 cm / 2,7 mm
- 14.1036 30 cm / 2,7 mm
- 14.1036T 30 cm / 2,7 mm

T = TITAN



DEBAKEY

- 14.1040 15 cm /3,5 mm
- 14.1040T 15 cm /3,5 mm
- 14.1042 20 cm /3,5 mm
- 14.1042T 20 cm /3,5 mm
- 14.1044 24 cm /3,5 mm
- 14.1044T 24 cm /3,5 mm
- 14.1046 30 cm /3,5 mm
- 14.1046T 30 cm /3,5 mm



COOLEY

- 14.1050 15 cm /2 mm
- 14.1050T 15 cm /2 mm
- 14.1052 19 cm /2 mm
- 14.1052T 19 cm /2 mm
- 14.1054 24 cm /2 mm
- 14.1054T 24 cm /2 mm



DEBAKEY

- 14.1060 15 cm /1 mm
- 14.1060T 15 cm /1 mm
- 14.1062 20 cm /1 mm
- 14.1062T 20 cm /1 mm
- 14.1064 24 cm /1 mm
- 14.1064T 24 cm /1 mm



DEBAKEY

- 28.0320 15 cm /1,2 mm TITAN
- 28.0320S 15 cm /1,2 mm
- 28.0322 18 cm /1,2 mm TITAN
- 28.0322S 18 cm /1,2 mm
- 28.0324 21 cm /1,2 mm TITAN
- 28.0324S 21 cm /1,2 mm
- 28.0330 15 cm /2,0 mm TITAN
- 28.0330S 15 cm /2,0 mm
- 28.0332 18 cm /2,0 mm TITAN
- 28.0332S 18 cm /2,0 mm
- 28.0334 21 cm /2,0 mm TITAN
- 28.0334S 21 cm /2,0 mm



ADSON
 14.2000 12 cm
 14.2002 15 cm

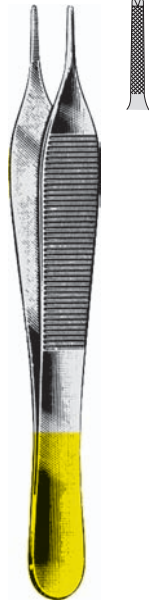

ADSON
 14.2005 12 cm 1x2
 14.2007 15 cm 1x2



CUSHING
 14.2020 18 cm



CUSHING
 14.2021 18 cm



CUSHING
 14.2023 19 cm



POTTS-SMITH
 14.2049 15 cm
 14.2050 18 cm
 14.2052 21 cm
 14.2054 25 cm



WANGENSTEEN
 14.2070 15 cm
 14.2072 23 cm
 14.2074 25 cm



DRESSING
 14.2103 14,5 cm
 14.2107 18 cm
 14.2108 20 cm
 14.2109 25 cm



DRESSING
 14.2123 14,5 cm
 14.2127 18 cm
 14.2128 20 cm
 14.2129 25 cm



DEBAKEY
14.2200
 15 cm / 1,5 mm
14.2202
 19 cm / 1,5 mm
14.2204
 24 cm / 1,5 mm



DEBAKEY
14.2210
 15 cm / 2 mm
14.2212
 19 cm / 2 mm
14.2214
 24 cm / 2 mm

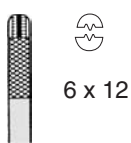

DEBAKEY
14.2220
 15 cm / 2,7 mm
14.2222
 19 cm / 2,7 mm
14.2224
 24 cm / 2,7 mm

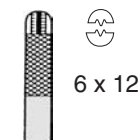

DEBAKEY
14.2230
 15 cm / 3,5 mm
14.2232
 19 cm / 3,5 mm
14.2234
 24 cm / 3,5 mm



DEBAKEY
14.2240
 15 cm / 2 mm
14.2242
 19 cm / 2 mm
14.2244
 24 cm / 2 mm



OEHLER
14.2623 14 cm
14.2625 16 cm
14.2627 18 cm
14.2628 20 cm
14.2629 25 cm
14.2630 30 cm



GERALD
14.2320 18 cm



GERALD
14.2820 18 cm 1x2



BONNEY
14.2890 18 cm 1x2



ADSON-BROWN
14.2900 12 cm 9x9



COAGULATING

14.3000 11 cm/0,25 mm

14.3002 11 cm/0,6 mm



COAGULATING

14.3003 11 cm/0,25 mm

14.3005 11 cm/0,6 mm



COAGULATING

14.3007 11 cm/0,25 mm

14.3009 11 cm/0,6 mm



COAGULATING
14.3100 15 cm/0,3 mm
14.3110 15 cm/1,0 mm
14.3120 15 cm/2,0 mm



COAGULATING
14.3102 18 cm/0,3 mm
14.3112 18 cm/1,0 mm
14.3122 18 cm/2,0 mm



COAGULATING
14.3104 20 cm/0,3 mm
14.3114 20 cm/1,0 mm
14.3124 18 cm/2,0 mm



COAGULATING
14.3106 22 cm/0,3 mm
14.3116 22 cm/1,0 mm
14.3126 22 cm/2,0 mm



COAGULATING
14.3108 24 cm/0,3 mm
14.3118 24 cm/1,0 mm
14.3128 24 cm/2,0 mm



COAGULATING
14.3141 15 cm/0,3 mm
14.3151 15 cm/1,0 mm
14.3161 15 cm/2,0 mm



COAGULATING
14.3143 18 cm/0,3 mm
14.3153 18 cm/1,0 mm
14.3163 18 cm/2,0 mm



COAGULATING
14.3145 20 cm/0,3 mm
14.3155 20 cm/1,0 mm
14.3165 20 cm/2,0 mm



COAGULATING
14.3147 22 cm/0,3 mm
14.3157 22 cm/1,0 mm
14.3167 22 cm/2,0 mm



COAGULATING
14.3149 24 cm/0,3 mm
14.3159 24 cm/1,0 mm
14.3169 24 cm/2,0 mm

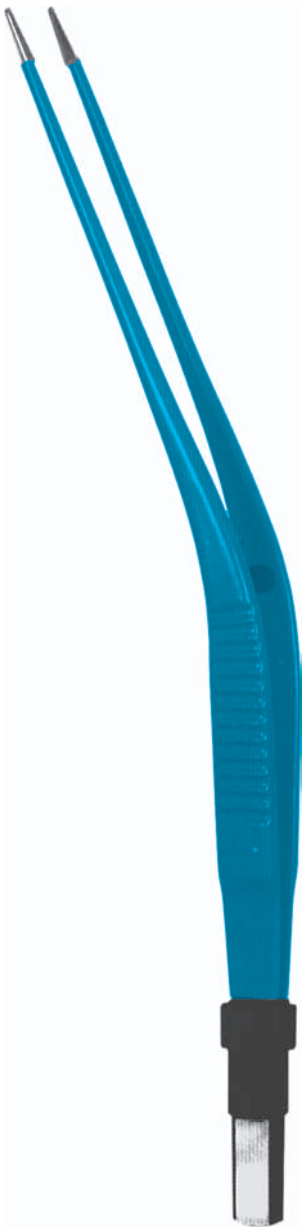

COAGULATING
14.3061 17 cm/0,3 mm
14.3071 17 cm/1,0 mm
14.3081 17 cm/2,0 mm



COAGULATING
14.3202 18 cm/0,3 mm
14.3212 18 cm/1,0 mm
14.3222 18 cm/2,0 mm



COAGULATING
14.3204 20 cm/0,3 mm
14.3214 20 cm/1,0 mm
14.3224 20 cm/2,0 mm



COAGULATING

14.3206 22 cm/0,3 mm

14.3216 22 cm/1,0 mm

14.3226 22 cm/2,0 mm



COAGULATING

14.3208 24 cm/0,3 mm

14.3218 24 cm/1,0 mm

14.3228 24 cm/2,0 mm

BIPOLAR-Kabel 3 m, f. Bipolpinzetten für Pinzetten mit Flachstecker
Cables 3 mtr. for Forceps with flat plug
Cordons 3 mtr. pour pinces avec fiches plats
Cables 3 mtr. para pinzas con clavijas plano



14.3900
2-Bananenstecker
2-banana-plug
fiche 2-bananas
clavija 2-bananas



14.3910
Model Erbe
Model Erbe
Modèle Erbe
Modelo Erbe



14.3920
Model Martin
Model Martin
Modèle Martin
Modelo Martin



14.3930
Model Valleylab
Model Valleylab
Modèle Valleylab
Modelo Valleylab



14.3940
Model Aesculap GK50
Model Aesculap GK50
Modèle Aesculap GK50
Modelo Aesculap GK50



14.3950
Model Codman CMC II
Model Codman CMC II
Modèle Codman CMC II
Modelo Codman CMC II



MICRO-CLIP
15.0001
10 x 2 mm
60 gr.



MICRO-CLIP
15.0002
8 x 2 mm
85 gr.



MICRO-CLIP
15.0003
6 x 1 mm
100 gr.



MICRO-CLIP
15.0004
4 x 0,75 mm
125 gr.



MICRO-CLIP
15.0005
6 x 1 mm
45°, 70 gr.



MICRO-CLIP
15.0006
6 x 1 mm
70 gr.



15.0008 14 cm



15.0009 18 cm

Anlegezangen
applying forceps
pinces à appliquer
pinzas para poner



JOHNS-HOPKINS
15.0040 23 cm
Anlegezangen
applying forceps
pinces à appliquer
pinzas para poner



DIEFFENBACH
15.0010 3,5 m



DIEFFENBACH
15.0011 3,5 cm



DIEFFENBACH
15.0012 5 cm



DIEFFENBACH
15.0013 5 cm



DIEFFENBACH
15.0014 6 cm

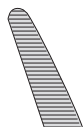

DIEFFENBACH
15.0015 6 cm



JOHNS-HOPKINS
15.0020 38 mm
15.0022 50 mm
15.0024 57 mm
15.0026 63 mm
15.0028 70 mm
15.0030 76 mm
15.0032 90 mm



JOHNS-HOPKINS
15.0021 38 mm
15.0023 50 mm
15.0025 57 mm
15.0027 63 mm
15.0029 70 mm
15.0031 76 mm
15.0033 90 mm



SCHWARTZ
15.0050 25 mm



SCHWARTZ
15.0051 25 mm



SCHWARTZ
15.0053 25 mm



MINI-SERREFINE
15.0060 28 mm



MINI-SERREFINE
15.0061 28 mm



SCHWARTZ
15.0058 19 cm



HARTMANN
15.0100 10 cm
15.0108 10 cm
glattes Maul
smooth jaws
lisses
lisas



HARTMANN
15.0101 10 cm



HARTMANN-MICRO
15.0102 10 cm



HARTMANN-MICRO
15.0103 10 cm



HARTMANN
15.0104 10 cm 1x2



HARTMANN
15.0105 10 cm 1x2

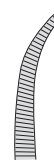

MOSQUITO
15.0118 12,5 cm
linkshändig/lefthanded
pour gaucher/para zurdo

15.0119 12,5 cm
linkshändig/lefthanded
pour gaucher/para zurdo

T = TITAN



15.0121 12,5 cm

15.0121T 12,5 cm

15.0125 14 cm

MOSQUITO

15.0120 12,5 cm

15.0120T 12,5 cm

15.0124 14 cm



15.0123

MICRO-MOSQUITO

15.0122 12,5 cm



15.0127 12,5 cm 1x2

15.0137 14 cm 1x2

MOSQUITO

15.0126 12,5 cm 1x2

15.0136 14 cm 1x2



15.0129 1x2

MICRO-MOSQUITO

15.0128 12,5 cm 1x2

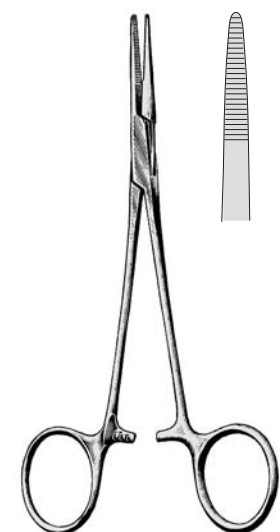

15.0131

PROVIDENCE-HOSPITAL

15.0130 14,5 cm

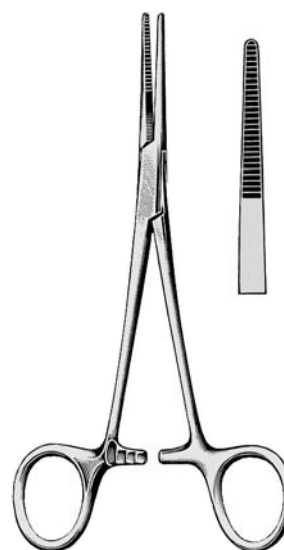

15.0201

15.0201T

KELLY

15.0200 14 cm

15.0200T 14 cm

T = TITAN



CRILE
15.0210 14 cm
15.0210T 14 cm



15.0211
15.0211T



CRILE-BABY

15.0212



15.0213



15.0214 1x2



15.0215 1x2

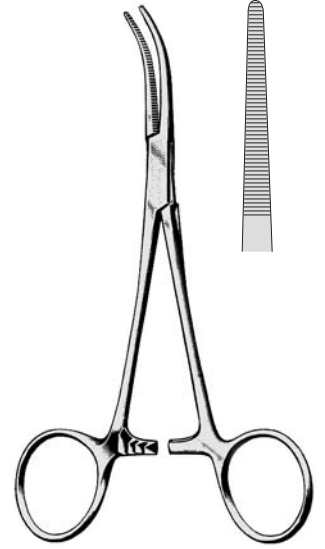

DANDY
15.0220 14,5 cm

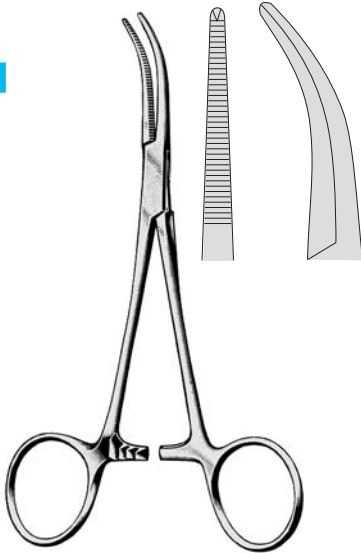

DANDY
15.0222 14,5 cm 1x2

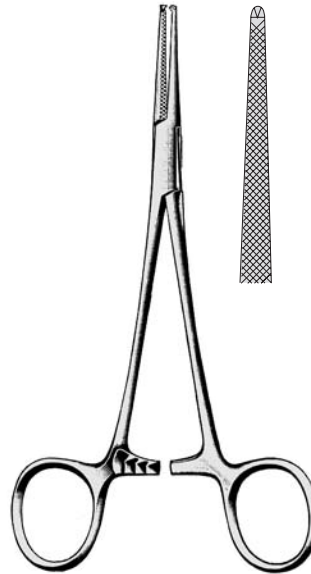

LOVELACE
15.0224 15,5 cm
15.0225 15,5 cm 1x2

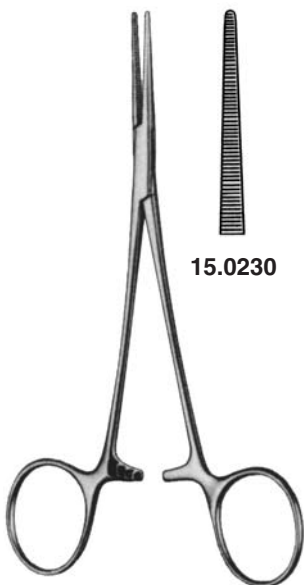

LERICHE
15 cm



15.0230



15.0231



15.0236 1x2



15.0237 1x2



RANKIN-KELLY
16 cm



15.0240



15.0241



RANKIN-CRILE
15.0250 16 cm



15.0251



RANKIN-CRILE
15.0252 16 cm 1x2



15.0253 1x2

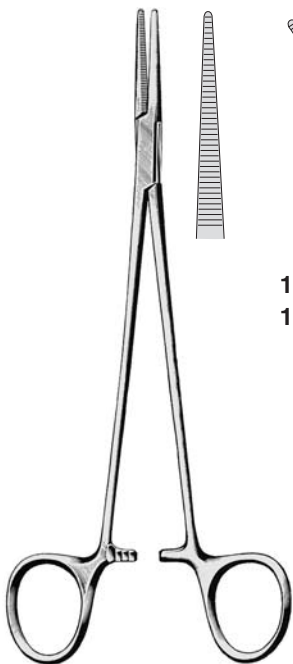

HALSTED
15.0300 18 cm
15.0302 21 cm



15.0301 18 cm
15.0303 21 cm

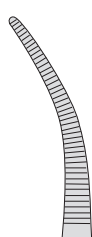

15.0306 18 cm 1x2
15.0308 21 cm 1x2

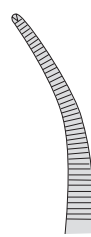

15.0307 18 cm 1x2
15.0309 21 cm 1x2

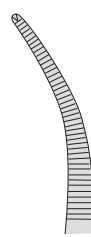

ADSON
15.0310 18,5 cm



15.0311

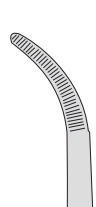



ADSON-BABY
15.0313 14 cm
15.0315 18 cm

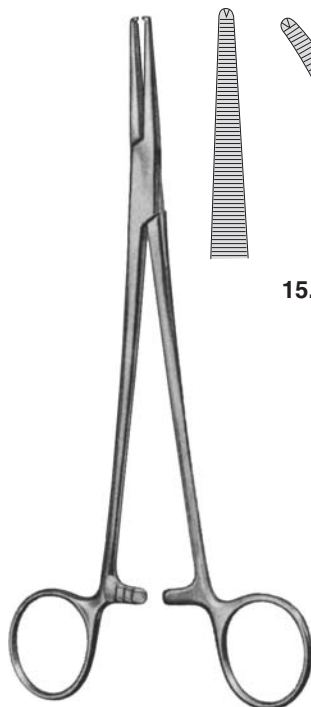

ADSON
15.0316 18,5 cm 1x2

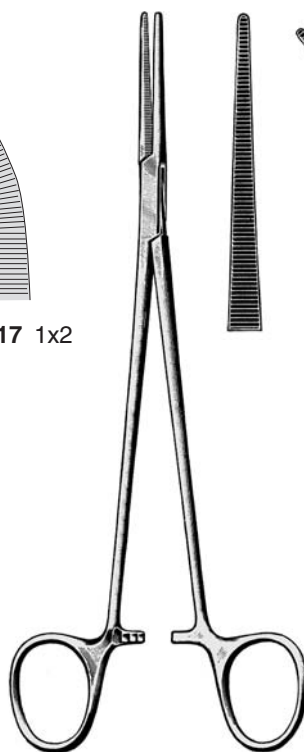

HEISS
15.0320 20 cm

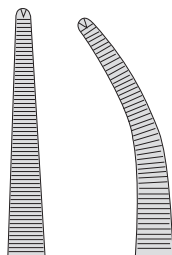

15.0317 1x2

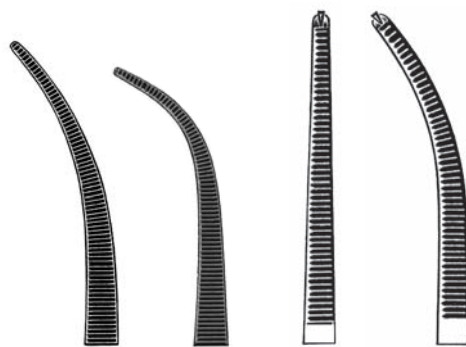

15.0321 15.0323 15.0324 15.0325
1x2 1x2

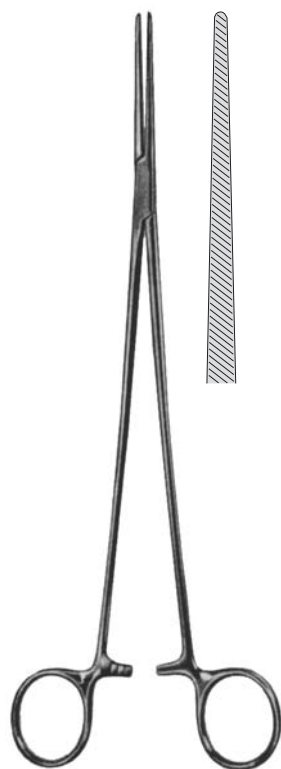

BENGOLEA
15.0360 20 cm
15.0362 26 cm

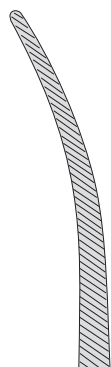

15.0361 20 cm
15.0363 26 cm

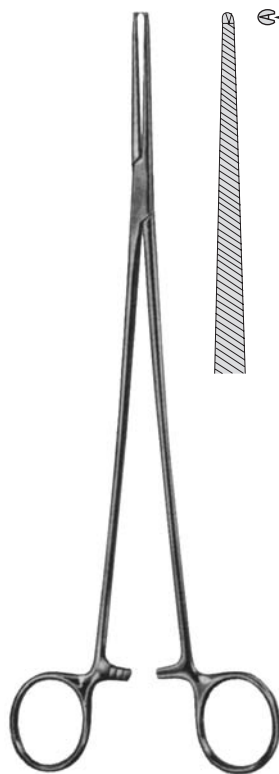

BENGOLEA
15.0364 20 cm 1x2
15.0366 26 cm 1x2

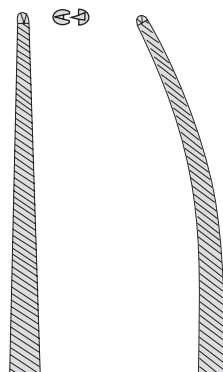

15.0365 20 cm 1x2
15.0367 26 cm 1x2



BRIDGE
15.0392 28 cm



15.0393
28 cm



15.0431 16 cm
15.0433 20 cm

ROCH-CARMALT

15.0430 16 cm
15.0432 20 cm

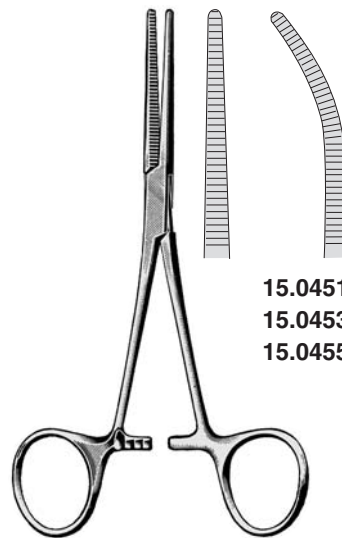

15.0451 13 cm
15.0453 14 cm
15.0455 16 cm

PEAN-FINO

15.0450 13 cm
15.0452 14 cm
15.0454 16 cm

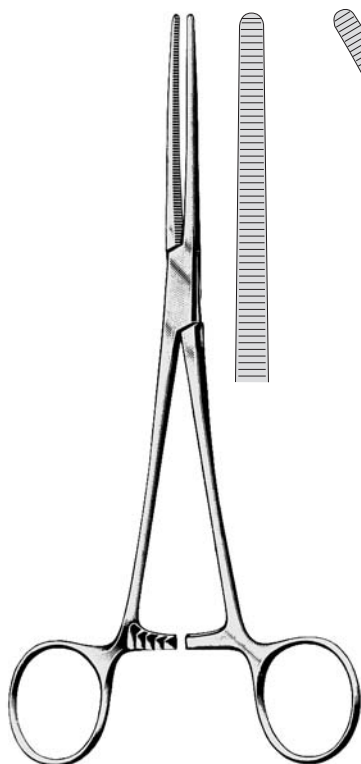

15.0459 13 cm
15.0461 14 cm
15.0463 16 cm
15.0465 18 cm
15.0467 20 cm
15.0469 22 cm
15.0471 24 cm
15.0473 26 cm
15.0477 30 cm

ROCHESTER-PEAN

15.0458 13 cm
15.0460 14 cm
15.0462 16 cm
15.0464 18 cm
15.0466 20 cm
15.0468 22 cm
15.0470 24 cm
15.0472 26 cm
15.0476 30 cm

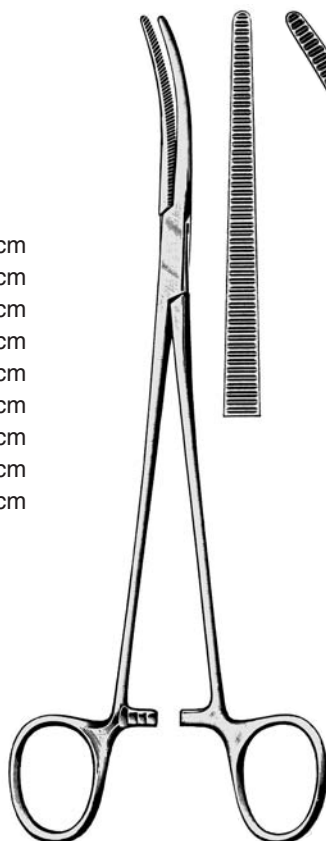

15.0481

ROBERTS

15.0480 22 cm

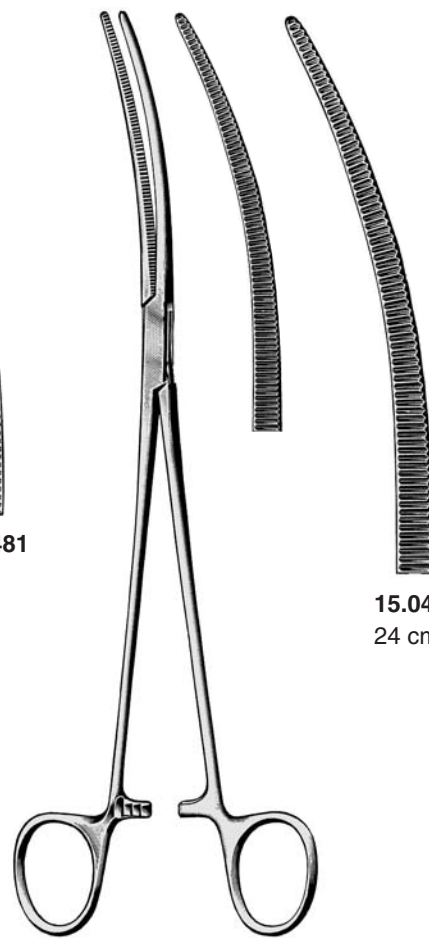

15.0494
24 cm

CRAFOORD

15.0492 18 cm

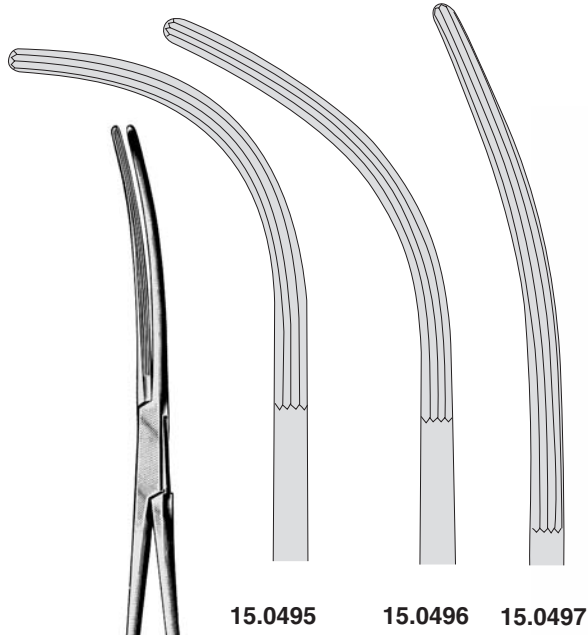

15.0495 15.0496 15.0497

CRAFOORD-SELLORS
24 cm



15.0501

SAROT
15.0500 24 cm

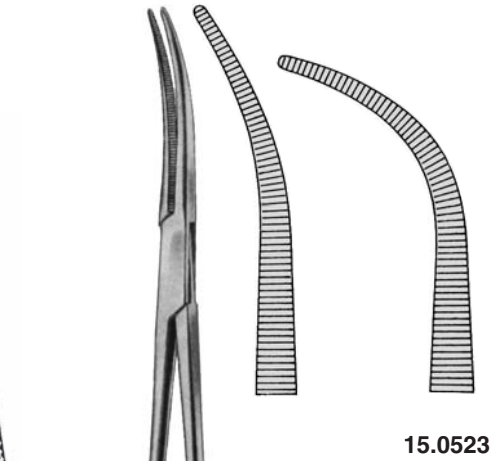

15.0523

ZENKER
15.0521 29,5 cm

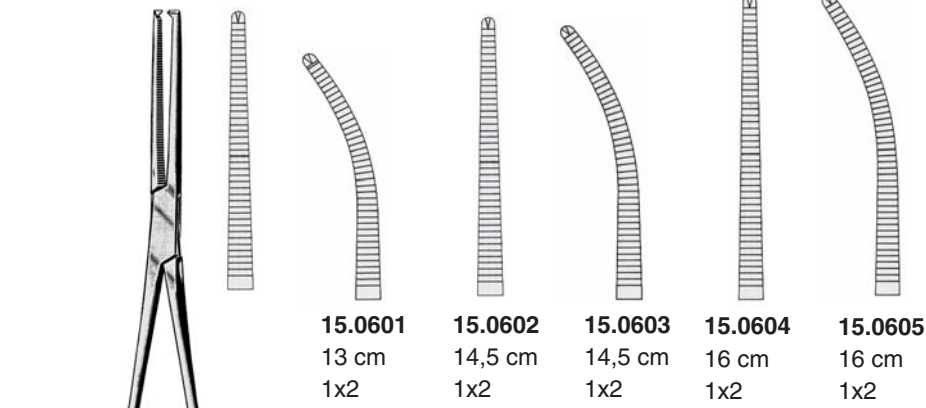

15.0601 13 cm 1x2
 15.0602 14,5 cm 1x2
 15.0603 14,5 cm 1x2
 15.0604 16 cm 1x2
 15.0605 16 cm 1x2

KOCHER
15.0600 13 cm 1x2

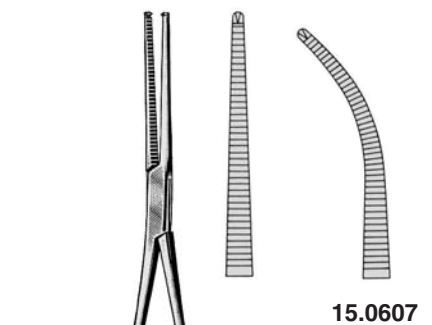

15.0607

KOCHER-FINO
15.0606 14 cm



ROCHESTER-OCHSNER

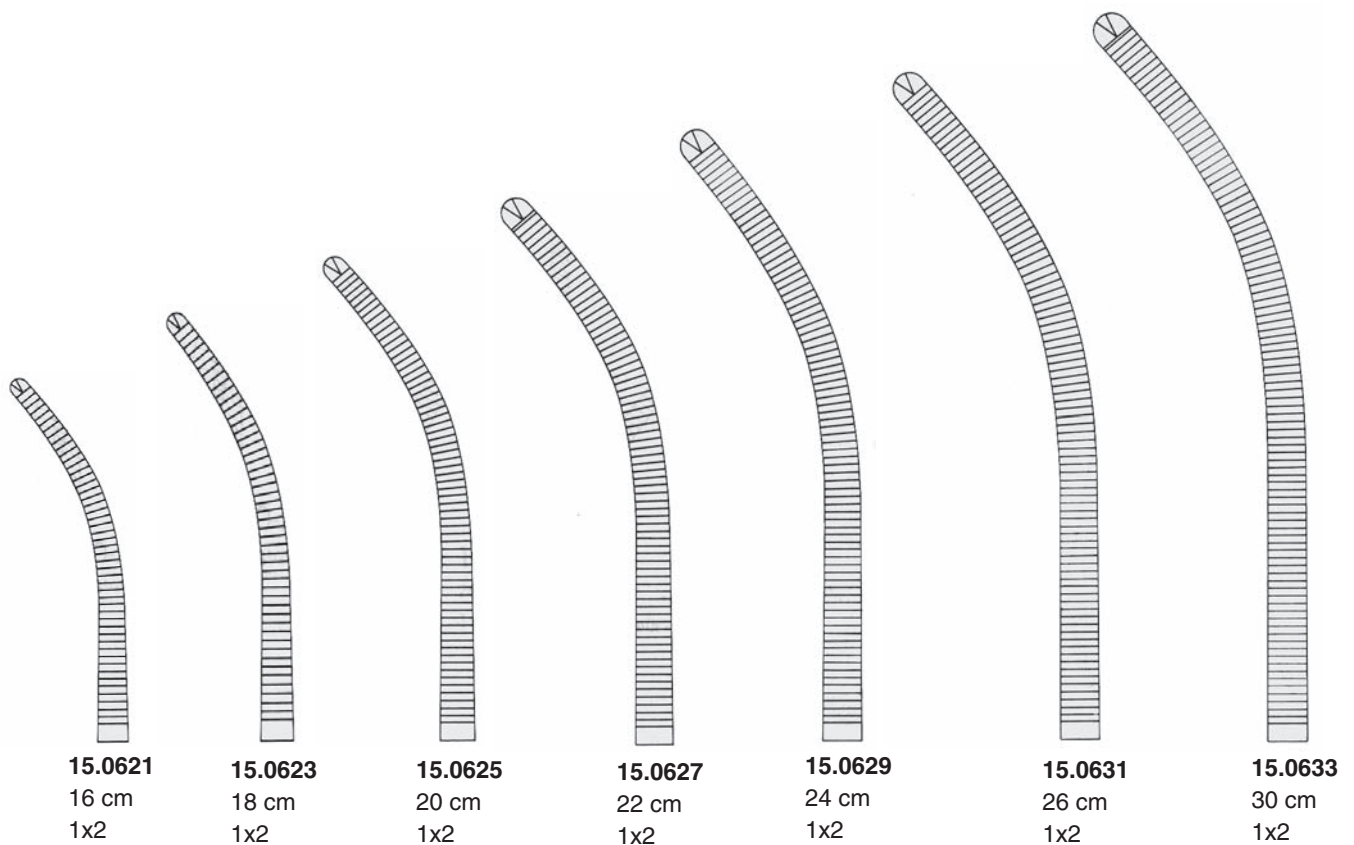
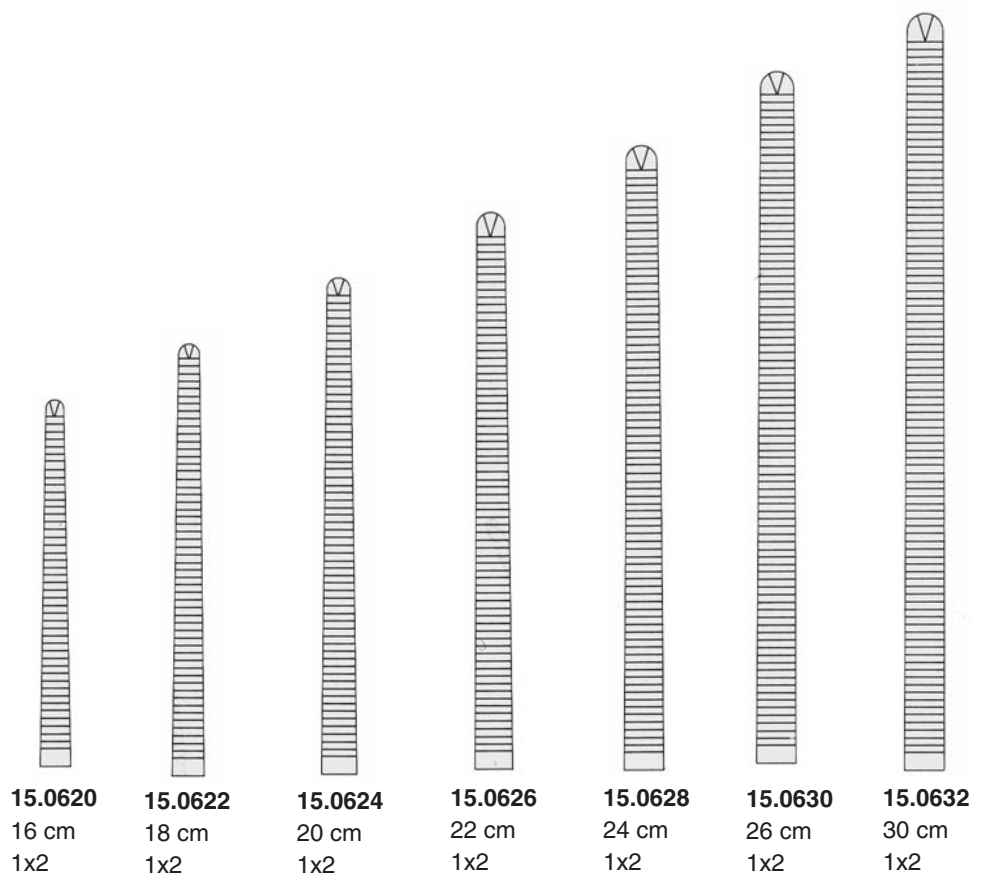

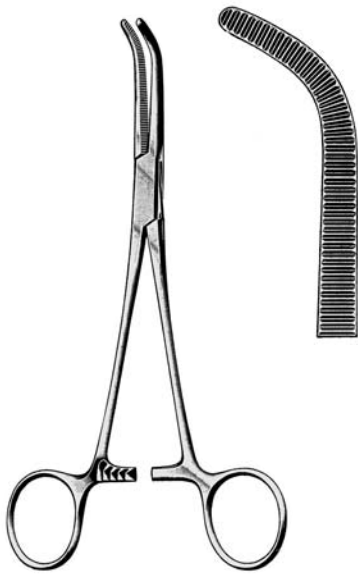

MIXTER-O'SHAUGHNESSY
 15.0701 15 cm
 15.0703 19 cm



OVERHOLT-BABY
 15.0720 14 cm

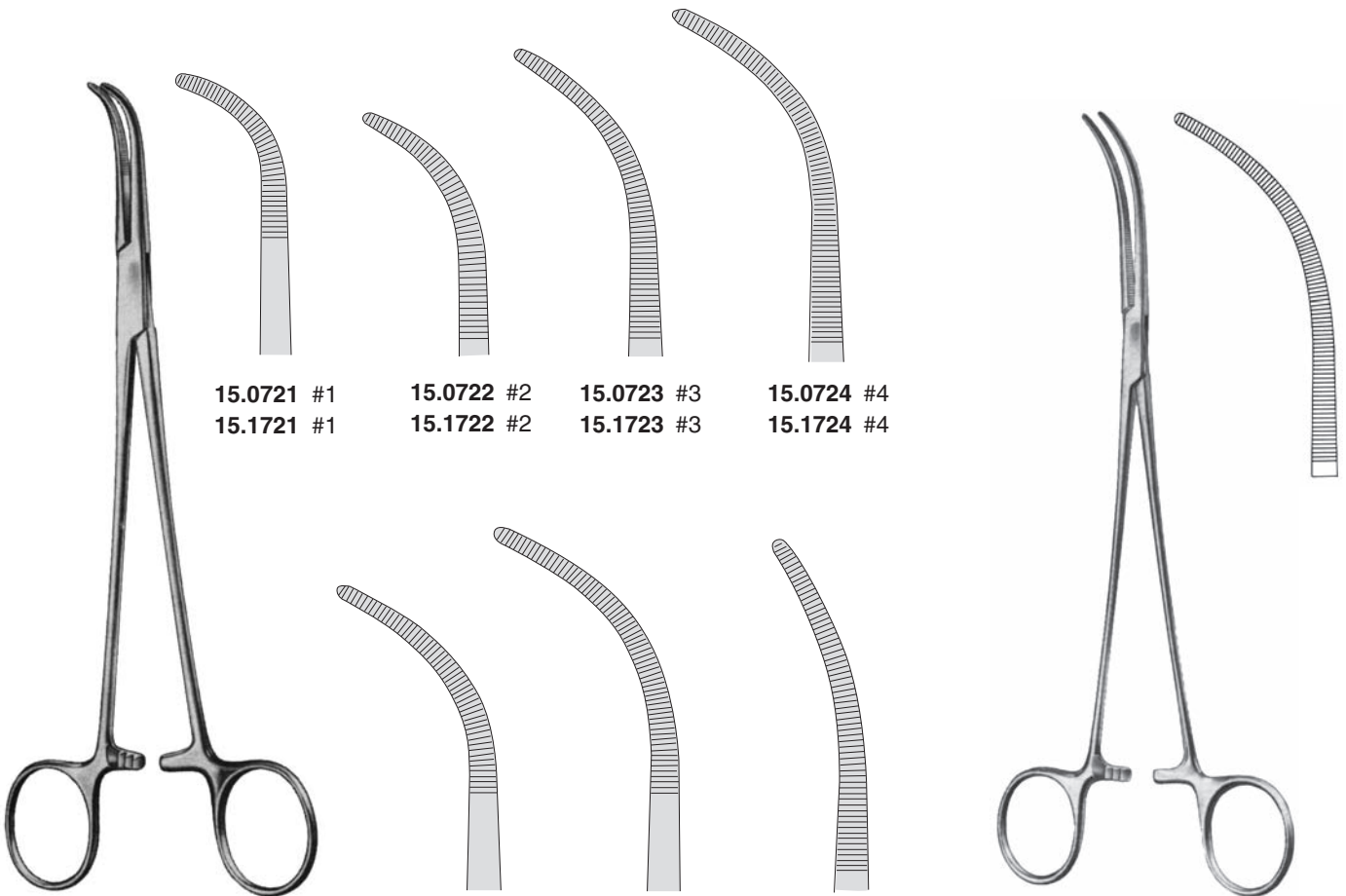

15.0721 #1
 15.1721 #1

15.0722 #2
 15.1722 #2

15.0723 #3
 15.1723 #3

15.0724 #4
 15.1724 #4

15.0725 #5
 15.1725 #5

15.0726 #6
 15.1726 #6

15.0727 #7
 15.1727 #7

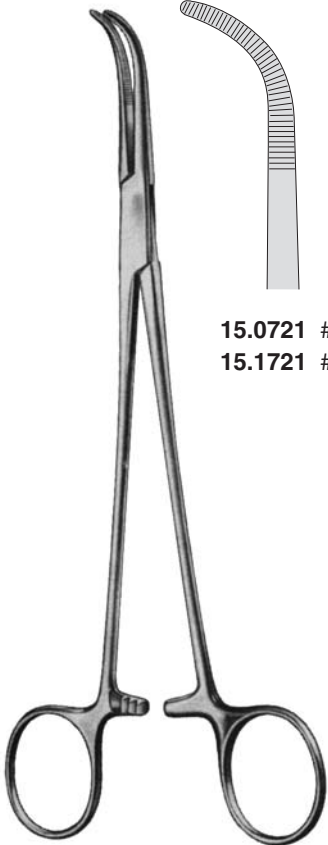

OVERHOLT-GEISSENDOERFER
 15.0721-15.0727 21 cm
 15.1721-15.1727 27 cm



OVERHOLT-MIXTER
 15.0729 21 cm

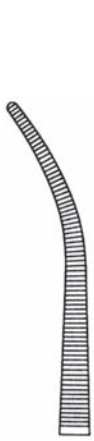

15.0531
19 cm



15.0532
22 cm



15.0533
24 cm



15.0534
19 cm



15.0535
22 cm

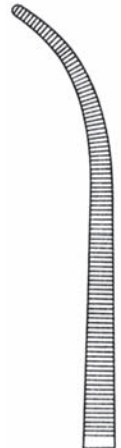

15.0536
24 cm

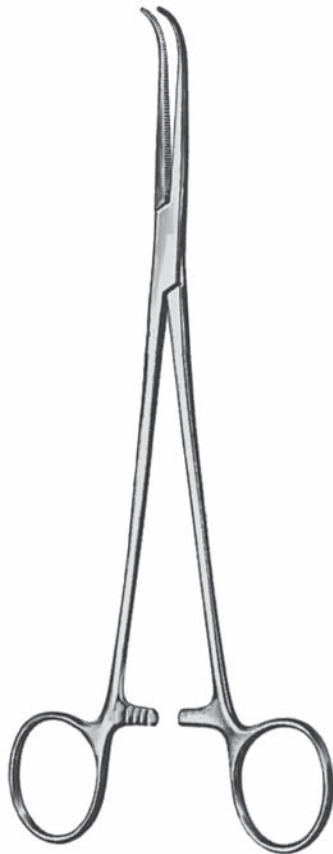

KELLY



15.0537
19 cm



15.0538
22 cm

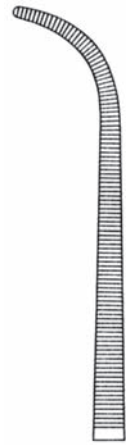

15.0539
24 cm

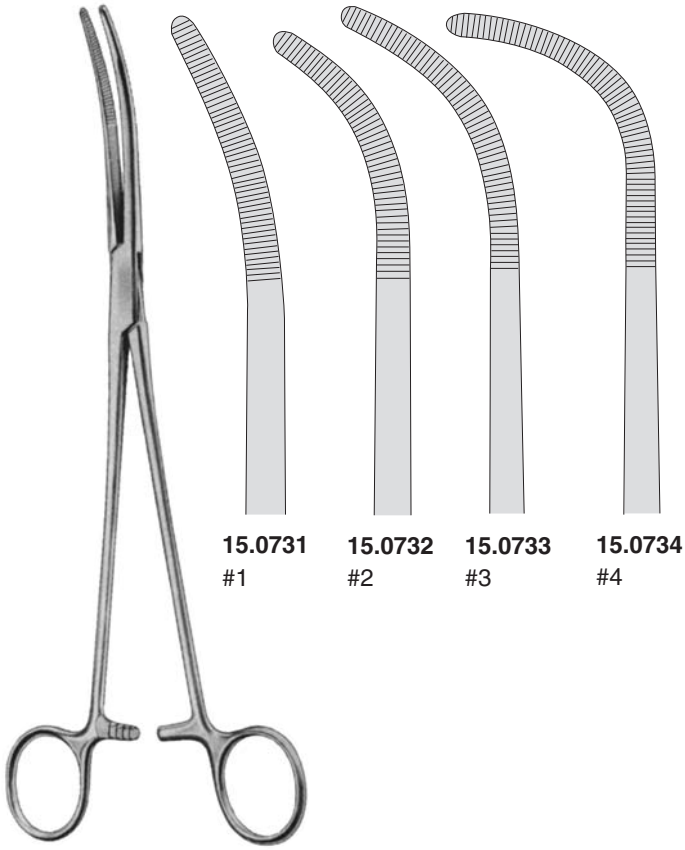

RUMEL
23 cm



KANTROWITZ

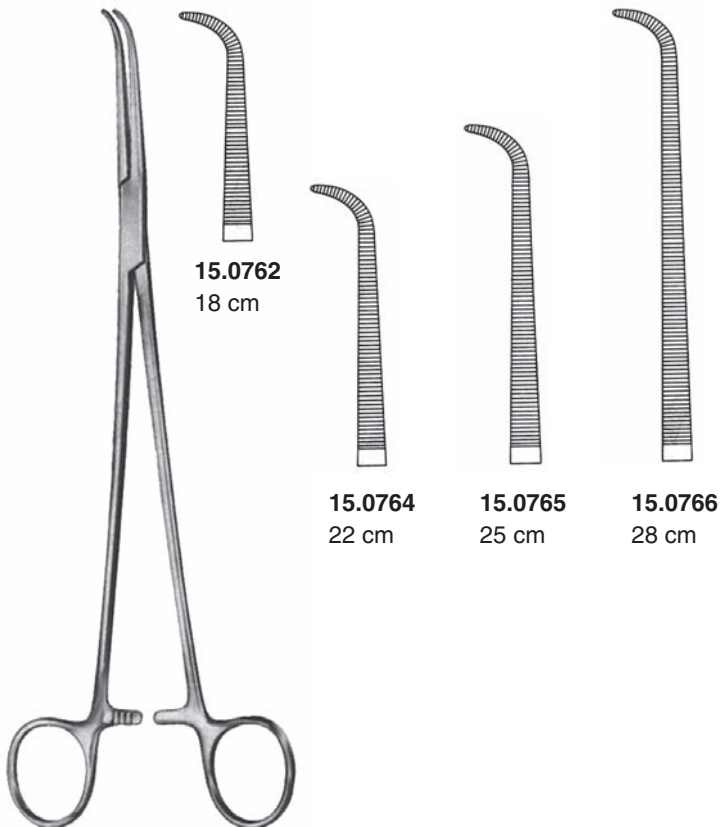

GEMINI-MINI

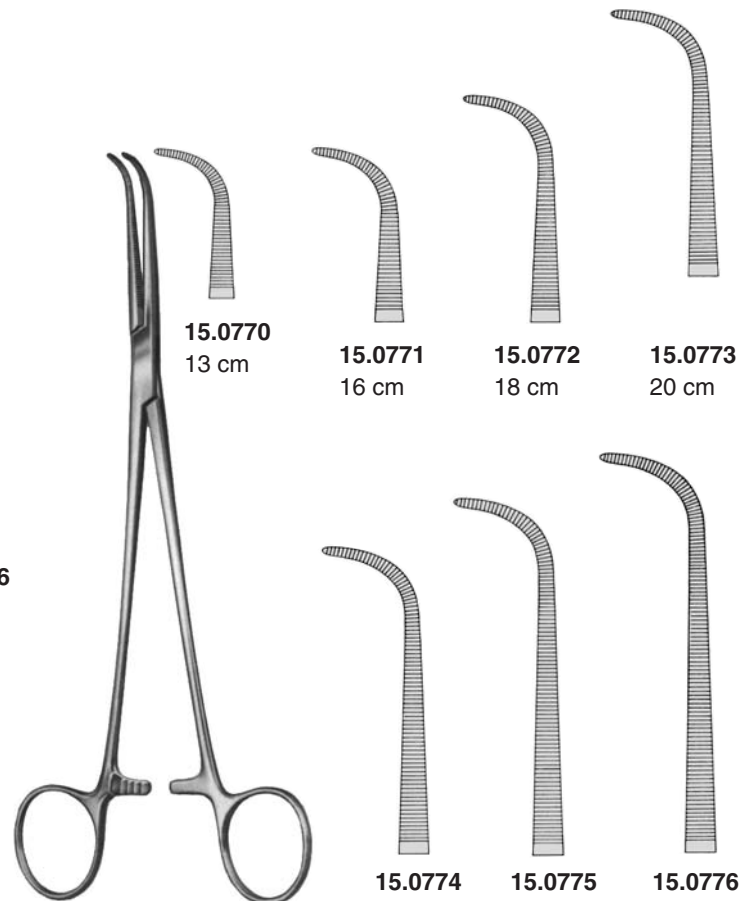

GEMINI



WIKSTROEM
15.0780 21 cm
15.0782 24 cm



MEEKER
15.0786 28 cm



MIXTER-BABY
15.0801 14,5 cm



MIXTER-BABY
15.0803 18 cm

15.0802

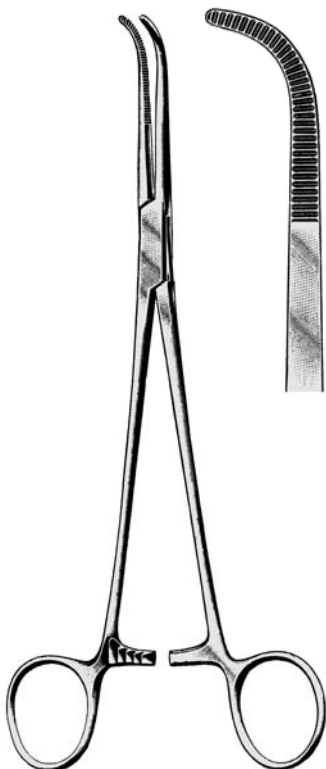

MIXTER
15.0807 22 cm



MIXTER

15.0811 16 cm
15.0813 19 cm
15.0817 23 cm



MIXTER
15.0831 22 cm

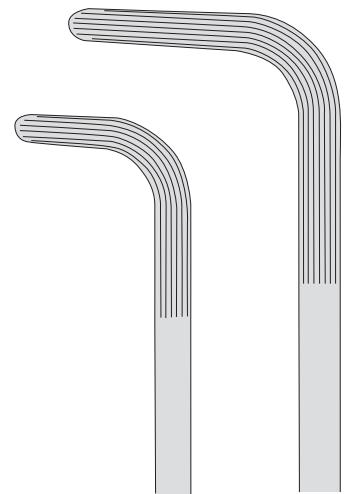

15.0833
25 cm

15.0835
28 cm

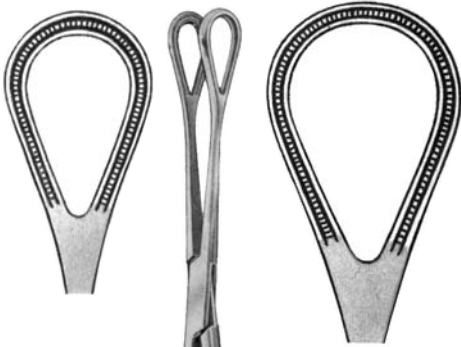

15.1580

15.1582

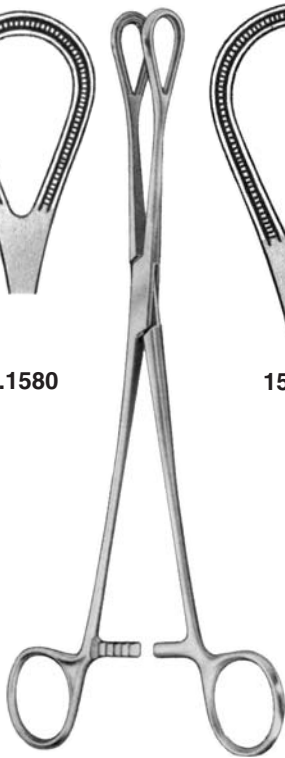

DEBAKEY
25 cm

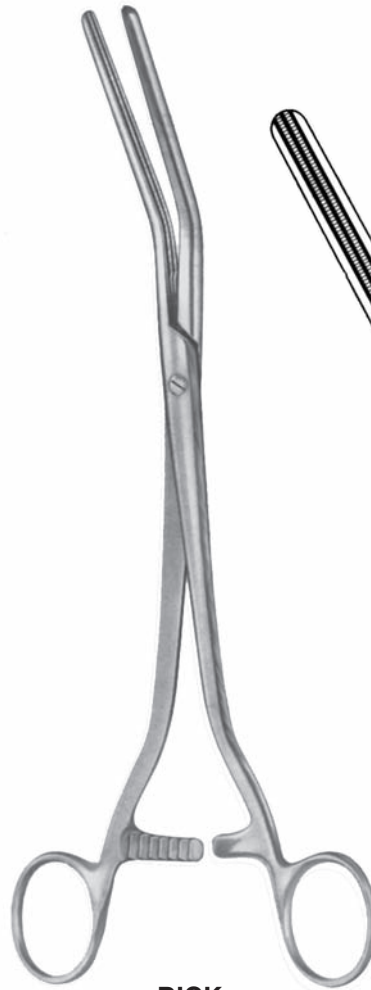

DICK

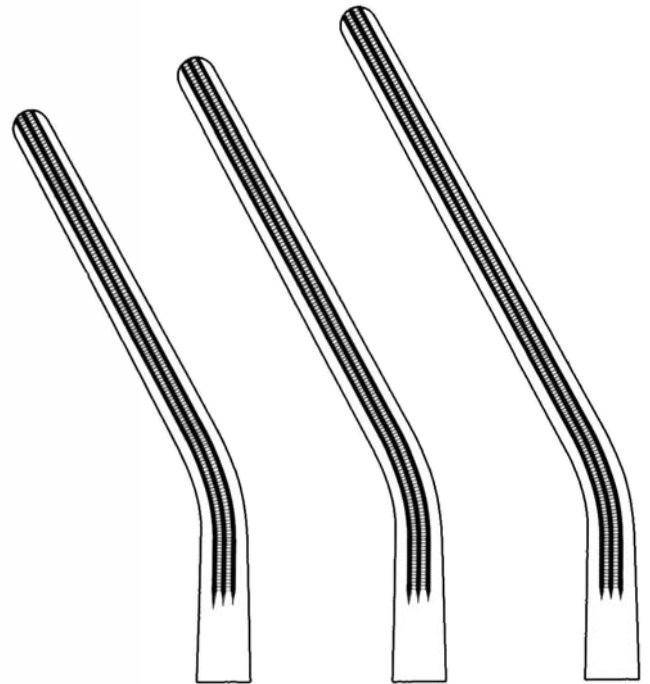

15.2230
25 cm

15.2232
26 cm

15.2234
27 cm

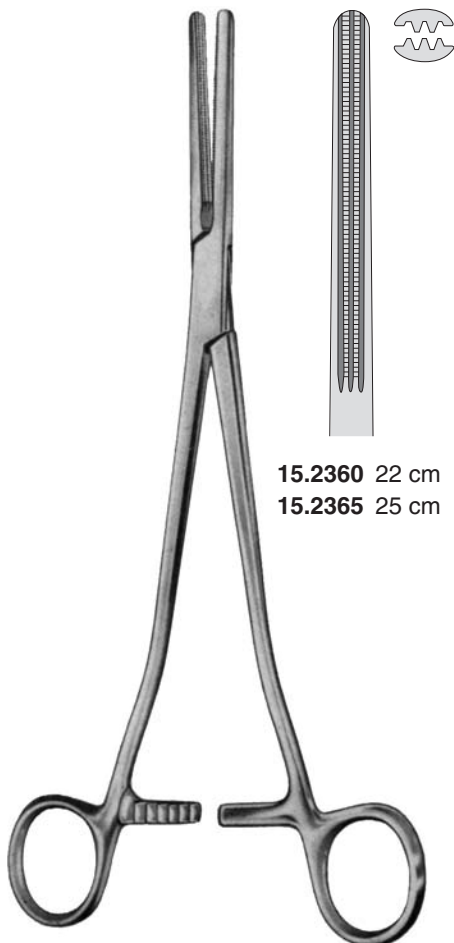

WERTHEIM-DEBAKEY

15.2360 22 cm
15.2365 25 cm



15.2361 22 cm
15.2366 25 cm

15.2362 21 cm
15.2367 25 cm

15.2363 20 cm
15.2368 24 cm



ALLIS-BABY

48.0004 13 cm, 4 x 5
 48.0006 14 cm, 4 x 5



ALLIS



48.0010
 15 cm, 4 x 5



48.0011
 15 cm, 5 x 6
48.0014
 19 cm, 5 x 6
48.0016
 23 cm, 5 x 6



ALLIS



48.0020
 16 cm



48.0024
 20 cm



48.0028
 25 cm

atraumatisch
 atraumatic
 atraumatique
 atraumática



ALLIS-ADAIR

48.0030 15,5 cm



JUDD-ALLIS
 48.0032 15 cm
 48.0034 19 cm
 3 x 4



BOYS-ALLIS
 48.0036 15 cm



THOMS-ALLIS
 48.0038 20 cm
 6 x 7

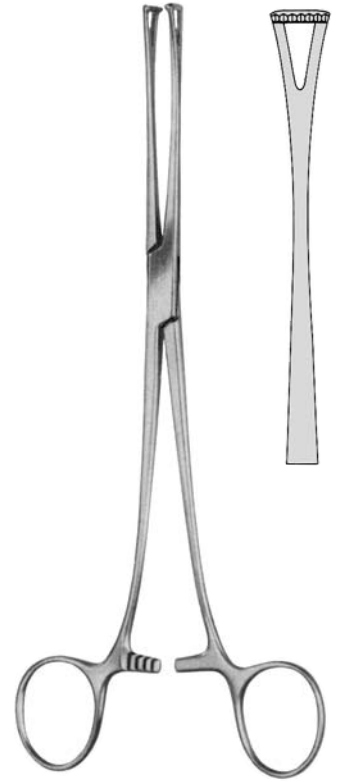

LOCKWOOD
 48.0040 19,5 cm



WILLIAMS
 48.0045 16,5 cm



BABCOCK



48.0062
 16 cm



48.0064
 18 cm

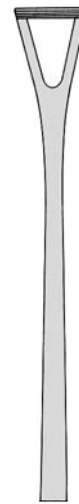

48.0066
 20 cm

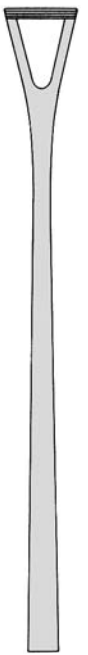

48.0068
 24 cm



BABCOCK

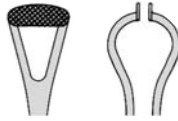

48.0072
16 cm

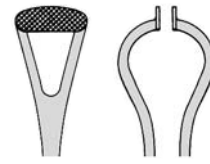

48.0076
20 cm

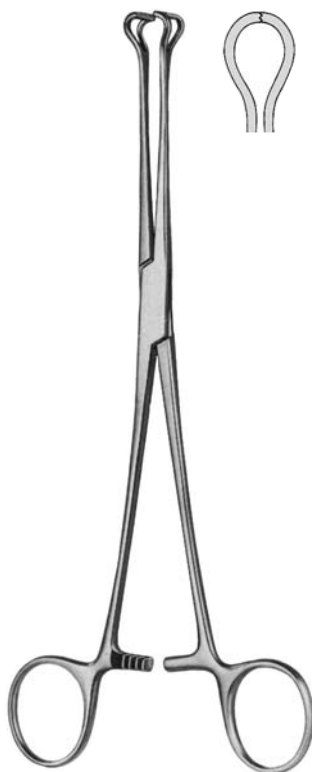

BABCOCK-DEBAKEY



48.0082
16 cm

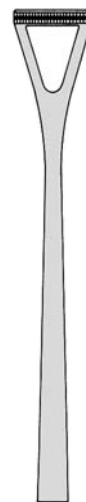

48.0086
20 cm

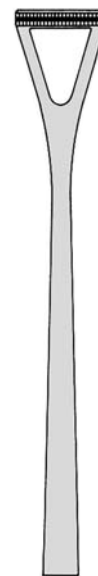

48.0088
23 cm



COLLIN
 48.0089
 14 cm



DUVAL



48.0090
 18 cm / 14 mm
48.0092
 20 cm / 14 mm

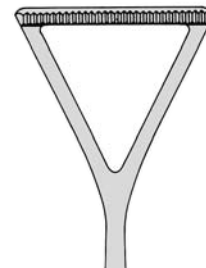

48.0094
 20 cm / 25 mm
48.0098
 23 cm / 25 mm



48.0094 AT
 20 cm / 20 mm
48.0098 AT
 23 cm / 25 mm
 atraumatisch
 atraumatic
 atraumatique
 atraumática

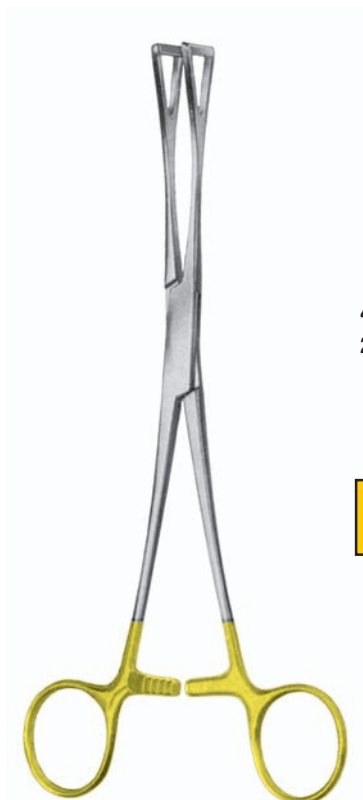

48.0099
 20 cm / 15 mm



DUVAL

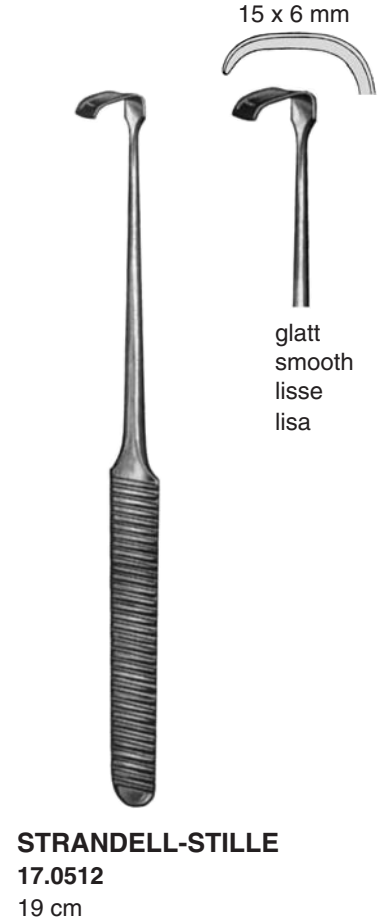
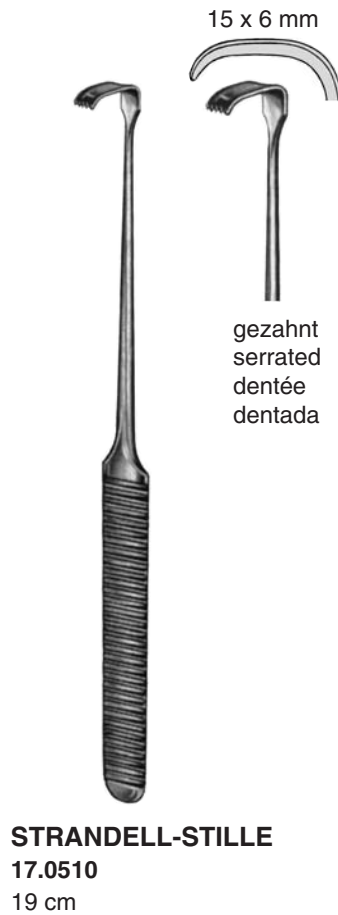
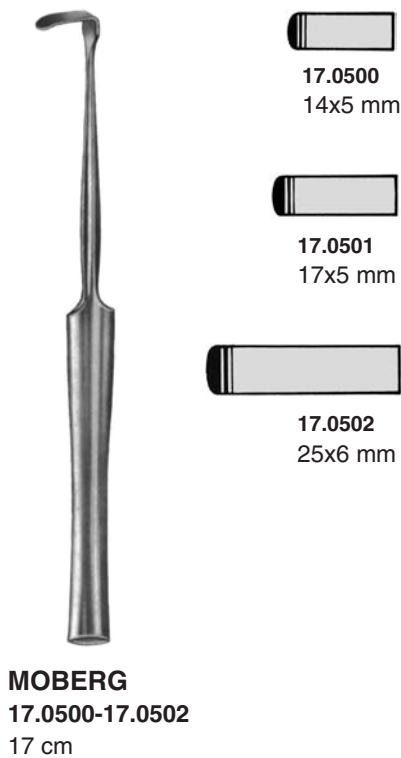
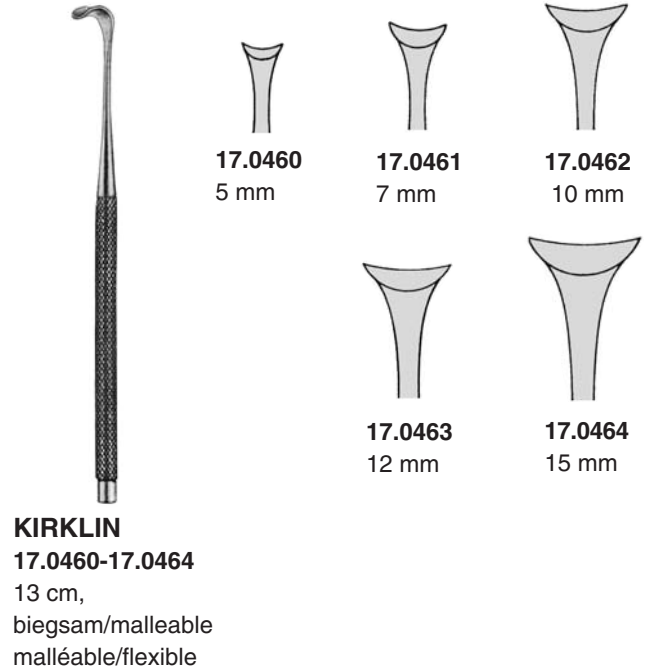
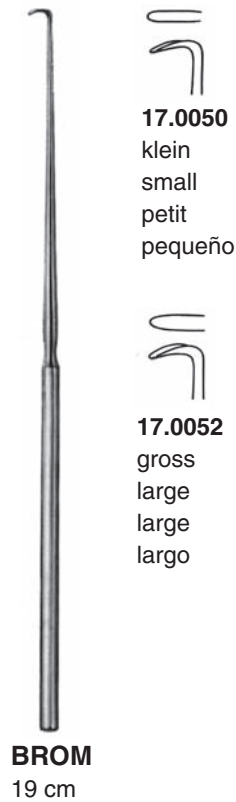
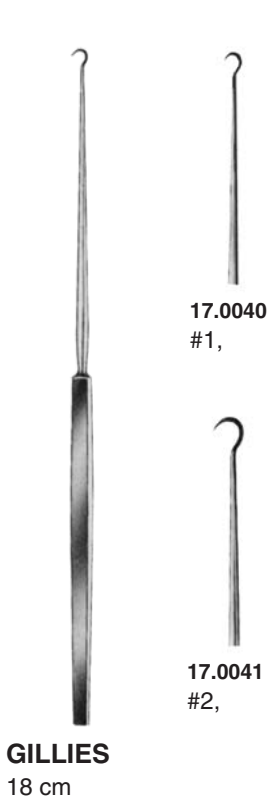

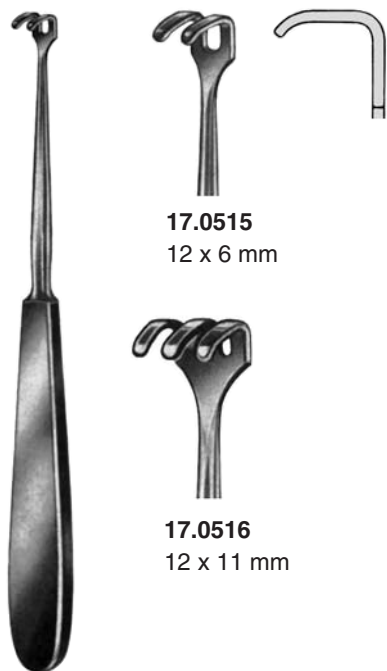

17.0515
12 x 6 mm



17.0516
12 x 11 mm

KLAPP
17,5 cm



17.0520
13 x 13 cm



17.0522
12 x 16 cm

KÖNIG
17.0520-17.0522
18 cm



17.0570
11 x 14 mm



17.0571
13 x 17 mm

CUSHING
20 cm



CUSHING
17.0575
21 cm 10 x 11 mm



17.0577
14 x 11 mm



17.0578
18 x 13 mm



17.0579
22 x 15 mm

CUSHING
25 cm



RAGNELL-DAVIS
17.0585 14 cm

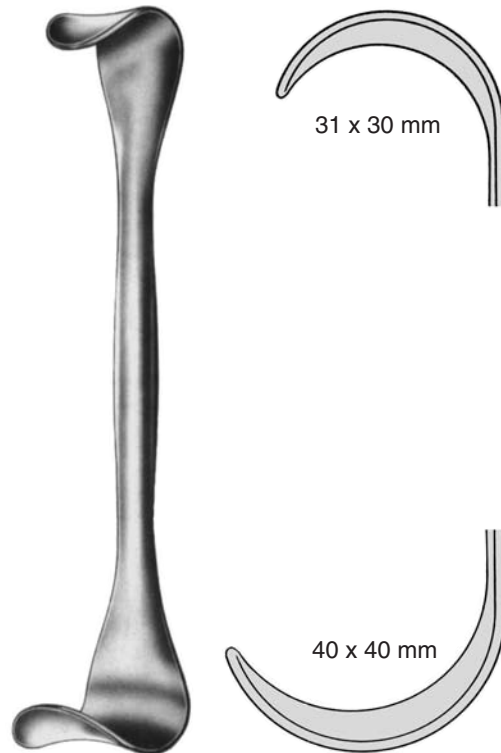

GOELET
17.0670 19 cm



GIL-VERNET
24 cm
biegsam/malleable
malléable/flexible



17.0680 9 mm



17.0683 15 mm



17.0681 11 mm



17.0684 18 mm



17.0682 13 mm



MORSE
23 cm



17.0690
10 mm



17.0691
15 mm



17.0692
20 mm



17.0693
30 mm



17.0694
40 mm



17.0695
50 mm



KOCHER
19 cm
17.1070 19 x 12 mm
17.1071 21 x 14 mm



KOCHER
22 cm
17.1072 40 x 10 mm
17.1073 40 x 15 mm
17.1074 40 x 20 mm



WASSMUND
20 cm
17.0900
33 x 20 mm



KOCHER
23 cm
17.1075 70 x 25 mm



KOCHER
25 cm
17.1076 80 x 45 mm
17.1077 80 x 55 mm
17.1078 80 x 65 mm



MIDDELDORPF
22 cm
17.1080 16 x 17 mm
17.1081 20 x 22 mm
17.1082 26 x 30 mm



MIDDELDORPF

26 cm

17.1083 45 x 45 mm

17.1084 45 x 50 mm

17.1085 55 x 70 mm



MIDDELDORPF

23 cm

17.1086 20 x 22 mm

17.1087 26 x 30 mm



GREEN

22 cm

17.1088 12 x 25 mm



ZENKER

26 cm

17.1196 35 x 8 mm

17.1197 60 x 12 mm

17.1198 75 x 12 mm

17.1199 85 x 12 mm

17.1200 120 x 12 mm



KADER

27 cm
17.1232 20 mm
17.1233 30 mm
17.1234 40 mm



TUFFIER

17.1240 20 cm

25 / 17 mm

biegsam
malleable
malléable
maleable

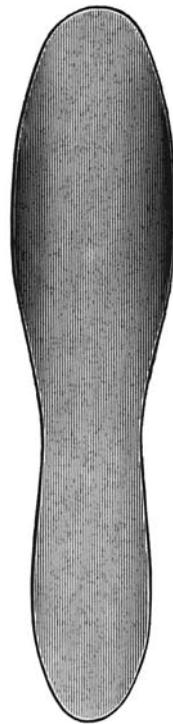

REVERDIN

17.1250 29 cm
45 / 60 mm



REVERDIN

17.1251 28 cm
45 / 60 mm



HABERER

17.1255 30 cm 37/45 mm
17.1256 28 cm 25/30 mm
17.1257 20 cm 17/25 mm

biegsam
malleable
malléable
maleable

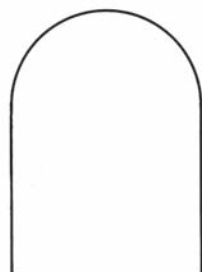

17.1274C
330 x 25 mm

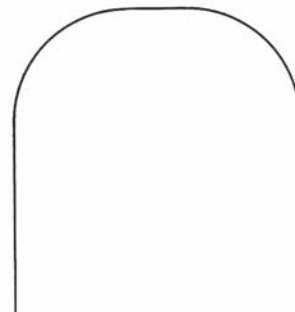

17.1276C
330 x 38 mm

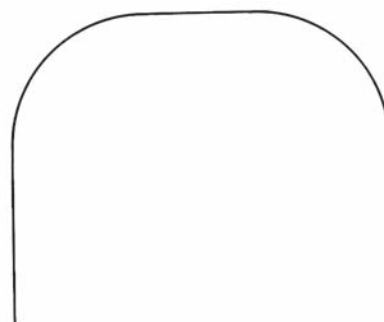

17.1277C
330 x 50 mm

DEAVER
17.1274C-17.1279C

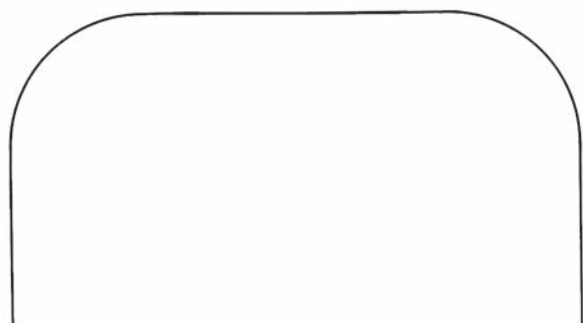

17.1278C
330 x 75 mm

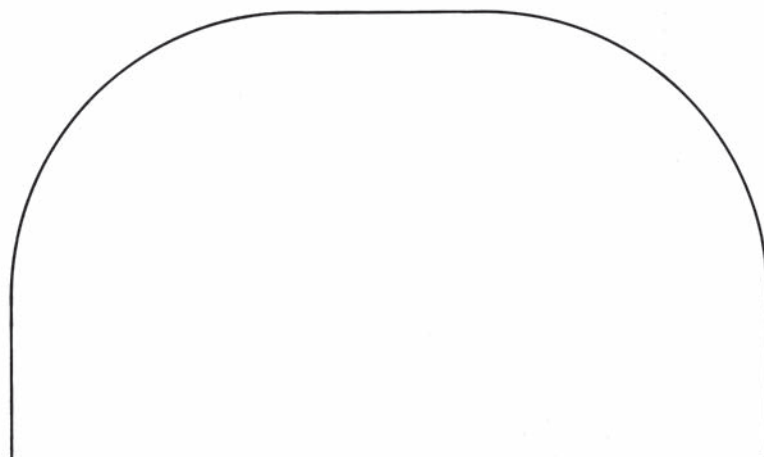

17.1279C
330 x 100 mm

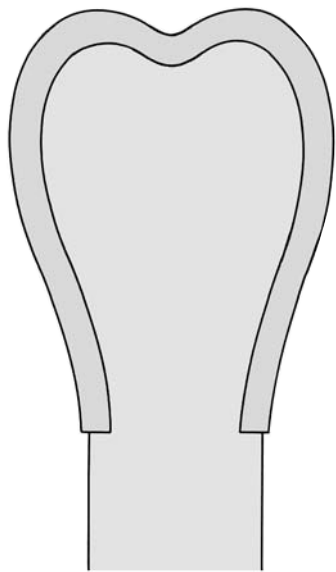

HARRINGTON

32 cm

17.1290 127 x 25 mm

17.1291 127 x 40 mm

17.1292 127 x 62 mm



ALLISON
17.1302 26 cm / 40 mm



ALLISON
17.1304 30 cm / 45 mm
17.1306 32 cm / 57 mm



ALLISON
17.1310 26 cm / 132 mm



DAVIDSON
17.1320 75 x 50 mm



DAVIDSON
17.1322 75 x 90 mm



POLLOSON
17.1400
27 cm



POLLOSON

17.1410

27 cm

gefenstert

fenestrated

a jouré

fenestrada



ROSS
40.0391-40.0396
27 cm



40.0391
Fig. 1



40.0392
Fig. 2



40.0393
Fig. 3



40.0394
Fig. 4



40.0395
Fig. 5



40.0396
Fig. 6

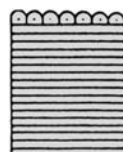

40.0400
15 x 15 mm

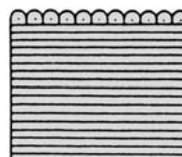

40.0402
15 x 23 mm

CRAWFORD
19 cm



rechts
right
à droite
a derecha

COOLEY
40.0410
21,5 cm



rechts
right
à droite
a derecha

gezahnt
serrated
dentées
dentadas

COOLEY
40.0411
21,5 cm



links
left
à gauche
a izquierda

COOLEY
40.0412
23 cm



links
left
à gauche
a izquierda

gezahnt
serrated
dentées
dentadas

COOLEY
40.0413
23 cm

Atriumhaken / Atrium Retractors / Ecarteurs pour auricules cardiaques / Separadores para auricula



17.5010
7 cm



17.5011
7 cm



ALM

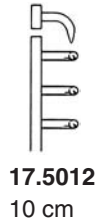

17.5012
10 cm

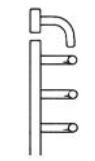

17.5013
10 cm



ALLPORT

17.5150 10 cm

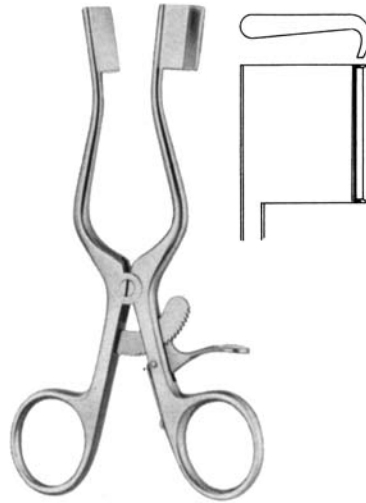

WEITLANER-BABY

17.5290 14 cm

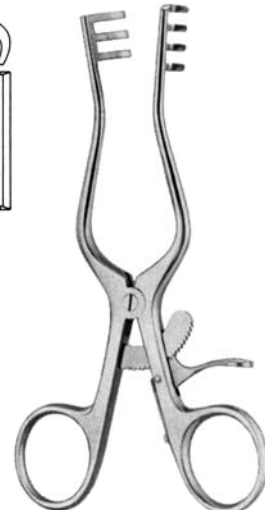

WEITLANER

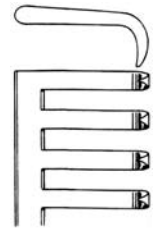

17.5302 13 cm
17.5304 16,5 cm

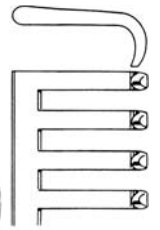

17.5303 13 cm
17.5305 16,5 cm



WEITLANER

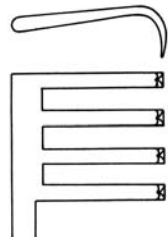

17.5306 20 cm

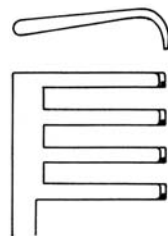

17.5307 20 cm



17.5308 24 cm



17.5309 24 cm

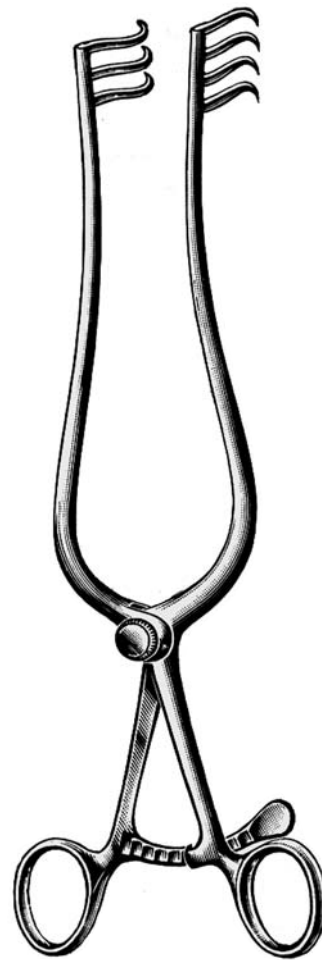

WEITLANER

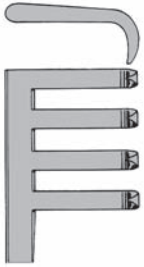

17.5600
14 cm

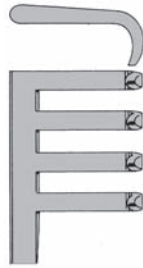

17.5601
14 cm



17.5602
16,5 cm

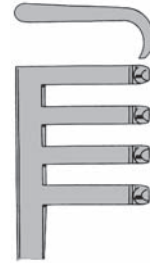

17.5603
16,5 cm



BECKMANN-WEITLANER

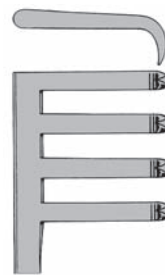

17.5604
20 cm

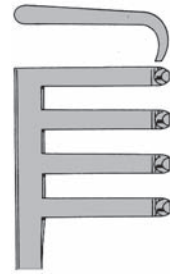

17.5605
20 cm

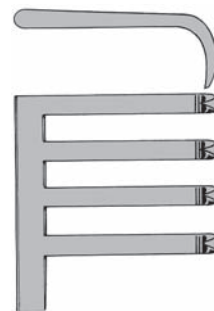

17.5606
26 cm

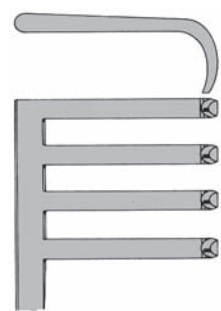

17.5607
26 cm



KILNER
13 cm

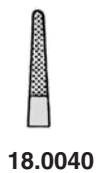

18.0040

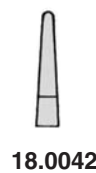

18.0042
glatt
smooth
lisse
lisa

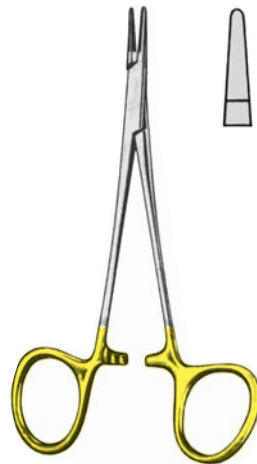

NEIVERT
18.0050 12 cm



BABY-CRILE-WOOD
18.0069 15 cm

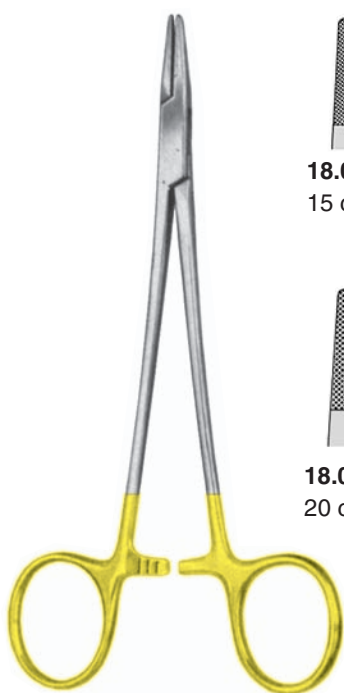

CRILE-WOOD



18.0070
15 cm



18.0072
18 cm



18.0074
20 cm



18.0076
23 cm

18.0079
15 cm
für Linkshänder
for left hand
pour gaucher
para zurdo

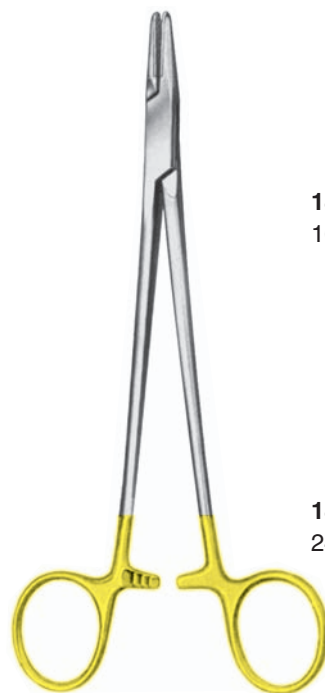

MAYO-HEGAR



18.0080
16 cm



18.0082
18 cm

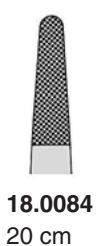

18.0084
20 cm



18.0086
24 cm



18.0088
26 cm



18.0090
30 cm

18.0091
37 cm

PROME(DUR)



DEBAKEY



18.0100
18 cm



18.0102
20 cm



18.0104
23 cm



18.0106
26 cm



18.0108
31 cm



18.0110
37 cm



JULIAN



18.0113
20 cm

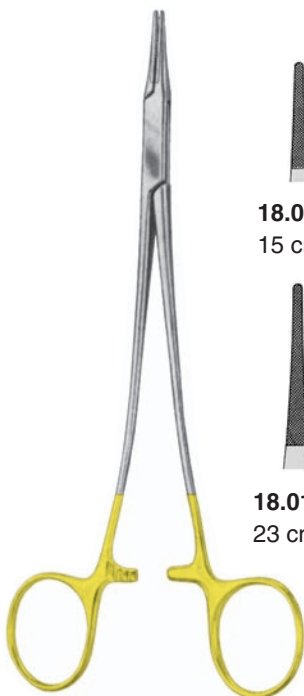

MICRO-VASCULAR



18.0130
15 cm



18.0136
23 cm



18.0132
18 cm



18.0138
25 cm



18.0134
20 cm



BERRY STERNAL



18.0140
18 cm



FINOCHIETTO



18.0150
21 cm
18.0152
27 cm



18.0160
20 cm



18.0162
24 cm



18.0164
26 cm



18.0166
30 cm



MASSON
18.0170 27 cm



WANGENSTEEN
18.0180 28 cm



PROME(DUR)



HEANEY



18.0190
20 cm



18.0192
24 cm



18.0194
26 cm



STRATTE



18.0202
21 cm



18.0204
23 cm

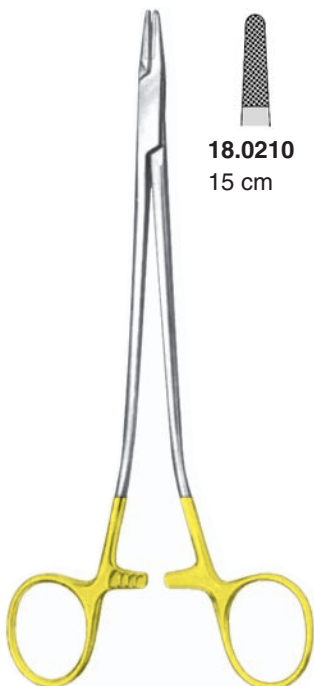

SAROT



18.0210
15 cm



18.0212
18 cm



18.0214
27 cm



LANGENBECK



18.0242
18 cm



18.0244
20 cm



18.0246
23 cm



MATHIEU

18.0250
14 cm

18.0252
17 cm

18.0254
20 cm

18.0256
24 cm



MATHIEU

18.0260
14 cm

18.0262
17 cm

18.0264
20 cm

18.0266
23 cm



MATHIEU-KOCHER

18.0270
14 cm

18.0272
17 cm

18.0274
20 cm



LICHTENBERG

18.0280
20 cm



18.0322
16 cm

GILLIES



18.0330
12 cm

OLSEN-HEGAR



18.0331
12 cm
glatt
smooth
lisse
lisa



18.0332
14 cm

OLSEN-HEGAR



18.0334
16,5 cm

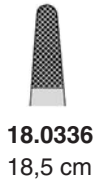

18.0336
18,5 cm



RYDER



18.0530
13 cm



18.0532
15 cm



18.0534
18 cm



18.0536
20 cm



18.0538
23 cm



18.0540
26 cm



RYDER-MINI



18.0550
13 cm



18.0552
15 cm



18.0554
18 cm



18.0556
20 cm



18.0558
23 cm





18.0560
25 cm



-  **18.0600** 18 cm
- 18.0602** 20 cm
- 18.0604** 23 cm
- 18.0606** 26 cm

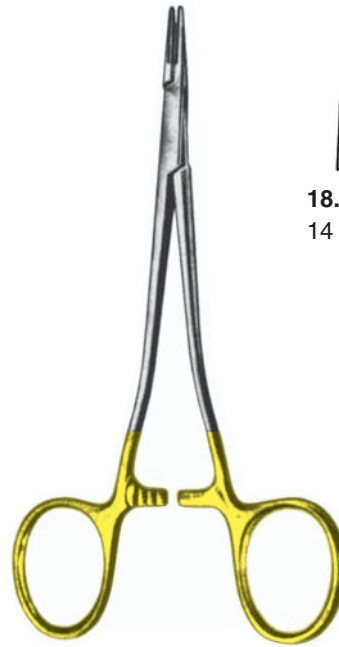

DIETHRICH





-  **18.0610**
14 cm
-  **18.0612**
20 cm

INTRACARDIAC



-  **18.0800** 14 cm
 - 18.0802** 18 cm
 - 18.0804** 21 cm
 -  **18.0801**
 - 18.0803**
 - 18.0805**
- glatt/smooth/ lisses/ lisas

-  **18.0810** 14 cm
- 18.0812** 18 cm
- 18.0814** 21 cm
-  **18.0811**
- 18.0813**
- 18.0815**

CASTROVIEJO



CASTROVIEJO
18.0840 13 cm

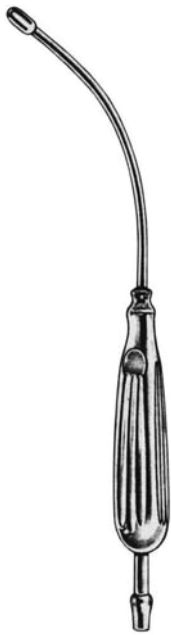

ANDREW-PYNCHON
19.0700 24 cm

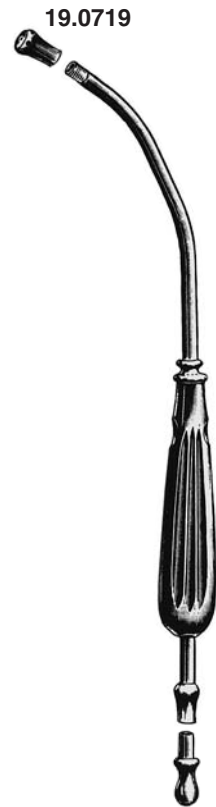

YANKAUER
19.0710 27 cm
komplett
complete
complet
completo

19.0718



POOLE
19.0720 30 Fr.



POOLE
19.0721 20 cm / 23 Fr.
19.0727 20 cm/ 18 Fr.

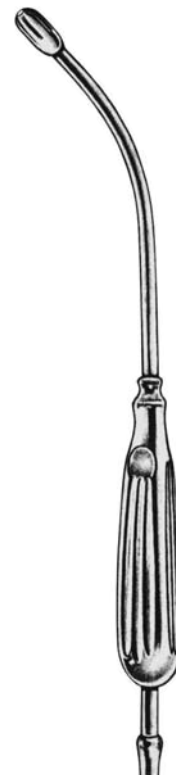

DEBAKEY
19.0746 31 cm / 9 mm

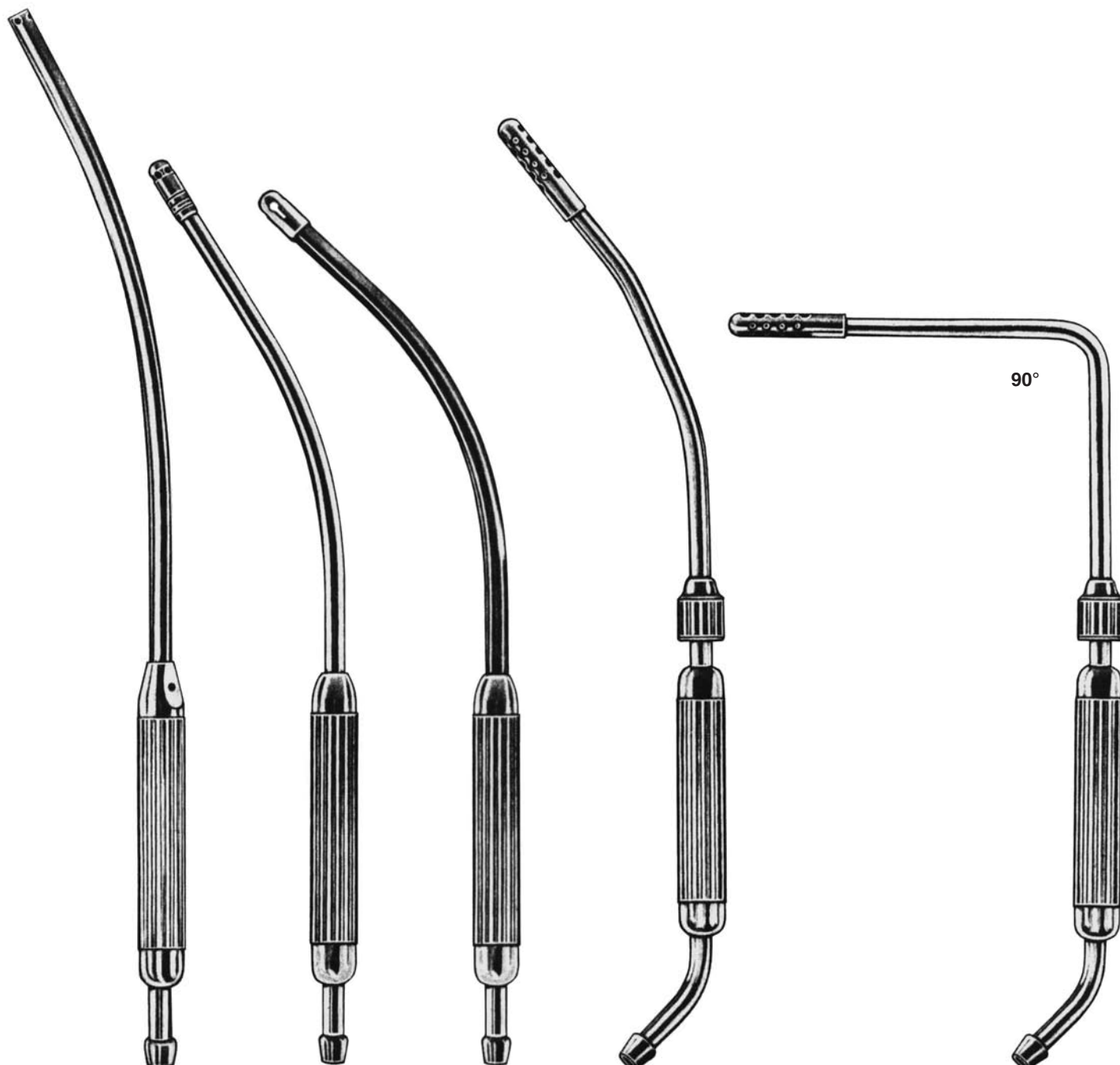

COOLEY
19.0750
35 cm #1

COOLEY
19.0751
31 cm #2

COOLEY
19.0752
30 cm #3

COOLEY
19.0753
33 cm #4

COOLEY
19.0754
26 cm #5



FÜHRUNGSNADEL

20 cm

19.0760 8 Charr

19.0761 10 Charr

19.0762 12 Charr

19.0763 14 Charr

19.0764 16 Charr

19.0765 18 Charr



FÜHRUNGSNADEL

20 cm

19.0770 8 Charr

19.0771 10 Charr

19.0772 12 Charr

19.0773 14 Charr

19.0774 16 Charr

19.0775 18 Charr

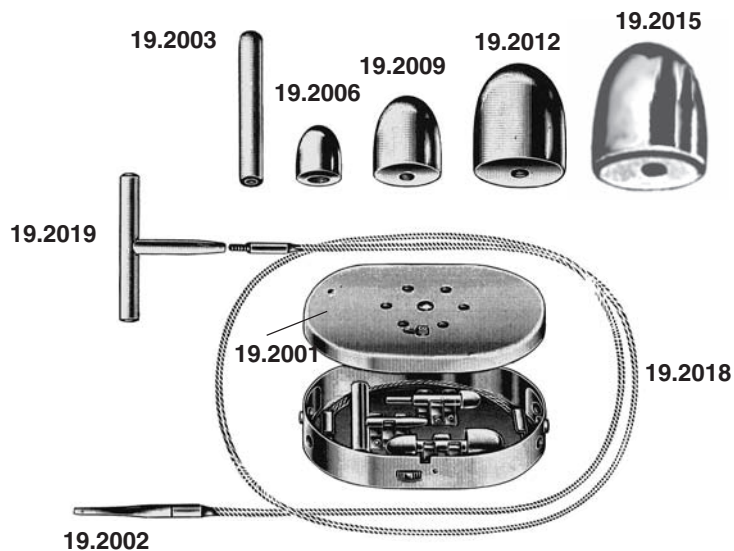

NABATOFF

19.2000

Krampfader-Besteck
 Varicose vein probe set
 Trousse à varices
 Astuche para varices

19.2000	Krampfader-Besteck in Metalltui bestehend aus:	Varicose vein probe set in metal case, consisting of:	Trousse à varices composé de:	Astuche para varices compuesto de:
19.2001	Metalltui alleine	Metal case only	Boîte métal	Estuche de metal
19.2002	Kunststoff-Sondenspitze	Plastic probe	Pointe plastique	Punta de materia plástica
19.2003	Sondenspitze 3 mm Ø	Probe Tip 3 mm Ø	Pointe métallique 3 mm Ø	Punta de sonda 3 mm Ø
19.2006	Olive 6 mm Ø	Olive 6 mm Ø	Olive métallique 6 mm Ø	Oliva 6 mm Ø
19.2009	Olive 9 mm Ø	Olive 9 mm Ø	Olive métallique 9 mm Ø	Oliva 9 mm Ø
19.2012	Olive 12 mm Ø	Olive 12 mm Ø	Olive métallique 12 mm Ø	Oliva 12 mm Ø
19.2015	Olive 15 mm Ø	Olive 15 mm Ø	Olive métallique 15 mm Ø	Oliva 15 mm Ø
19.2018	Zugseil 90 cm	Cable 90 cm	Cable tracteur, flexible 90 cm	Cable de tracción 90 cm
19.2019	Griff	Handle only	Manche	Mango suelto



ALDERDYCE
23.0036
21 cm



LANGENBECK



23.0050
20 cm / 7 mm



23.0052
20 cm / 10 mm

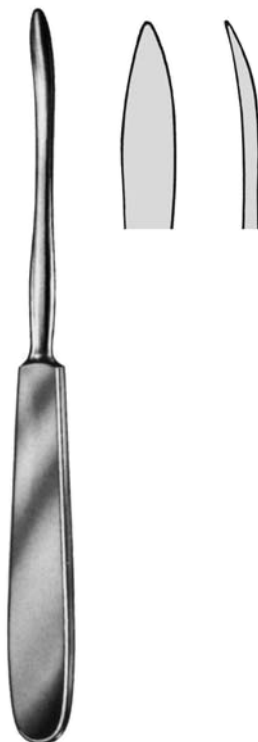

QUERVAIN
23.0060
20 cm / 6 mm



COBB

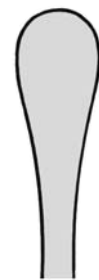

23.0080
28 cm / 10 mm

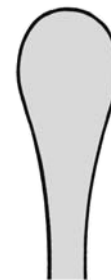

23.0081
28 cm / 13 mm

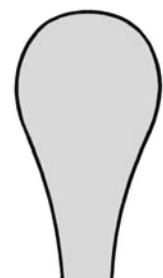

23.0082
28 cm / 19 mm



KEY
 23.0090 17 cm / 3 mm
 23.0091 17 cm / 6 mm
 23.0092 17 cm / 9 mm
 23.0093 17 cm / 12 mm
 23.0094 19 cm / 19 mm
 23.0095 19 cm / 25 mm

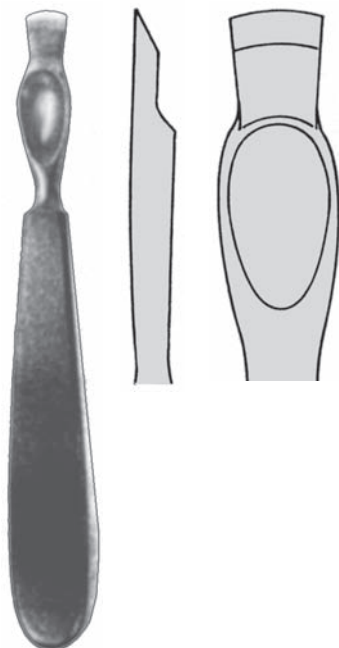

KIRMISSION
 23.0519 16,5 cm/ 15 mm

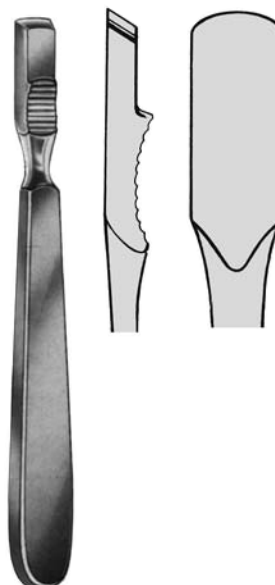

FARABEU
 23.0520 15 cm/ 13 mm



FARABEU
 23.0521 15 cm/ 13 mm

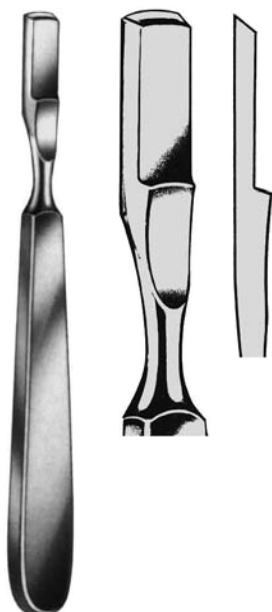

FARABEU-COLLIN
 23.0522 15,5 cm/ 11 mm

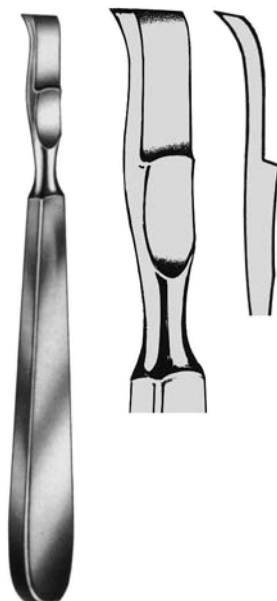

FARABEU-COLLIN
 23.0523 15,5 cm/ 11 mm

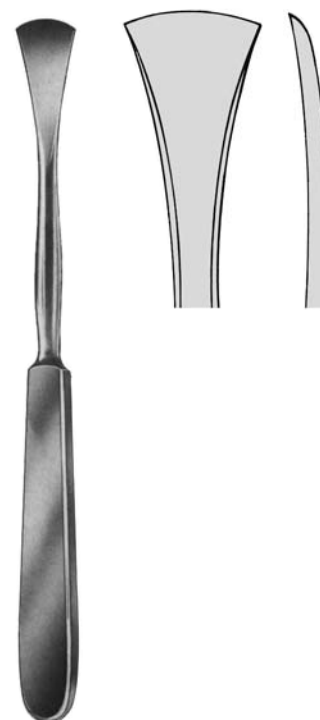

LANGENBECK
 23.0530 19 cm / 16 mm

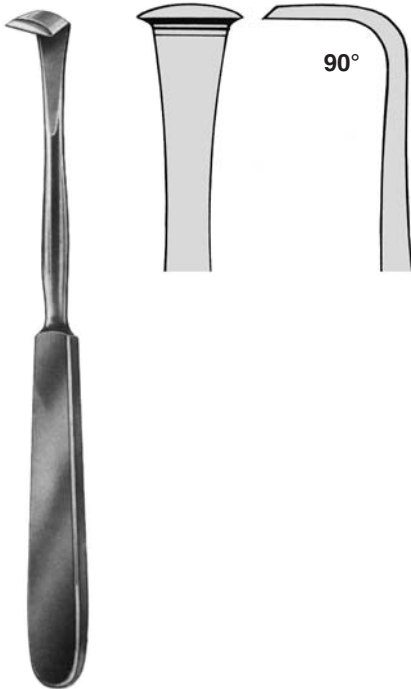

LANGENBECK
23.0531 19 cm

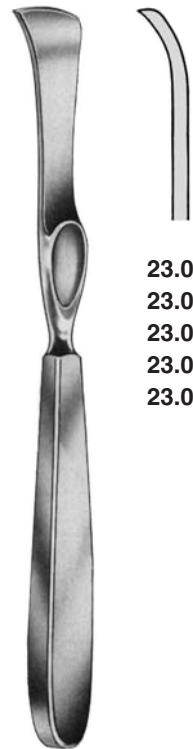

- 23.0540 5 mm
- 23.0542 10 mm
- 23.0544 15 mm
- 23.0546 20 mm
- 23.0548 25 mm

LAMBOTTE
21 cm

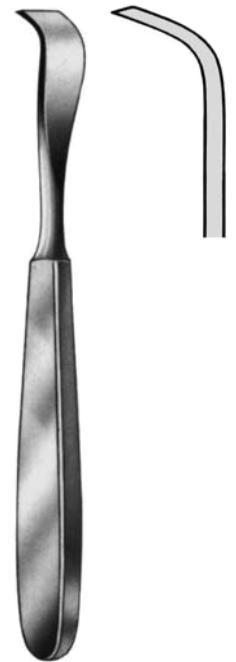

SCHNEIDER
23.0550 17,5 cm / 13 mm



SCHNEIDER-SAUERBRUCH
23.0552 19 cm / 14 mm

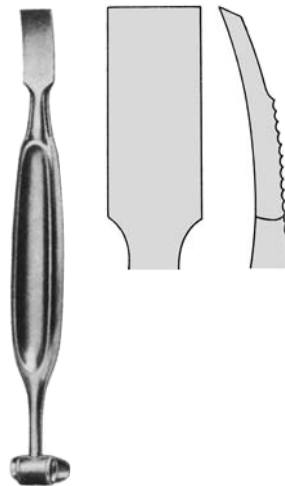

ALEXANDER
23.0560 21 cm

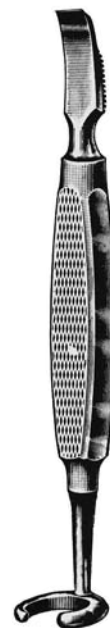

MATSON-ALEXANDER
23.0562 22 cm

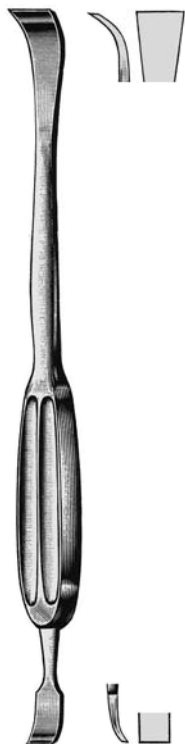

DAVIDSON-ALEXANDER
23.0565 29 cm

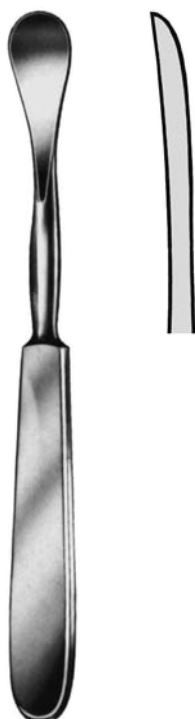

SEDILLOT
23.0570 18 cm / 18 mm



SEDILLOT
23.0575 21 cm / 15 mm

Kinder / Children / Enfants / Ninos



DOYEN
17 cm

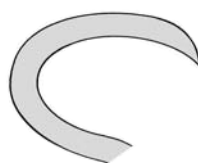

23.0580

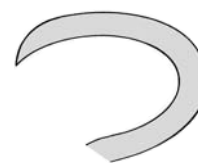

23.0581

Erwachsene / Adult / Adulte / Adultos

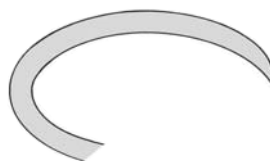

23.0582

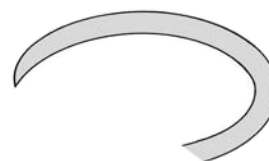

23.0583



MATSON
23.0590
22 cm

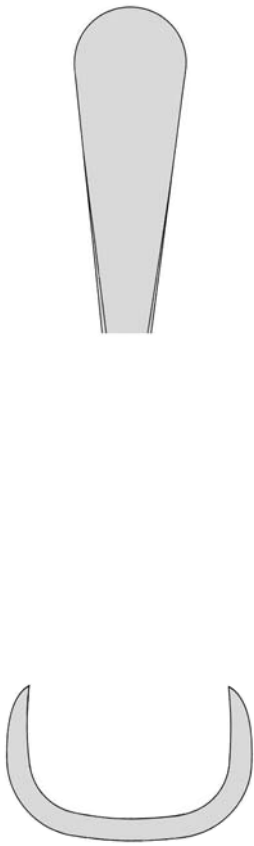

OVERHOLT
23.0592
28,5 cm #3

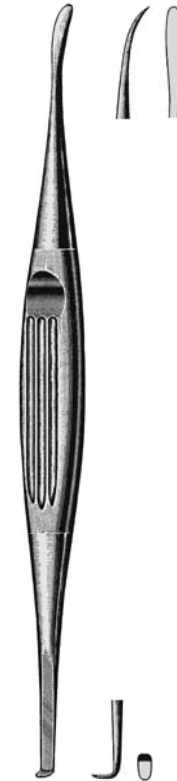

OVERHOLT
23.0593
29 cm #1

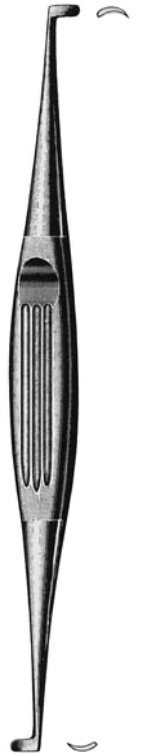

OVERHOLT
23.0594
28,5 cm #2



SEMB



23.0601
17,5 cm
#1



23.0602
21 cm
#2



23.0603
17,5 cm
#3



23.0604
21 cm
#4



23.0605
20,5 cm
#5



23.0606
20,5 cm
#6

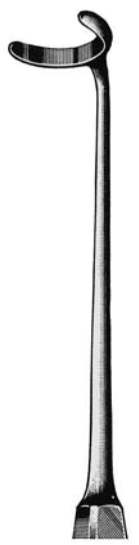

23.0607
22,5 cm
#7

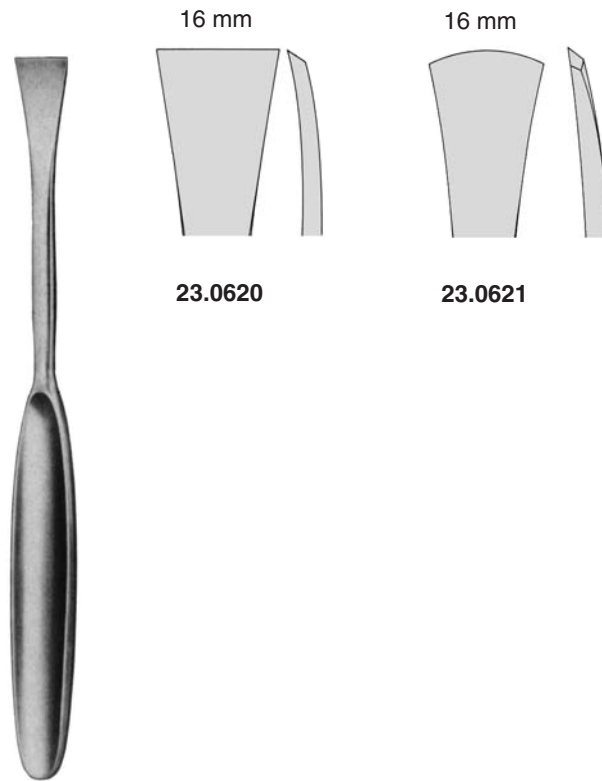

CUSHING
19 cm

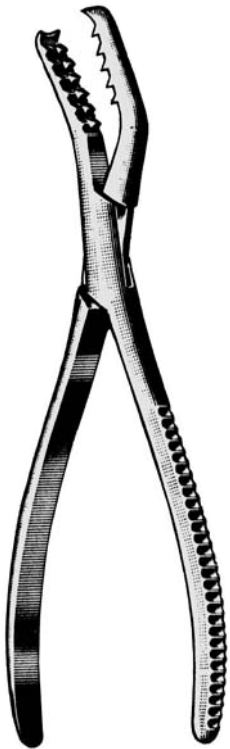

SEMB
23.2210 19 cm

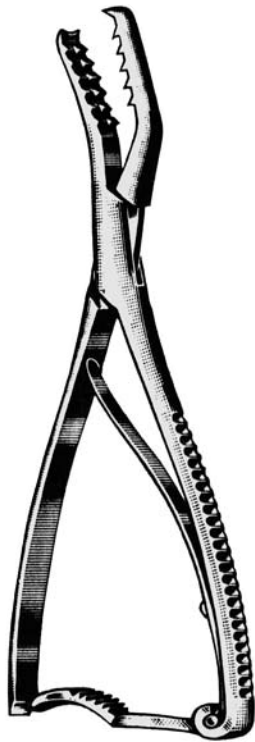

SEMB
23.2211 19 cm

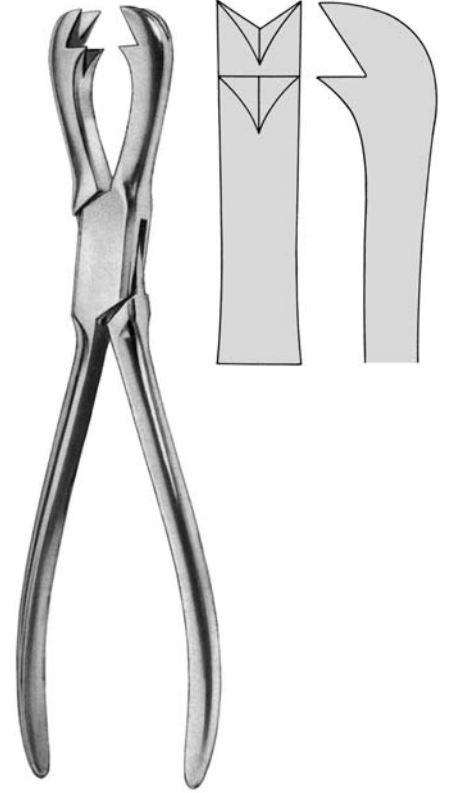

FERGUSSON
23.2220 21 cm



FARABEUF
23.2232 23 cm
23.2234 26 cm

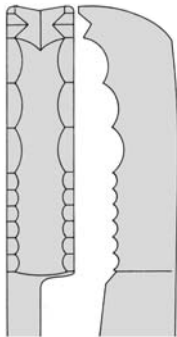

FARABEUF-LAMBOTTE
23.2235 26 cm

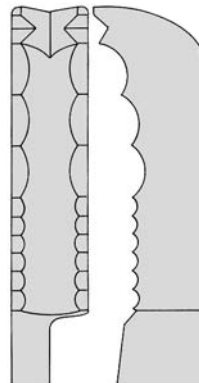

LANGENBECK
23.2240 20 cm





ULRICH



23.2302 23 cm

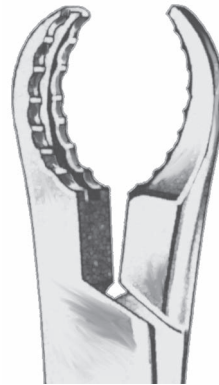

23.2304 25 cm



23.2306 28 cm



ULRICH



23.2305 25 cm



23.2307 28 cm



BEYER
23.2831 18 cm



ZAUFAL-JANSEN
23.2833 18 cm



MAYFIELD
23.2835 18,5 cm



MARQUARDT
23.2837 20 cm



RUSKIN
18 cm

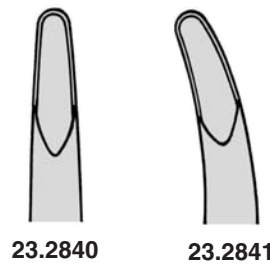

RUSKIN
23.2849 24 cm



STILLE-RUSKIN
23.2851 24 cm



SMITH-PETERSEN
24 cm



STILLE-LUER
22 cm



STILLE
23.2890 23 cm / 6mm

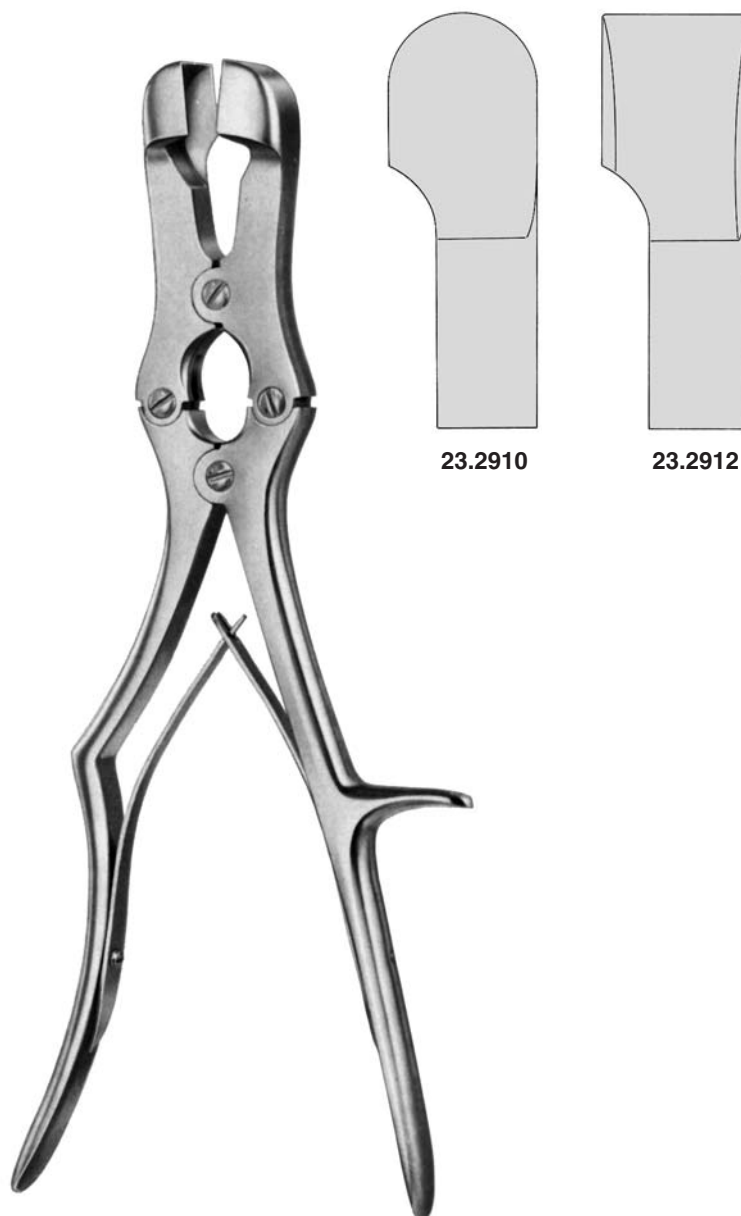

23.2910

23.2912

SAUERBRUCH
30 cm



23.3122

23.3123

RUSKIN-LISTON
19 cm



23.3150

23.3151

STILLE-LISTON
27 cm

Rippenscheren
Rib Shears
Costotomes
Costótomos



STILLE-HORSLEY
23.3161 27 cm

Rippenscheren
Rib Shears
Costotomes
Costótomos



STILLE-HORSLEY
23.3162 27 cm 90°



40.0008
23 cm



40.0010
22 cm



GLUCK
40.0020
22 cm



STILLE
40.0030
21 cm

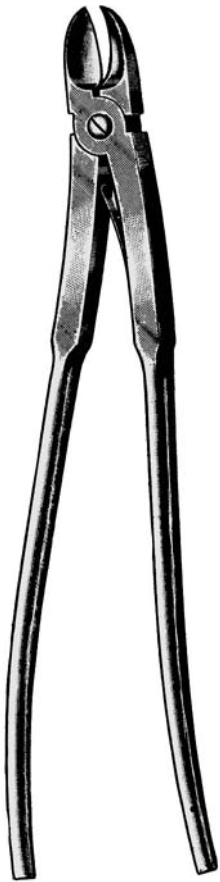

BETHUNE
40.0040
34 cm



CORYLLOS-BETHUNE
40.0047 35 cm
links / left
à gauche / izquierda



CORYLLOS-BETHUNE
40.0046 35 cm
rechts / right
à droite / derecha



STILLE-GIERTZ
40.0060
25 cm

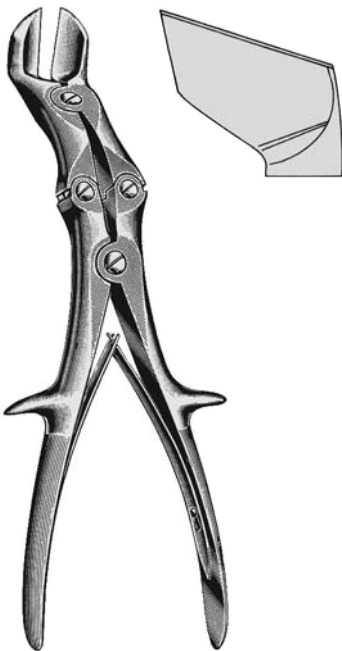

STILLE-HORSLEY
(Liston-Key)
40.0062
25 cm

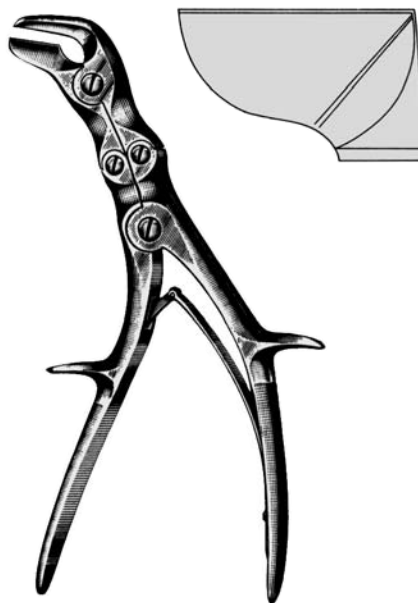

SEMB
40.0080
24 cm



SAUERBRUCH
40.0090
26 cm



SAUERBRUCH-FREY
40.0095
36 cm



LEBSCHE
40.0100
25 cm



Sternummeißel
Sternum Chisel
Cisaille à sternum
Cinzel para esternón

LEBSCHE
40.0110
25 cm



BRUNNER
40.0120 32 cm
40.0121 32 cm
linkshändig/left-handed
pour gaucher/para zurdo



SCHUMACHER
40.0130
21 cm

Sternumschere
Sternum shears
Ciseau-burins
Tijeras de esternón



für Kinder
for Children
pour enfants
para niños

DEBAKEY
40.0430
mit 3 Paar Valven
with 3 pairs of blades
avec 3 paires de valves
con 3 pares de valvas
(40.0432, 40.0433, 40.0434)

DEBAKEY
40.0431
220x180x150mm
Sperrer allein
Spreader only
Ecarteur, seul
Separador, suelto

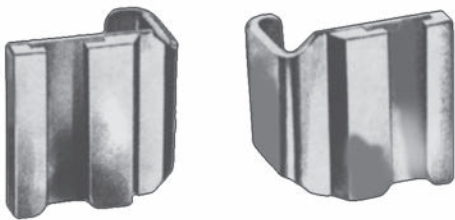

DEBAKEY
40.0432
30 x 30 mm

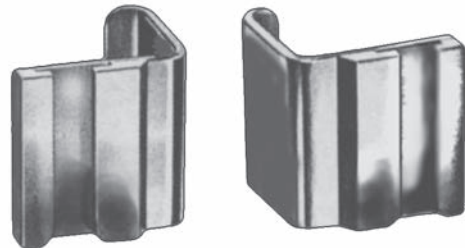

DEBAKEY
40.0433
40 x 40 mm

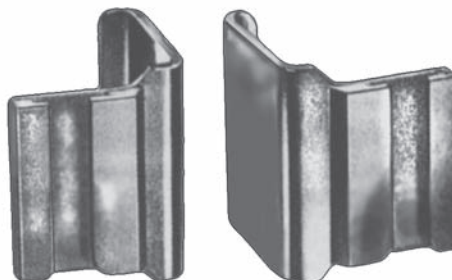

DEBAKEY
40.0434
50 x 50 mm

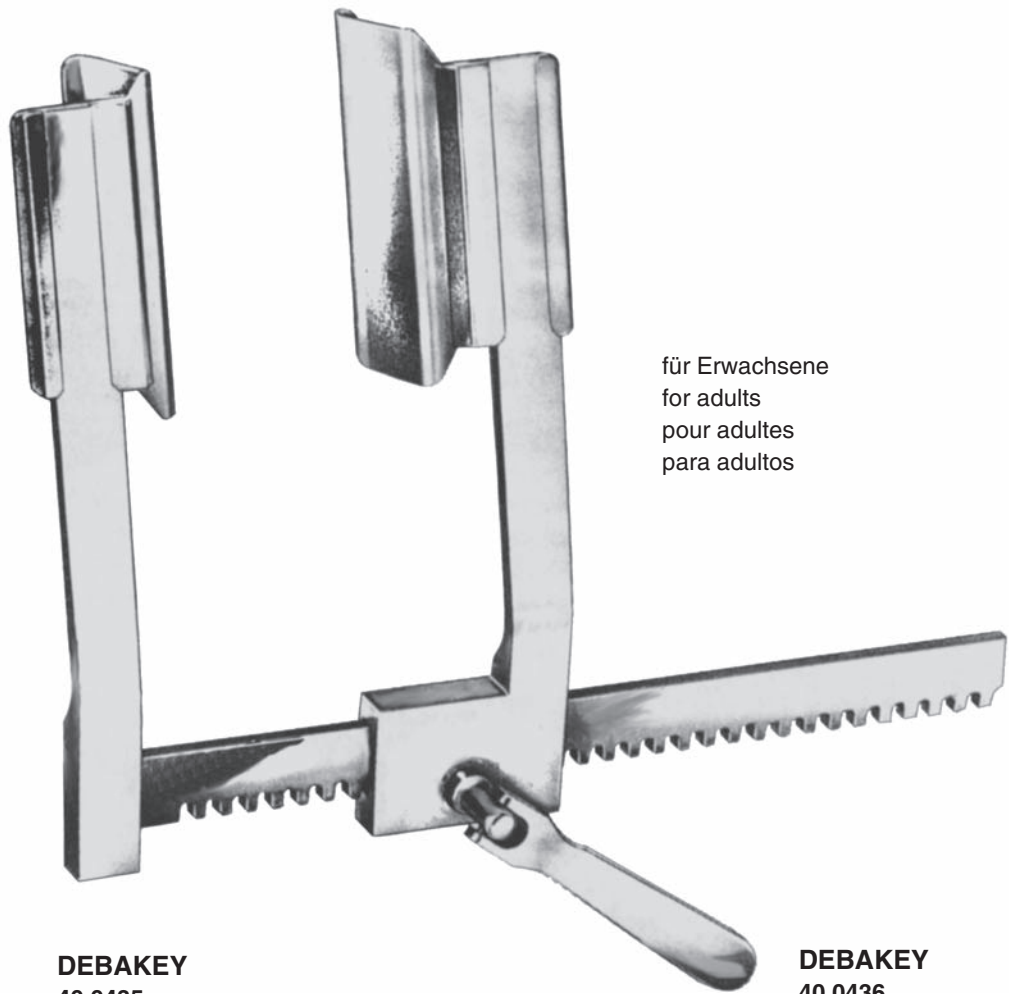

für Erwachsene
for adults
pour adultes
para adultos

DEBAKEY
40.0435
mit 3 Paar Valven
with 3 pairs of blades
avec 3 paires de valves
con 3 pares de valvas
(40.0437, 40.0438, 40.0439)

DEBAKEY
40.0436
285x225x200mm
Sperrer allein
Spreader only
Ecarteur, seul
Separador, suelto

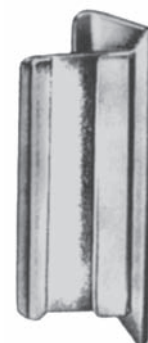
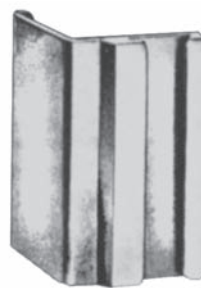
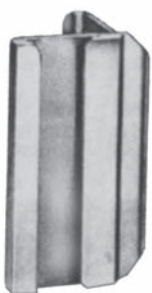

DEBAKEY
40.0437
60 x 60 mm

DEBAKEY
40.0438
50 x 80 mm

DEBAKEY
40.0439
40 x 100 mm

ALUMINIUM



für Neugeborene
new-born size
pour nourissons
tamaño de recién nacido

COOLEY

	a	b	c
40.0450	12 mm	17 mm	75 mm



für Kleinkinder
infant size
pour petits enfants
tamaño de bebé

ALUMINIUM

COOLEY

	a	b	c
40.0451	16 mm	30 mm	105 mm
40.0452	21 mm	44 mm	150 mm

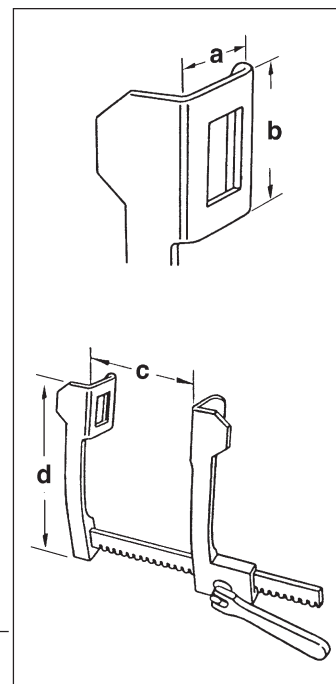

ALUMINIUM

für Erwachsene
for adults
pour adultes
para adultos

COOLEY

	a	b	c
40.0454	37 mm	49 mm	200 mm



ALUMINIUM

COOLEY "XL"

	a	b	c	d
40.0456	35 mm	100 mm	230 mm	165 mm



MORSE-COOLEY
40.0461
 für Kleinkinder
 infant size
 pour petits enfants
 tamaño de bebé



MORSE-COOLEY
40.0462
 für Kleinkinder
 infant size
 pour petits enfants
 tamaño de bebé

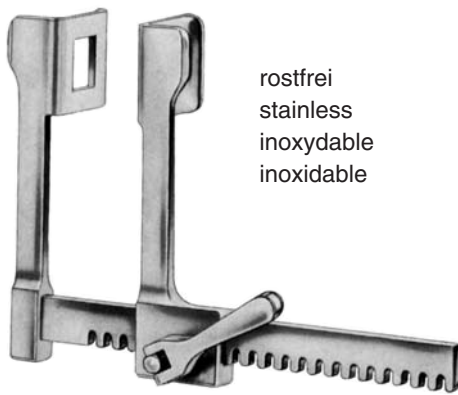

FINOCCHIETTO

	a	b	c
40.0500	18 mm	20 mm	75 mm

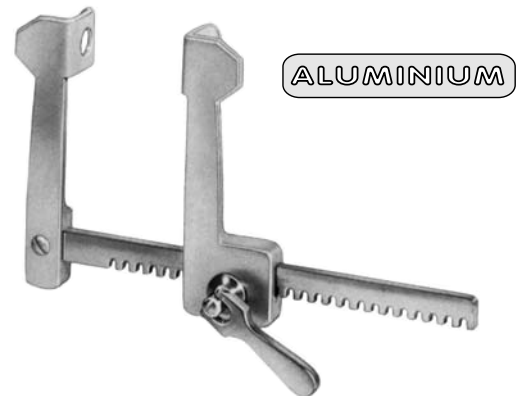

FINOCCHIETTO-BABY-HAIGHT

	a	b	c
40.0501	15 mm	15 mm	75 mm

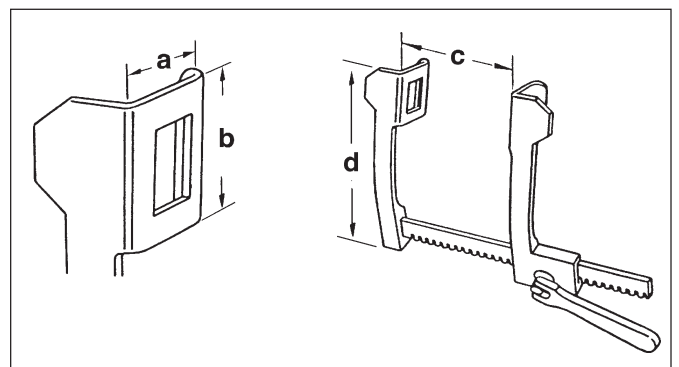



ALUMINIUM

FINOCCHIETTO-MODIF.

	a	b	c	d
40.0506	14 mm	14 mm	120 mm	110 mm

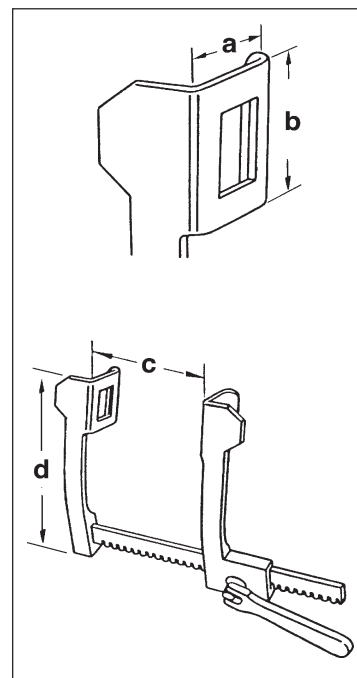

rostfrei
stainless
inoxydable
inoxidable

FINOCCHIETTO-BABY-HAIGHT

	a	b	c
40.0510	30 mm	30 mm	100 mm



ALUMINIUM

FINOCCHIETTO-BABY-HAIGHT

	a	b	c
40.0511	31 mm	31 mm	100 mm

ALUMINIUM



für Kinder
child size
pour enfants
tamaño de niño

MORSE-FAVALORO
40.0520

ALUMINIUM



für Erwachsene
for adults
pour adultes
para adultos

MORSE-STERNAL
40.0523

ALUMINIUM



für Erwachsene
for adults
pour adultes
para adultos

MORSE-STERNAL
40.0525

ALUMINIUM



für Neugeborene
new-born size
pour nourissons
tamaño de recién nacido

CASTANEDA

	a	b	c
40.0531	10.5 mm	32 mm	65 mm

ALUMINIUM

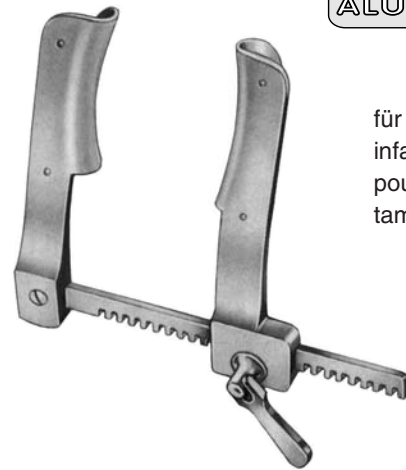

für Kleinkinder
infant size
pour petits enfants
tamaño de bebé

CASTANEDA

	a	b	c
40.0533	12 mm	45 mm	70 mm

ALUMINIUM



für Kinder
child size
pour enfants
tamaño de niño

CASTANEDA

	a	b	c
40.0535	15 mm	60 mm	120 mm

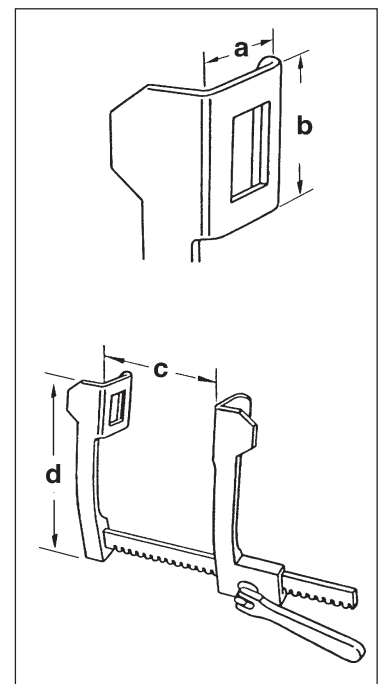



TUFFIER

	a	b	c
40.0540	50 mm	45 mm	165 mm

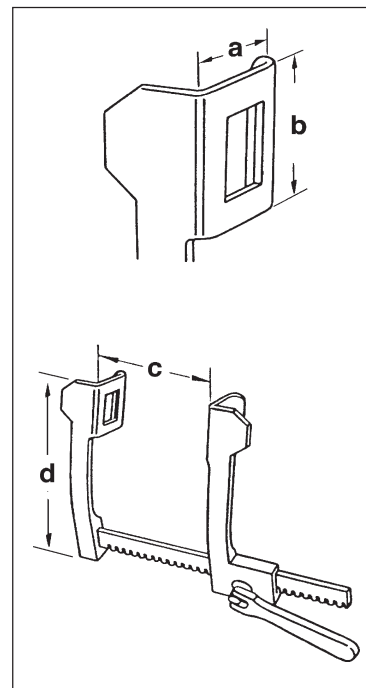

FINOCHIETTO

40.0550	38 x 44 mm	40.0551
40.0552	56 x 62 mm	40.0553
40.0554	65 x 85 mm	40.0555
rostfrei		Aluminium
stainless		aluminium
inoxydable		aluminium
inoxidable		aluminio

ALUMINIUM



mit 2 Paar Valven
with 2 pairs of blades
avec 2 paires de valves
con 2 pares de valvas

BURFORD-FINOCCHIETTO

	a	b	c
40.0561	47 mm 65 mm	62 mm 62 mm	200 mm
40.0563	47 mm 65 mm	62 mm 62 mm	260 mm
40.0565	47 mm 65 mm	62 mm 62 mm	300 mm

Valven / blades / valves / valvas:

40.0567	47 mm	62 mm
40.0568	65 mm	62 mm

ALUMINIUM



für Kinder
child size
pour enfants
tamaño de niño

mit 2 Paar Valven
with 2 pairs of blades
avec 2 paires de valves
con 2 pares de valvas

BURFORD

	a	b	c
40.0569	34 mm 48 mm	42 mm 42 mm	135 mm



rostfrei
 stainless
 inoxydable
 inoxidable

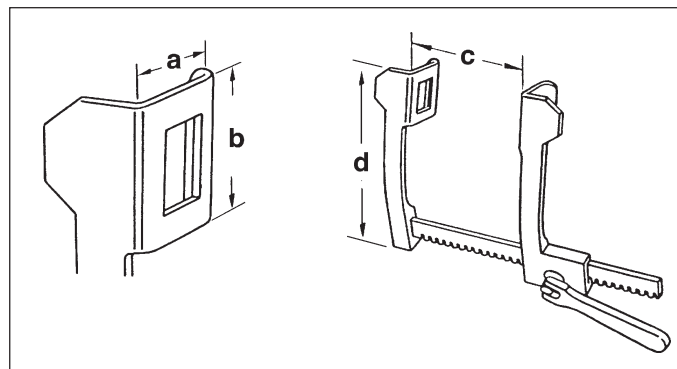

DE BOER

	a	b	c
40.0570	27 mm	100 mm	190 mm

ALUMINIUM



mit 2 Paar Valven
 with 2 pairs of blades
 avec 2 paires de valves
 con 2 pares de valvas

DEBAKEY

	a	b	c
40.0581	12 mm 15 mm	15 mm 15 mm	70 mm
40.0583	21 mm 30 mm	30 mm 30 mm	120 mm
40.0585	52 mm 60 mm	60 mm 60 mm	200 mm



75 x 75 mm

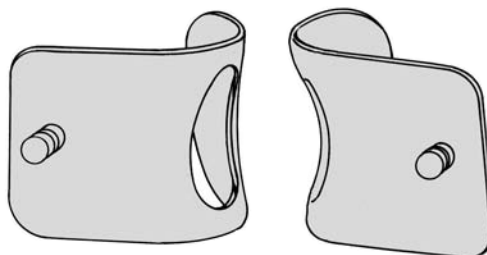

42 x 65 mm

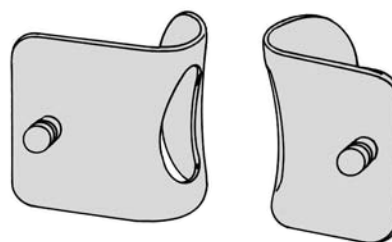

MERCEDES
40.0590
240 mm



SELLORS
40.0600
19 cm

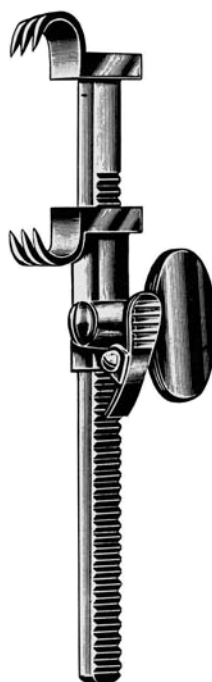

BAILEY
40.0610
16 cm



BAILEY-BABY
40.0612
14 cm

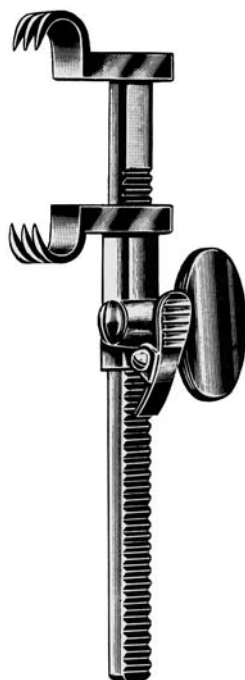

BAILEY-GIBBON
40.0620
16 cm



LEMMON
40.0630
18 cm

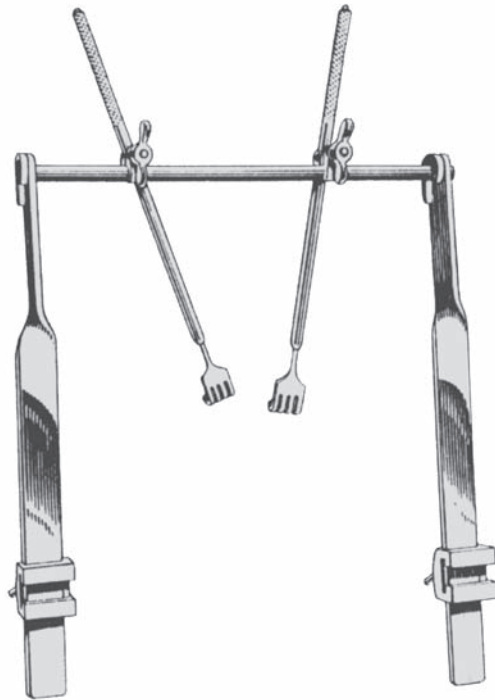

FAVALORO
40.0650

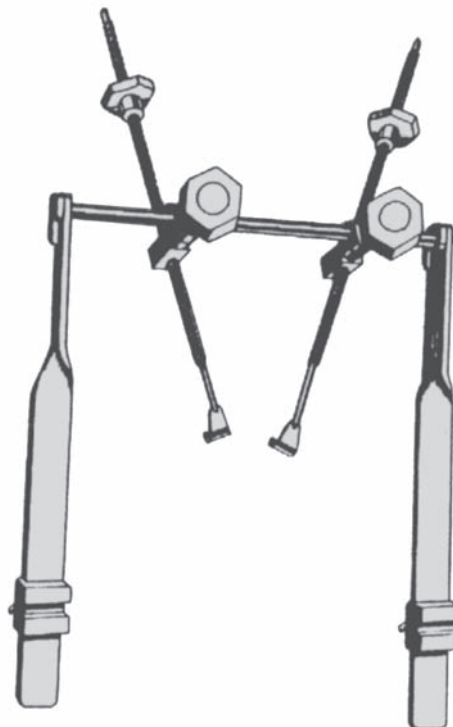

FAVALORO-OCHSNER
40.0660



HARRINGTON
40.0701
30,5 cm

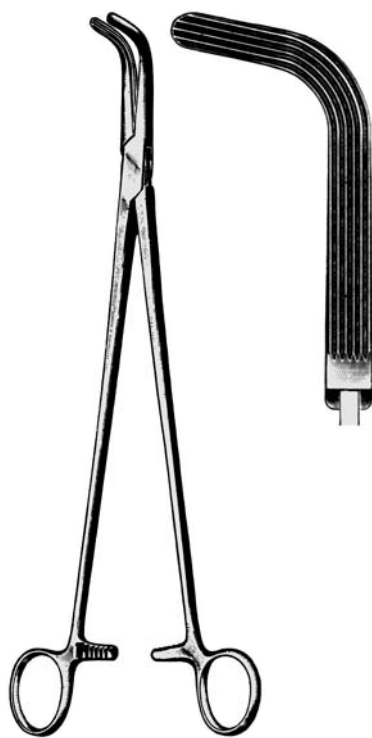

HARRINGTON
40.0702
29,5 cm

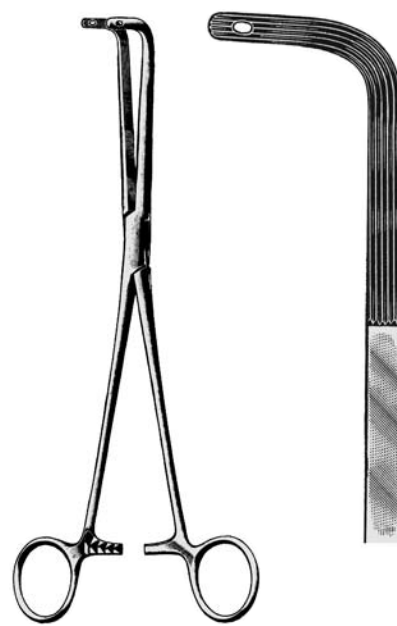

FINOCCHIETTO
40.0720
24 cm

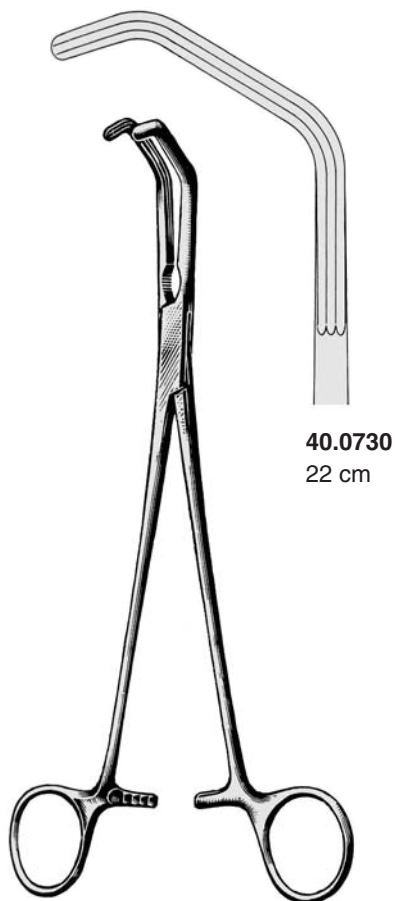

PRICE-THOMAS

40.0730
22 cm



BRONCHUS
23 cm

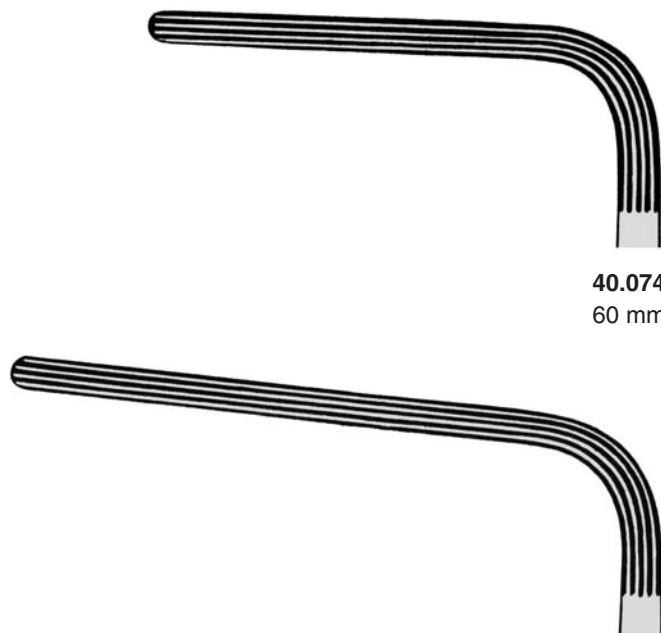

40.0740
60 mm

40.0742
80 mm



LOVELACE
40.0750
20 cm



LOVELACE
40.0751
20 cm



SEMB



40.0761
24 cm #1

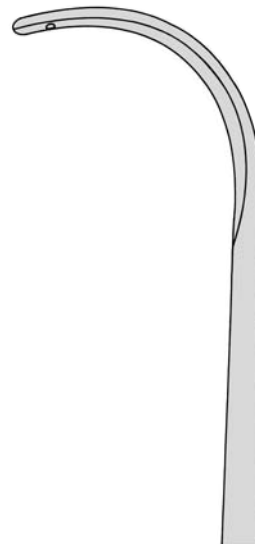

40.0763
24 cm #2

Anastomosenklemmen
 Anastomosis Clamps
 Pincés pour anastomoses
 Pinzas para anastomosis



COOLEY-DERRA

17 cm

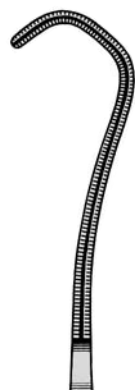

40.0901

#1

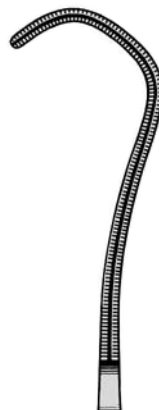

40.0905

#2

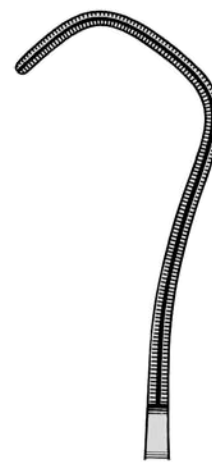

40.0910

#3

Neonatal- und Kinderklemmen
 Neonatal and Pediatric Clamps
 Pince-Clamps pour nouveaux-nés et enfants
 Pinzas-Clamps para recién nacidos y niños

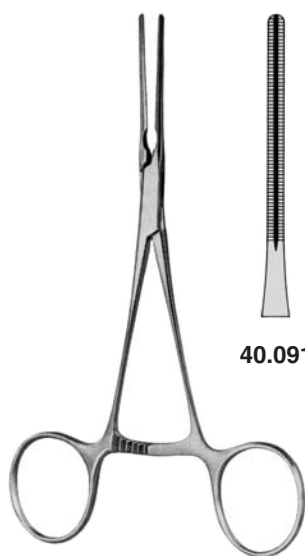

COOLEY

14 cm

40.0911

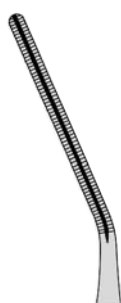

40.0912

30°

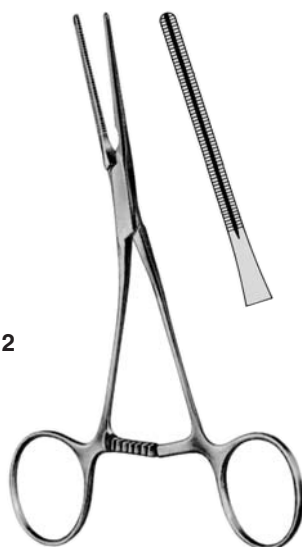

COOLEY

40.0913

14 cm



COOLEY

40.0914

14 cm



COOLEY-SATINSKY

40.0915

14 cm

Mehrzweckklemmen
Multi-Purpose Forceps
Pinces pour application universelle
Pinzas de multiple propósito

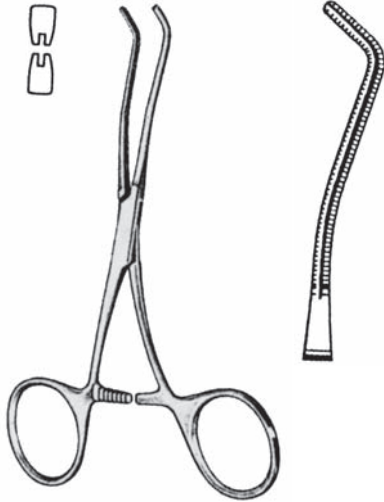

COOLEY
40.0920
13,5 cm

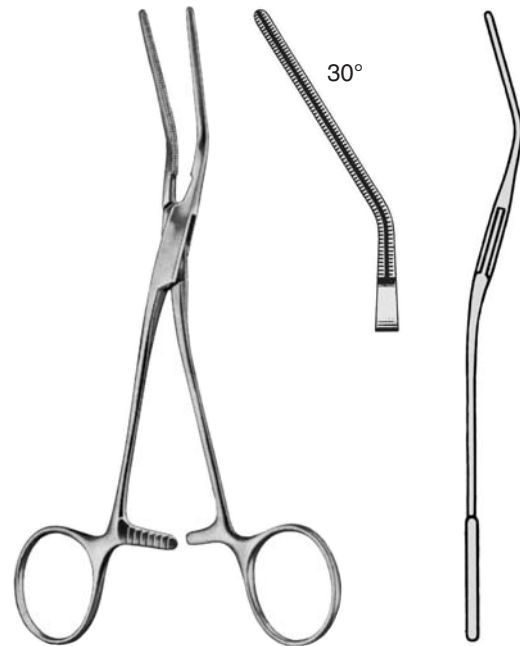

COOLEY
40.0925
17 cm / 30°



COOLEY
40.0930
15,5 cm / 60°



COOLEY
40.0935
15,5 cm / 90°

Anastomosenklemmen
Anastomosis Forceps
Pinces pour anastomoses
Pinzas para anastomosis



COOLEY

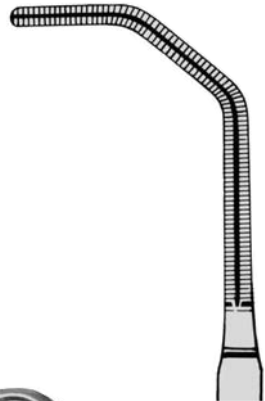

40.0950
17,5 cm

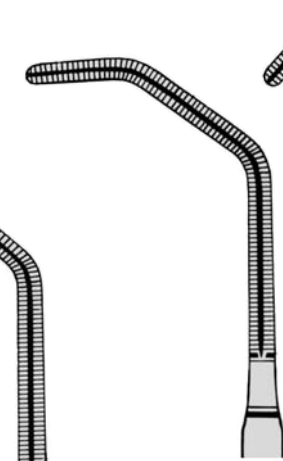

40.0955
17,5 cm

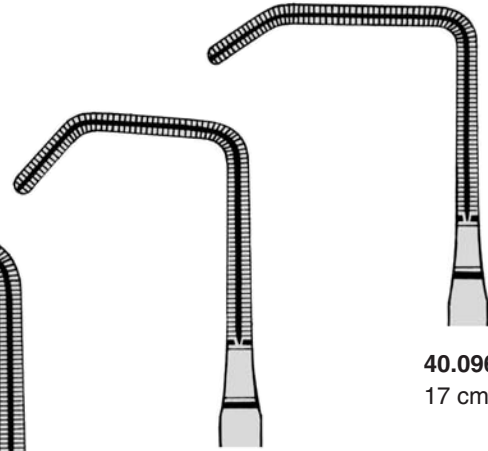

40.0960
17 cm

40.0965
17 cm



COOLEY
40.0976
17 cm

Patent-Ductus- und Coarctationsklemmen
Patent-Ductus- and Coarctation Forceps
Pinces pour canal artériel et à coarctation
Pinzas patente con ducto



COOLEY
40.1000
15,5 cm



COOLEY
40.1005
15,5 cm

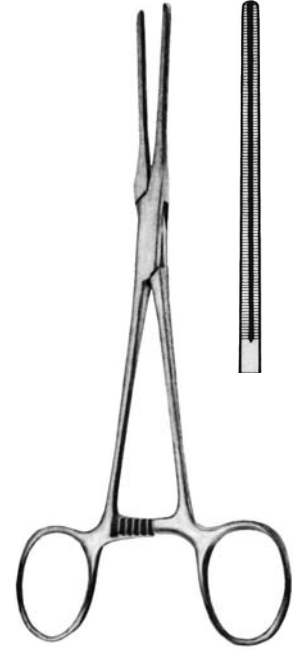

COOLEY
40.1025
17 cm

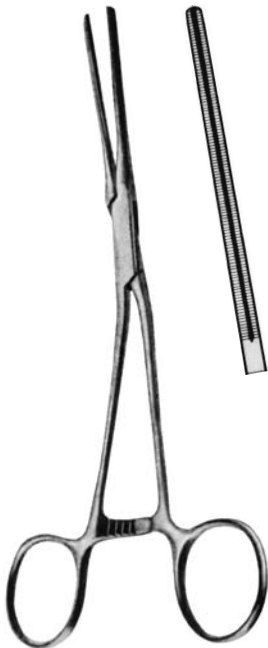

COOLEY
40.1030
17 cm

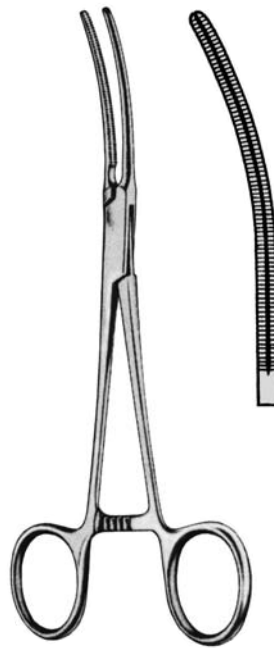

COOLEY
40.1035
17 cm

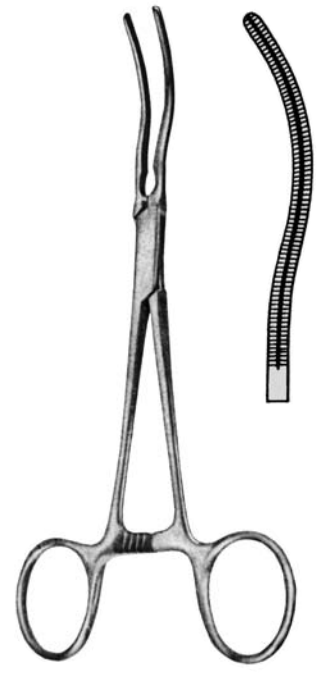

COOLEY
40.1036
17,5 cm

Anastomosenklemmen
 Anastomosis Forceps
 Pinces pour anastomoses
 Pinzas para anastomosis

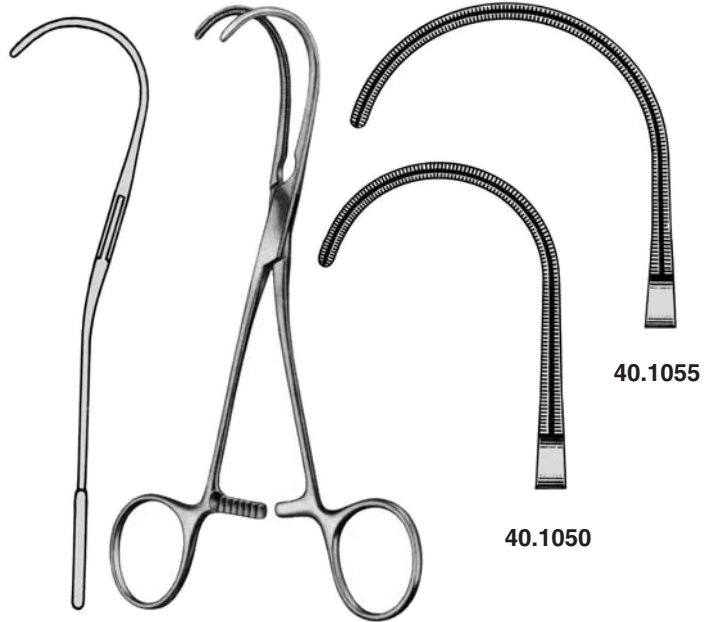

COOLEY-BECK
 15 cm

40.1055

40.1050

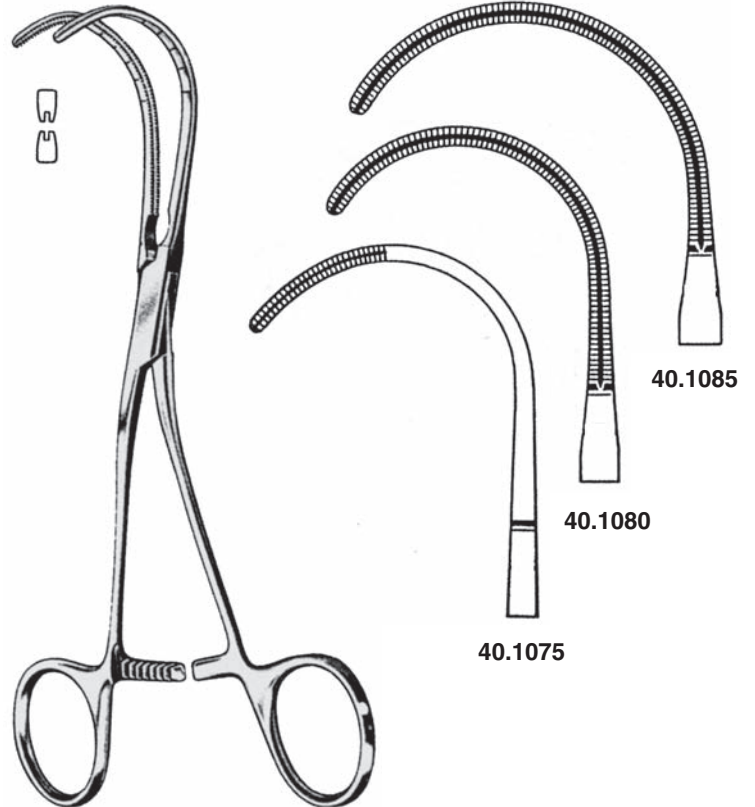

COOLEY
 17 cm

40.1080

40.1075

40.1085

Nierenstiellklemmen
 Renal Artery Clamps
 Pinces pour artère rénal
 Pinzas para las arterias renales

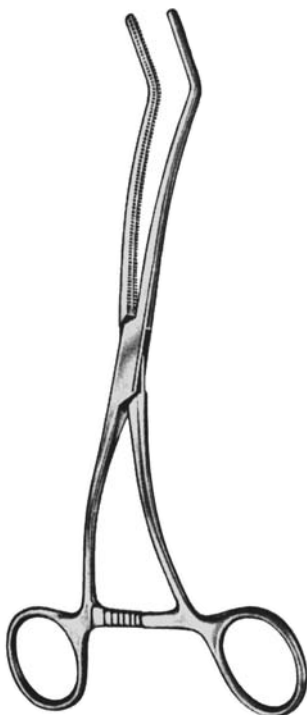

COOLEY

40.1090
 18,5 cm

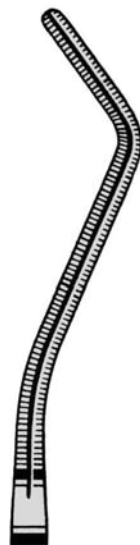

40.1091
 20 cm

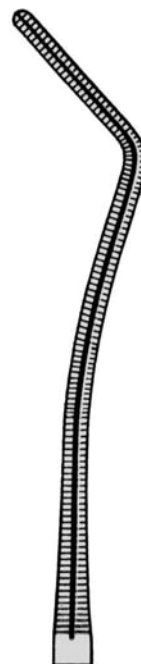

40.1092
 28 cm

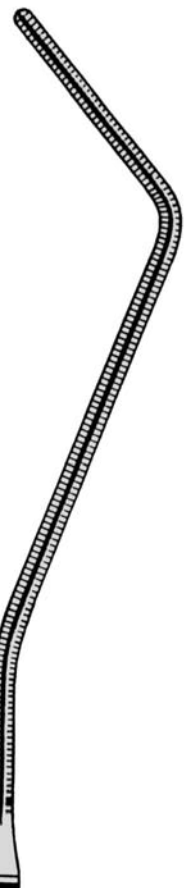

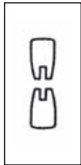

COOLEY

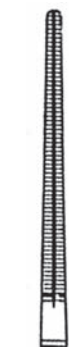

40.1150
12,5 cm

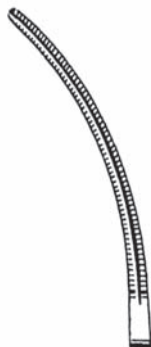

40.1152
12,5 cm

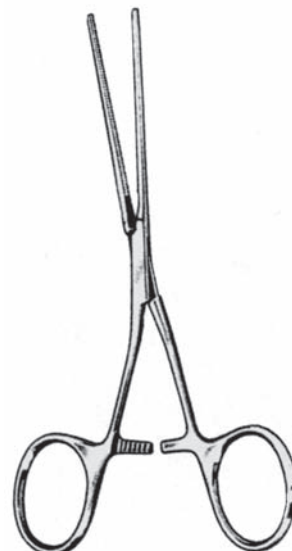

COOLEY

40.1151
13,5 cm/15°



Atraumatische Bulldogklemmen
 Ring Handle Bulldog Clamps
 Clamps Bulldog non traumatisants
 Clamps Bulldog atraumáticas



COOLEY

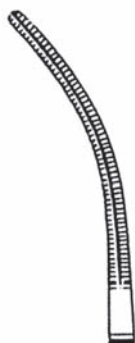

40.1153
13 cm



40.1154
12,5 cm/45°

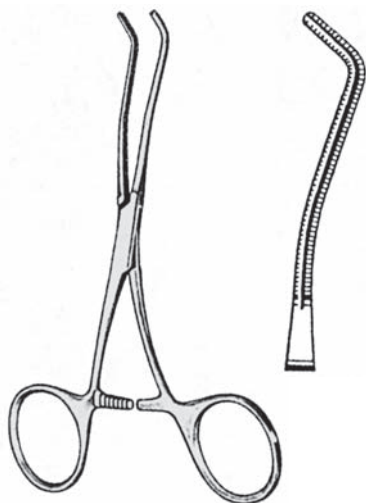

COOLEY

40.1155
13,5 cm



COOLEY

40.1157
10,5 cm/90°

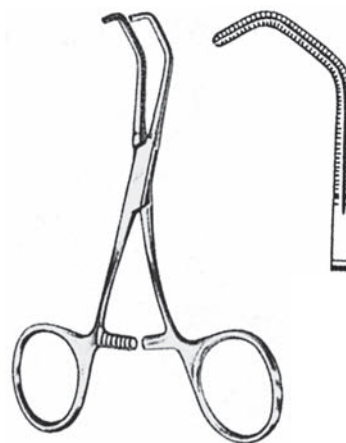

COOLEY

40.1158
12 cm

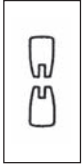

COOLEY



40.1300
21 cm



40.1302
22 cm



40.1304
26 cm

Patent-Ductusklemmen
 Patent Ductus Clamps
 Clamps patent-ductus
 Pinzas patente de conducto

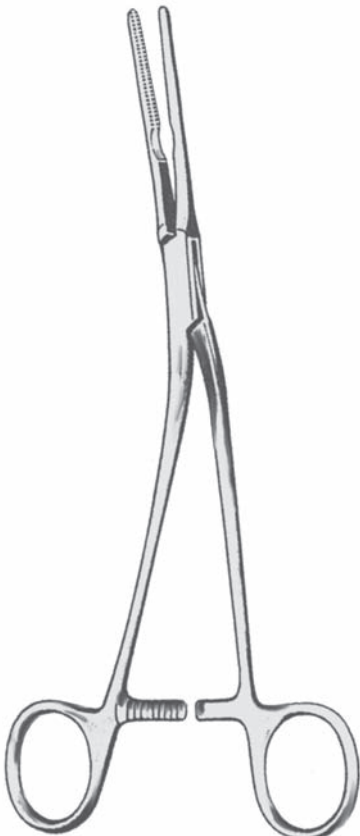

COOLEY



40.1301
20,5 cm



40.1303
22 cm



40.1305
25,5 cm

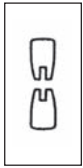

Mehrzweckklemmen
Multi-Purpose Clamps
Clamps à usage multiple
Pinzas de multiple propósito



COOLEY

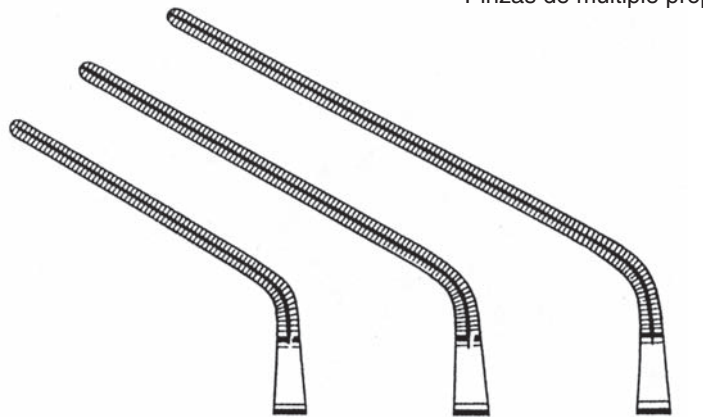

40.1333
16 cm

40.1334
17 cm

40.1335
18 cm



JAVID



40.1340
17 cm

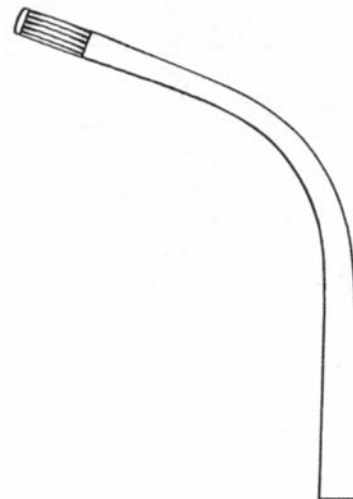

40.1342
19 cm

Karotisklemmen
Carotid Clamps
Pinces-Clamps pour la carotide
Pinza-clamp para carótide

Vena Cava Verschlussklemmen
 Vena Cava Occlusion Clamps
 Clamps pour occlusion de la veine cava
 Pinzas-Clamps para oclusión vena cava



COOLEY

40.1350	16 cm	24 Fr.
40.1351	16 cm	26 Fr.
40.1352	20 cm	28 Fr.
40.1353	20 cm	30 Fr.
40.1354	20 cm	32 Fr.
40.1355	20 cm	34 Fr.
40.1357	20 cm	36 Fr.

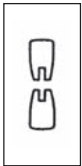

COOLEY

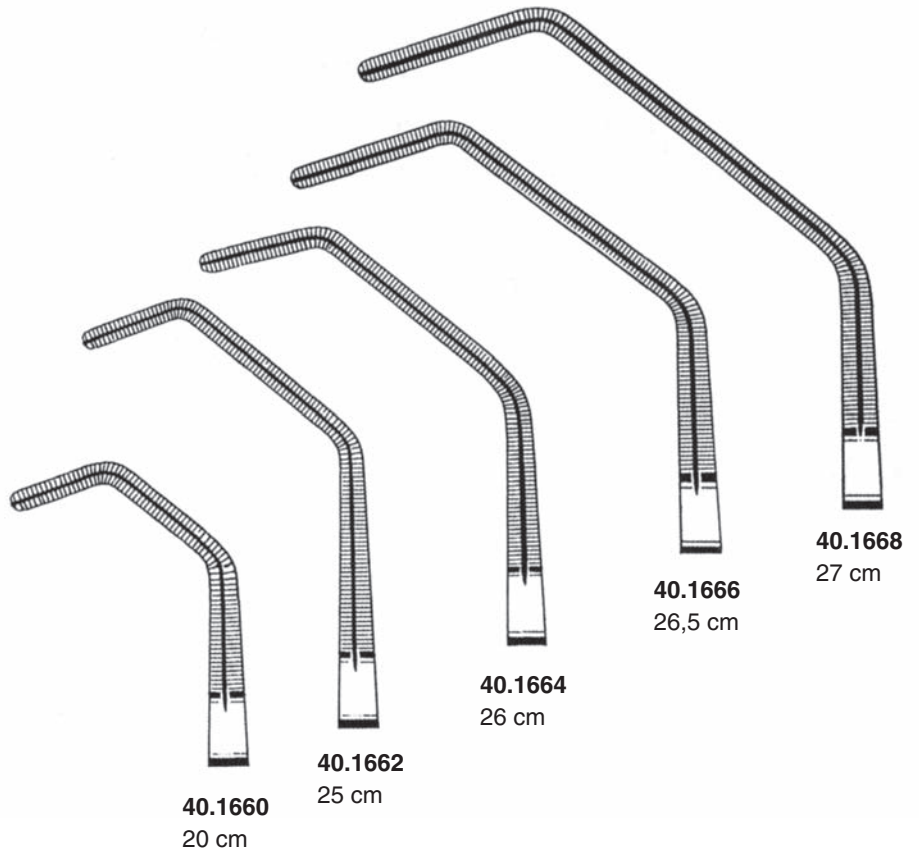

40.1660
20 cm

40.1662
25 cm

40.1664
26 cm

40.1666
26,5 cm

40.1668
27 cm

Gefäßklemmen für Tangential-Verschluss
 Tangential Occlusion Clamps
 Pincés-Clamps pour occlusion tangentielle
 Pinzas-clamps para oclusión tangencial

Klemmen für Arteria iliaca
 Iliac Forceps
 Pinces pour artère iliaque
 Pinzas para la arteria iliaca



COOLEY



40.1690
22 cm

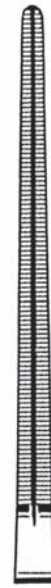

40.1691
26 cm



COOLEY
40.1698
30 cm

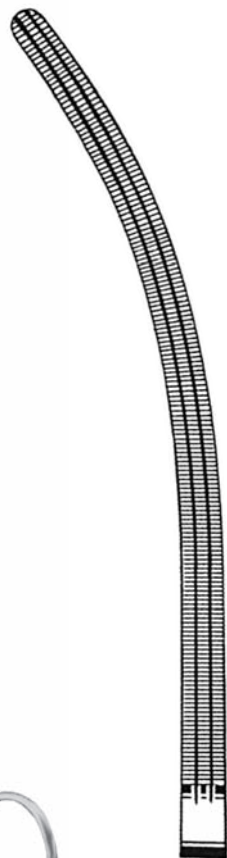

Mehrweckklemmen
 Multi-purpose Clamps
 Pinces-clamps à usage multiple
 Pinzas-clamps de multiple propósito

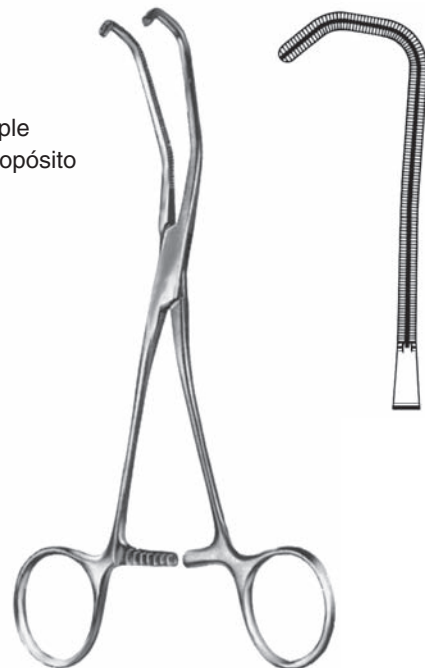

COOLEY
40.1729
17 cm

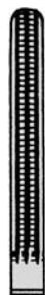

40.1750
15 cm



40.1751
15 cm
15°

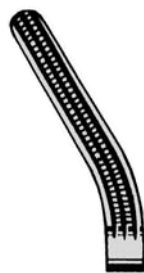

40.1752
15 cm
30°

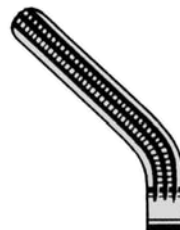

40.1753
14 cm
45°

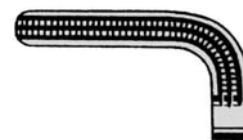

40.1754
13 cm
90°

Mehrzweckklemmen
 Multi-purpose Clamps
 Pincés-clamps à usage multiple
 Pinzas-clamps de multiple propósito

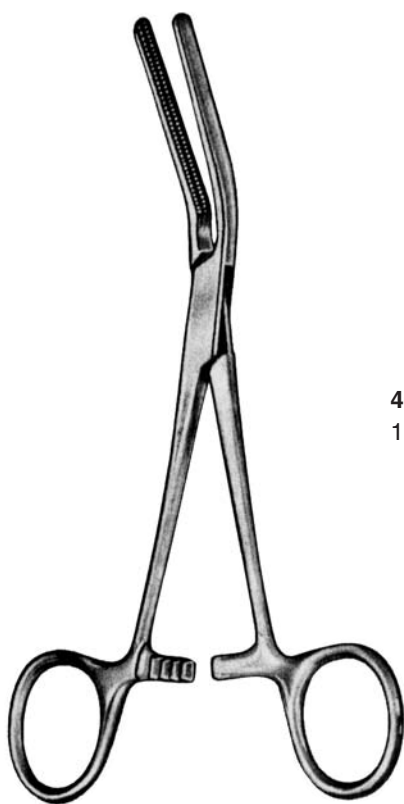

DARDICK



40.1760
17 cm

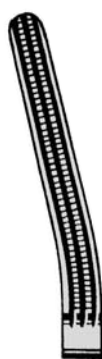

40.1761
17 cm
15°

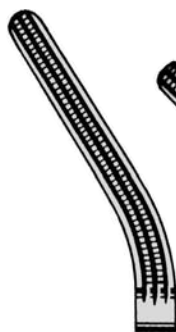

40.1762
17 cm
30°



40.1763
16 cm
45°

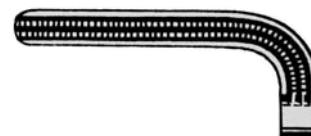

40.1764
14 cm
90°



COOLEY
40.1765
28 cm

Mehrzweckklemmen
Multi-purpose Clamps
Pinces-clamps à usage multiple
Pinzas-clamps de multiple propósito



COOLEY

40.1769
22 cm

40.1770
27 cm

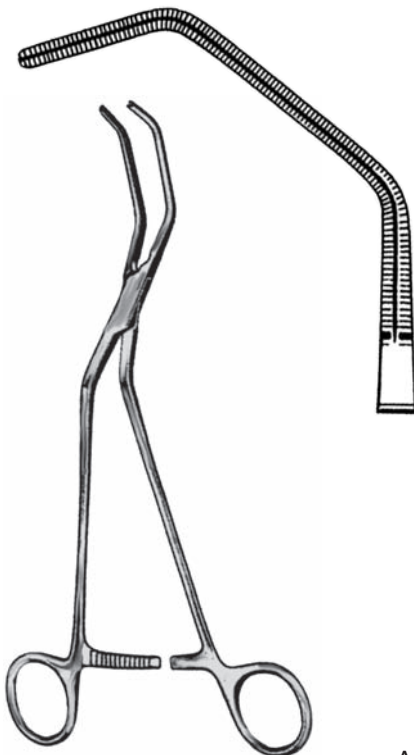

COOLEY
40.1773
26 cm

Anastomosenklemmen
Anastomosis Clamps
Pinces pour anastomoses
Pinzas para anastomosis

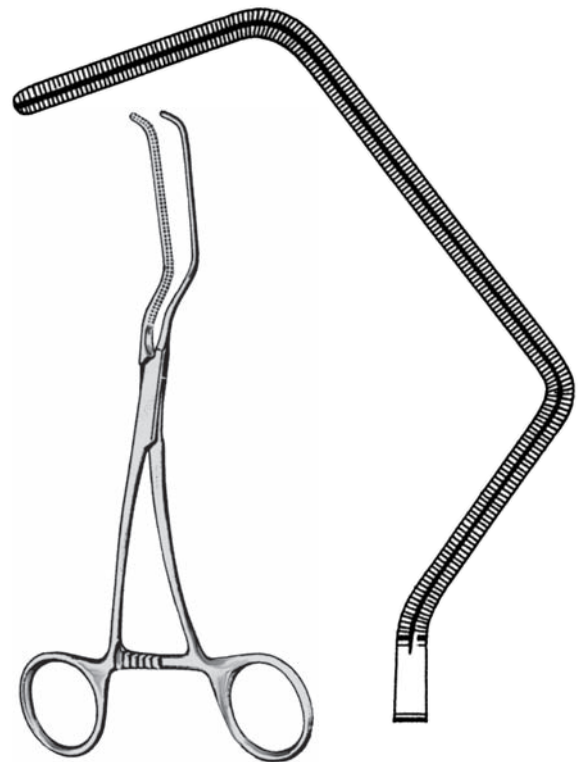

COOLEY-PARRY
40.1775
26 cm

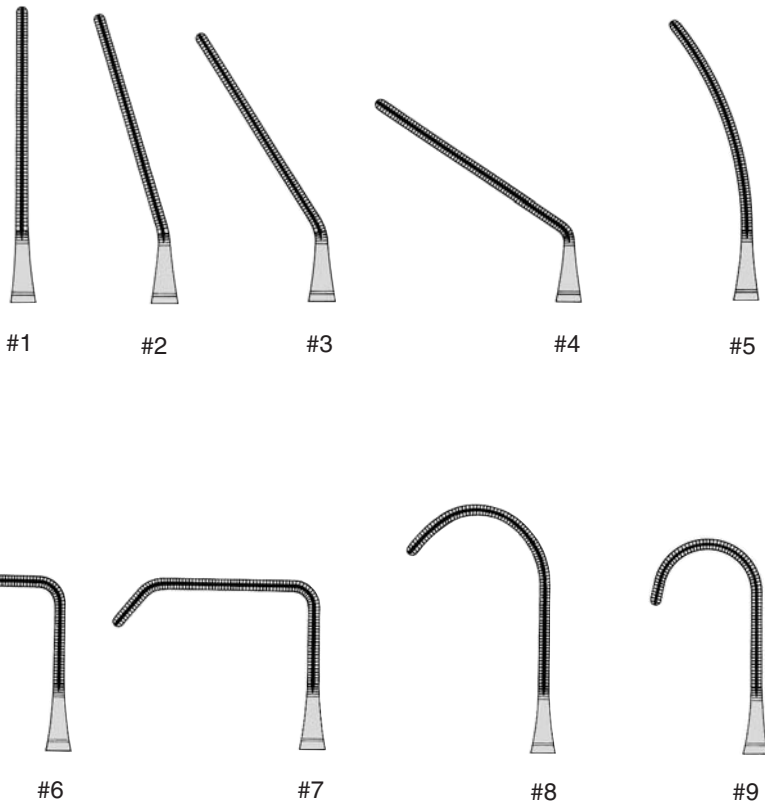

gerade
 straight
 droit
 recto

abgewinkelt
 angled
 angulaires
 angulares

gebogen
 curved
 courbe
 curvo

40.2001	14,5 cm	#1
40.2002	14,5 cm	#2
40.2003	14,5 cm	#3
40.2004	13,5 cm	#4
40.2005	14 cm	#5
40.2006	13,5 cm	#6
40.2007	13,5 cm	#7
40.2008	14 cm	#8
40.2009	13,5 cm	#9

40.2021	14,5 cm	#1
40.2022	14,5 cm	#2
40.2023	14,5 cm	#3
40.2024	13,5 cm	#4
40.2025	14 cm	#5
40.2026	13,5 cm	#6
40.2027	13,5 cm	#7
40.2028	14 cm	#8
40.2029	13,5 cm	#9

40.2041	14 cm	#1
40.2042	14 cm	#2
40.2043	14 cm	#3
40.2044	13 cm	#4
40.2045	14 cm	#5
40.2046	13 cm	#6
40.2047	13 cm	#7
40.2048	14 cm	#8
40.2049	13 cm	#9



CASTANEDA

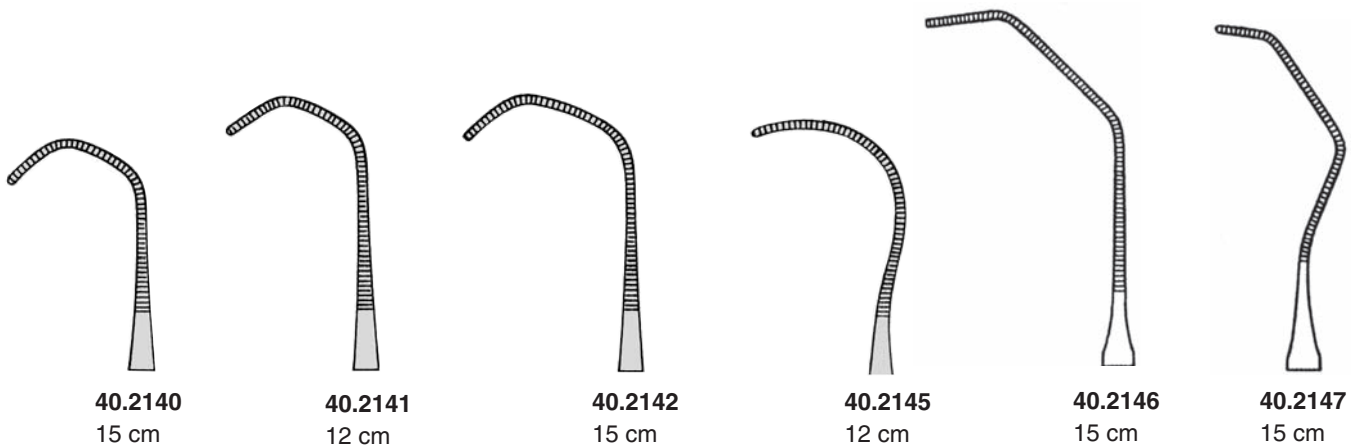
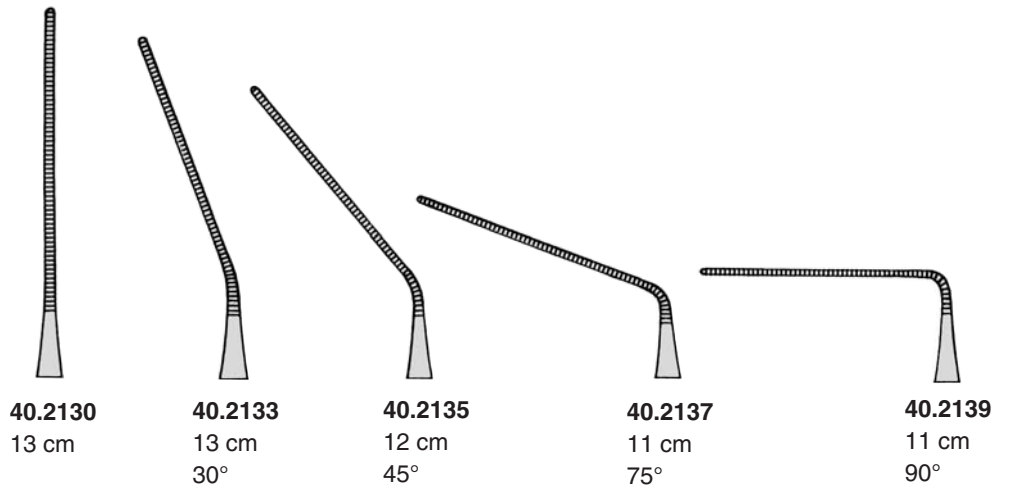



COOLEY-BABY



40.2150
14,5 cm
Fig.1



40.2151
14,5 cm
Fig.2



40.2152
14,5 cm
Fig.3



40.2153
14,5 cm
Fig.4



40.2154
14,5 cm
Fig.5



40.2155
14,5 cm
Fig.6



40.2156
14,5 cm
Fig.7



40.2157
14,5 cm
Fig.8



40.2158
14,5 cm
Fig. 9



40.2159
14,5 cm
Fig.10

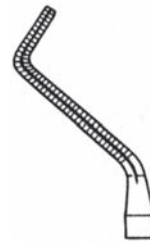

40.2160
14,5 cm
Fig.11

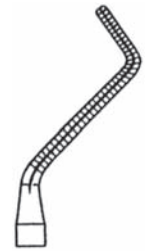

40.2161
14,5 cm
Fig.12



NEONATAL
40.2588
16,5 cm



NEONATAL
40.2589
16 cm



NEONATAL
40.2590
15 cm



NEONATAL
40.2591
15 cm



NEONATAL
40.2592
15,5 cm



GLOVER

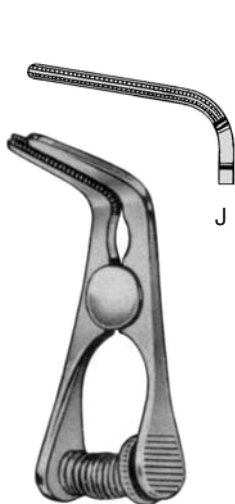

GLOVER

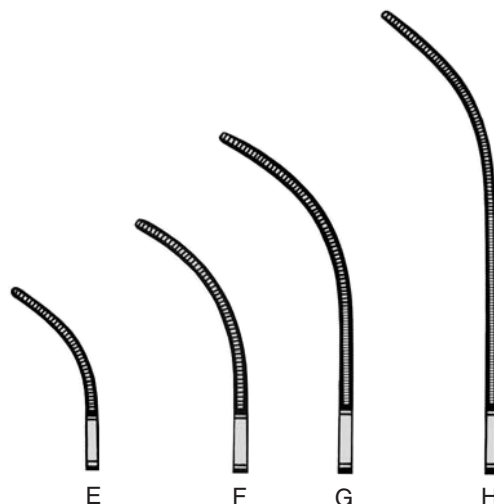

Artikel Item	Fig.	Gesamtänge Overall length Longeur complet largo total	Maullänge Jaw length longeur de mors largo de boca	Gewicht Weight Poids Peso
41.0000	A	60 mm	20 mm	5 g
41.0001	E	55 mm	20 mm	5 g
41.0005	B	70 mm	30 mm	9 g
41.0006	F	65 mm	30 mm	9 g
41.0010	C	90 mm	43 mm	12 g
41.0011	G	85 mm	43 mm	12 g
41.0015	D	105 mm	56 mm	14 g
41.0016	H	100 mm	56 mm	14 g
41.0019	J	55 mm	25 mm	7 g



GREGORY

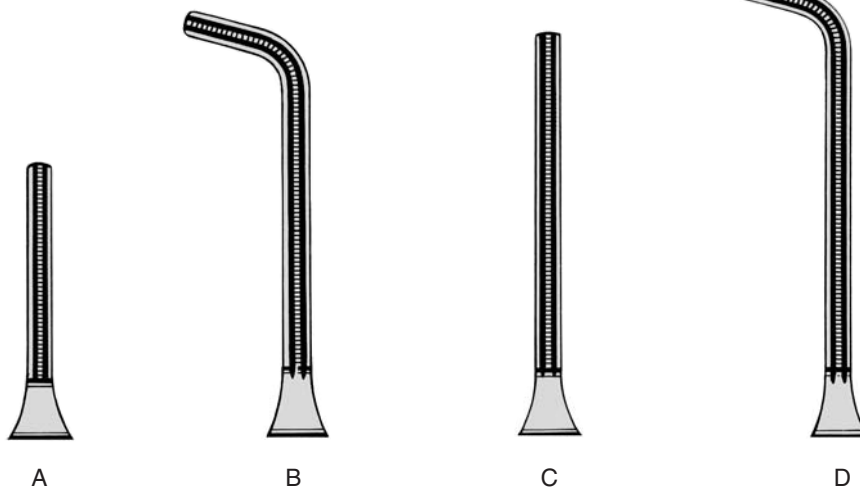

Artikel Item	Fig.	Gesamtänge Overall length Longeur complet largo total	Maullänge Jaw length longeur de mors largo de boca	Gewicht Weight Poids Peso
41.0020	A	90 mm	27 mm	11 g
41.0021	B	100 mm	44 mm	12 g
41.0022	C	110 mm	55 mm	12 g
41.0023	D	110 mm	60 mm	12 g



GREGORY

nach links gebogen
curved to left
courbe à gauche
curva a la izquierda



A

nach rechts gebogen
curved to right
courbe à droit
curva a la derecha



B

Artikel Item	Fig.	Gesamtänge Overall length Longeur complet largo total	Maullänge Jaw length longeur de mors largo de boca	Gewicht Weight Poids Peso
41.0024	A	110 mm	60 mm	12 g
41.0025	B	110 mm	60 mm	12 g

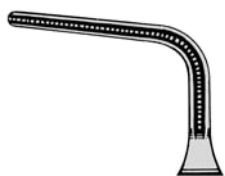
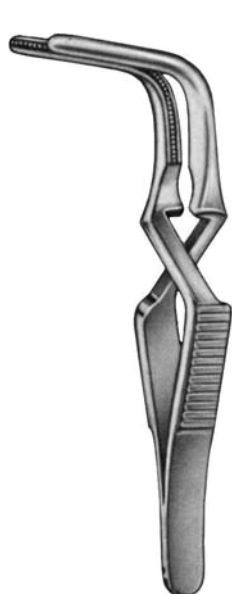

30 mm Maullänge
 Jaw length
 longueur de mors
 largo de boca

SANTULLI
 41.0028
 70 mm



DIETRICH



A

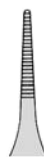

B



C



D

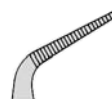

E

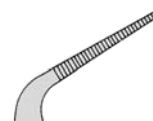

F

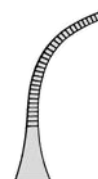

G

Artikel Item	Fig.	Gesamtänge Overall length Longeur complet largo total	Maullänge Jaw length longueur de mors largo de boca	Gewicht Weight Poids Peso	Schliesdruck Closing pressure Pression Compresión
41.0030	A	50 mm	8 mm	3 g	80
41.0031	D	43 mm	8 mm	3 g	80
41.0032	B	53 mm	12 mm	3 g	80
41.0033	E	45 mm	12 mm	3 g	80
41.0034	C	60 mm	20 mm	3 g	80
41.0035	F	50 mm	20 mm	3 g	80
41.0037	G	54 mm	20 mm	3 g	80

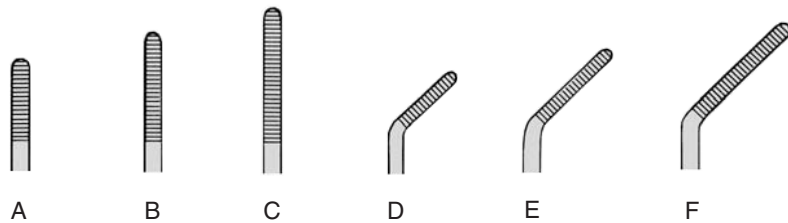

FEDERLEICHT • FEATHERLIGHT • POIDS PLUME • MUY LIGERO

Artikel Item	Fig.	Gesamtänge Overall length Longeur complet largo total	Maullänge Jaw length longeur de mors largo de boca	Gewicht Weight Poids Peso	Schliessdruck Closing pressure Pression Compresión
41.0040	A	31 mm	10 mm	1 g	30
41.0041	B	35 mm	14 mm	1 g	30
41.0042	C	39 mm	18 mm	1 g	30
41.0043	D	30 mm	10 mm	1 g	30
41.0044	E	33 mm	14 mm	1 g	30
41.0045	F	36 mm	18 mm	1 g	30

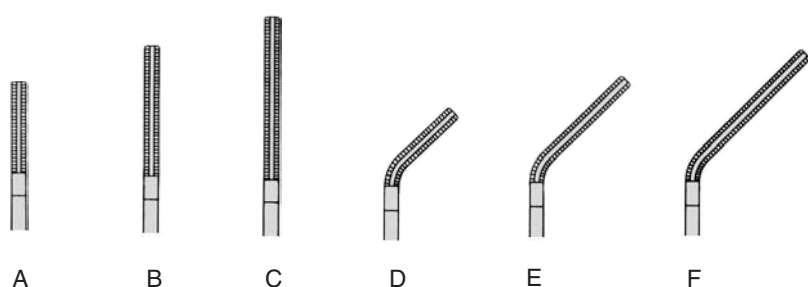

WICKHAM

Artikel Item	Fig.	Gesamtänge Overall length Longeur complet largo total	Maullänge Jaw length longeur de mors largo de boca	Gewicht Weight Poids Peso	Schliessdruck Closing pressure Pression Compresión
41.0080	A	49 mm	13 mm	3 g	150
41.0081	D	47 mm	13 mm	3 g	150
41.0082	B	54 mm	18 mm	3 g	150
41.0083	E	51 mm	18 mm	3 g	150
41.0084	C	61 mm	25 mm	3 g	150
41.0085	F	55 mm	25 mm	3 g	150

WICKHAM

41.0089 24 cm

Anlegezange / Applying forceps / Pincas de pose / Pinzas de aplicación

TITANIUM

Identification:

A = ARTERIA
 = closing force
 220 - 240 ± 10 g



3,0 cm

41.0050A
41.0050V



3,5 cm

41.0052A
41.0052V



4,0 cm

41.0054A
41.0054V



4,5 cm

41.0056A
41.0056V



3,0 cm

41.0051A
41.0051V



3,5 cm

41.0053A
41.0053V



4,0 cm

41.0055A
41.0055V



4,5 cm

41.0057A
41.0057V

V = VENA
 = closing force
 110 - 130 ± 10 g



3,0 cm

41.0061A
41.0061V



3,5 cm

41.0063A
41.0063V



4,0 cm

41.0065A
41.0065V



4,5 cm

41.0067A
41.0067V



**DEBAKEY-
MICRO**

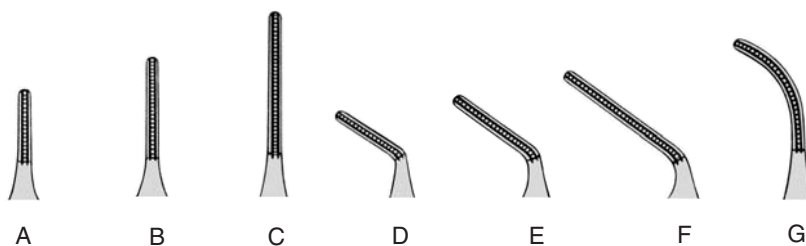

Artikel Item	Fig.	Gesamtänge Overall length Longeur complet largo total	Maullänge Jaw length longeur de mors largo de boca	Gewicht Weight Poids Peso	Schliessdruck Closing pressure Pression Compresión
41.0090	A	47 mm	10 mm	3 g	180
41.0091	D	44 mm	10 mm	3 g	180
41.0092	B	51 mm	14 mm	3 g	180
41.0093	E	46 mm	14 mm	3 g	180
41.0094	C	57 mm	20 mm	3 g	180
41.0095	F	49 mm	20 mm	3 g	180
41.0099	G	54 mm	20 mm	3 g	180

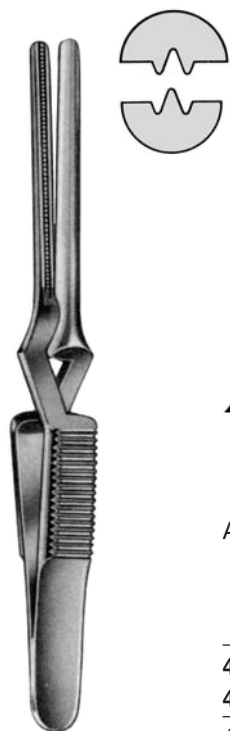

DEBAKEY

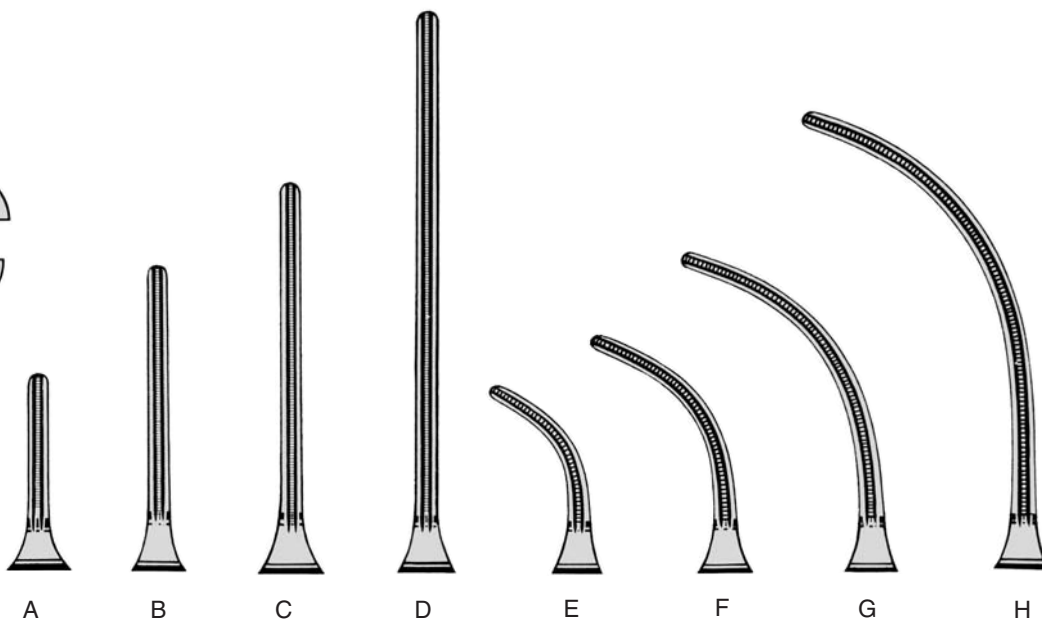

Artikel Item	Fig.	Gesamtänge Overall length Longeur complet largo total	Maullänge Jaw length longeur de mors largo de boca	Gewicht Weight Poids Peso
41.0100	A	80 mm	20 mm	10 g
41.0101	E	75 mm	20 mm	10 g
41.0110	B	90 mm	30 mm	11 g
41.0111	F	85 mm	30 mm	11 g
41.0115	C	105 mm	45 mm	12 g
41.0116	G	95 mm	45 mm	12 g
41.0120	D	125 mm	68 mm	12 g
41.0121	H	115 mm	68 mm	12 g



DEBAKEY
41.0130
12.5 cm



DEBAKEY
41.0132
12.5 cm



DEBAKEY
41.0134
12.5 cm 45°



DEBAKEY
41.0136
10 cm 90°



DEBAKEY
41.0138
12.5 cm



DEBAKEY-SATINSKY
41.0140 5,5 cm
41.0144 6,5 cm

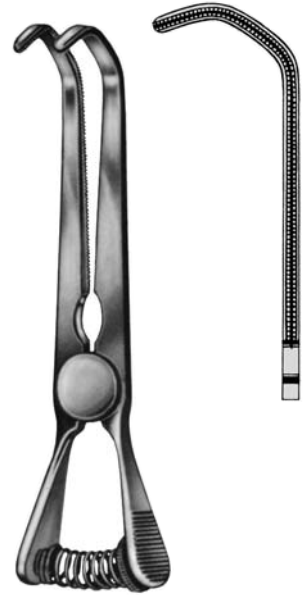

DEBAKEY-SATINSKY
41.0146 10 cm



DEBAKEY-CAROTID
41.0147 9 cm



41.0150
12 cm



14 cm

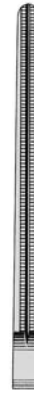

16 cm



18 cm

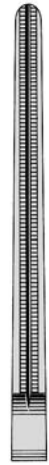

20 cm

DEBAKEY-PEAN

41.0160 14 cm

41.0162 16 cm

41.0164 18 cm

41.0166 20 cm

DEBAKEY-MOSQUITO

41.0150 12 cm



41.0151
12 cm



14 cm



16 cm



18 cm

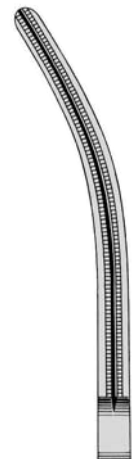

20 cm

DEBAKEY-PEAN

41.0161 14 cm

41.0163 16 cm

41.0165 18 cm

41.0167 20 cm

DEBAKEY-MOSQUITO

41.0151 12 cm

Coarctations- und Patent-Ductusklemmen
Coarctation and Patent Ductus Forceps
Pinces à coarctation et canal artériel
Pinzas para coartación y patente de conducto

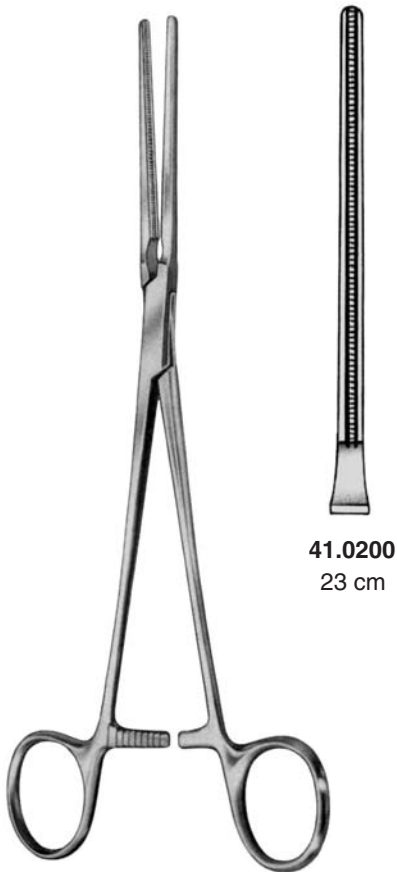

41.0200
23 cm

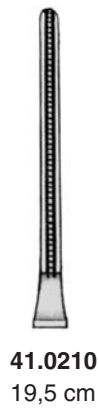

41.0210
19,5 cm

DEBAKEY



41.0203
23 cm

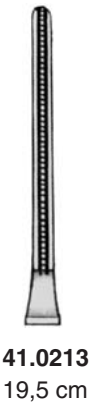

41.0213
19,5 cm

DEBAKEY

Peripheralklemmen
Peripheral Vascular Clamps
Pinces pour vaisseaux périphériques
Pinzas de conducto vascular



DEBAKEY
41.0235 18 cm

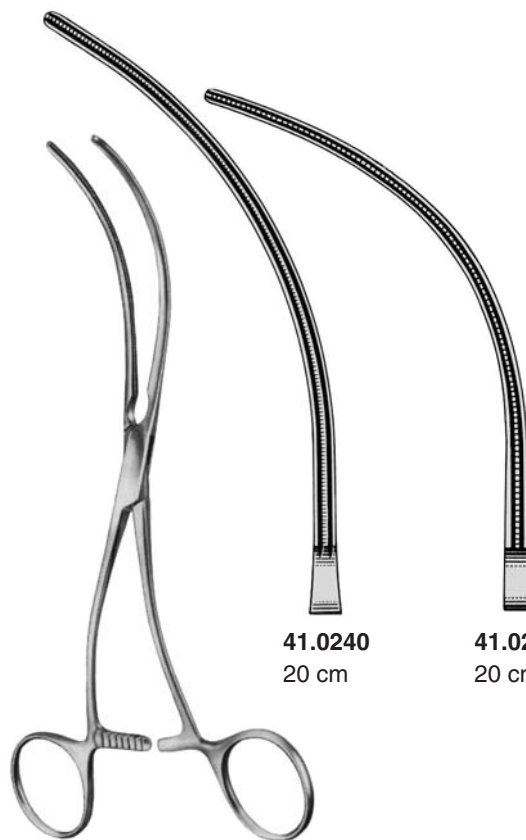

41.0240
20 cm

41.0245
20 cm

DEBAKEY



DEBAKEY
41.0250 15 cm



Mehrzweckklemmen
Multi-purpose Clamps
Pices-clamps universelles
Pinzas-Clamps de varias aplicaciones



41.0260
17 cm

41.0262
18,5 cm

DEBAKEY-BAINBRIDGE



41.0265
17 cm

41.0267
18,5 cm

DEBAKEY-BAINBRIDGE



DEBAKEY
41.0270
20 cm

Peripheralklemmen
Peripheral Vascular Forceps
Pinces pour vaisseaux périphériques
Pinzas para vasos periféricos



LELAND-JONES

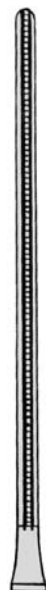

41.0290
19,5 cm

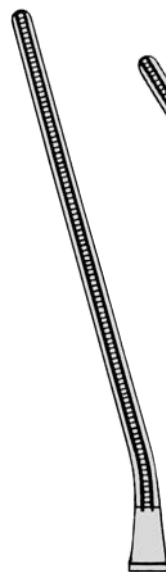

41.0291
19 cm 15°

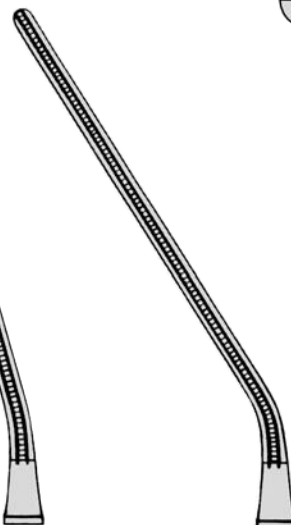

41.0292
19 cm 30°



DEBAKEY-OCHSNER
41.0317 23 cm

Aortaklemmen
Aortic Clamps
Pinces à l'aorte
Pinzas-clamps para aorta



DEBAKEY-DIETHRICH
41.0319 21 cm

Peripheralklemmen
 Peripheral Vascular Forceps
 Pincés pour vaisseaux périphériques
 Pinzas para vasos periféricos



DEBAKEY-DALE
 41.0340 18,5 cm

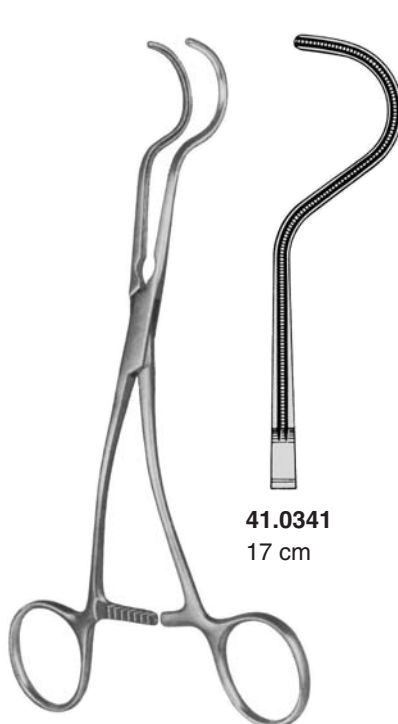

41.0341
 17 cm

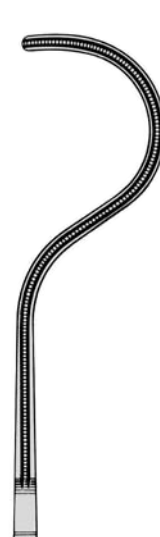

41.0342
 17,5 cm

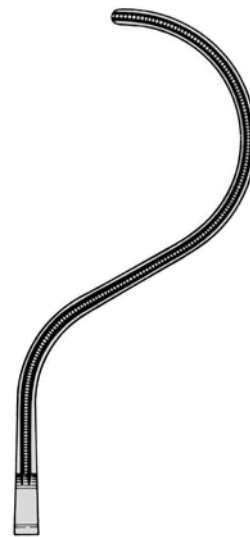

41.0343
 18,5 cm

DEBAKEY-DALE

Profundaklemmen
 Profunda Clamps
 Pincés-Clamps pour fémorale
 Pinzas de aneurisma aortica



DEBAKEY-GREGORY



41.0345
 14 cm

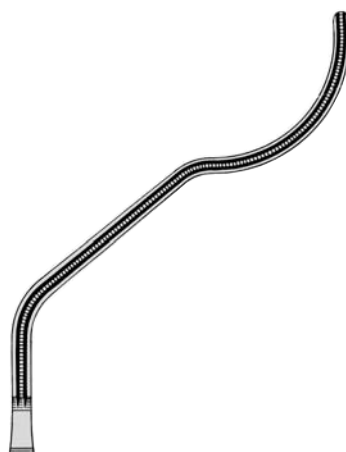

41.0346
 16 cm

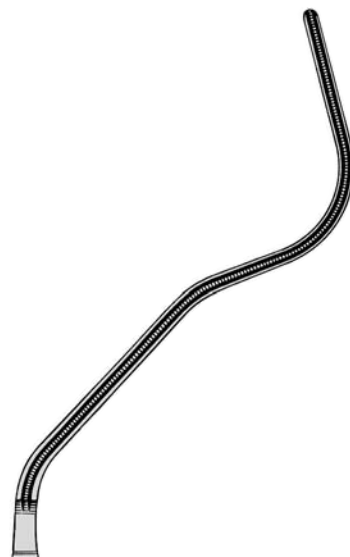

41.0347
 18 cm

Aorten-Aneurysmenklemmen
Aortic Aneurysm Clamps
Pinces pour aneurisme de l'aorte
Pinzas de aneurisma aortica



DEBAKEY

Aorten-Aneurysmenklemmen
Aortic Aneurysm Clamps
Pinces pour aneurisme de l'aorte
Pinzas de aneurisma aortica



DEBAKEY
41.0610 31,5 cm



DEBAKEY
41.0620 28 cm

Aortenklappen
Aortic Forceps
Pincers à l'aorte
Pinzas para aorta

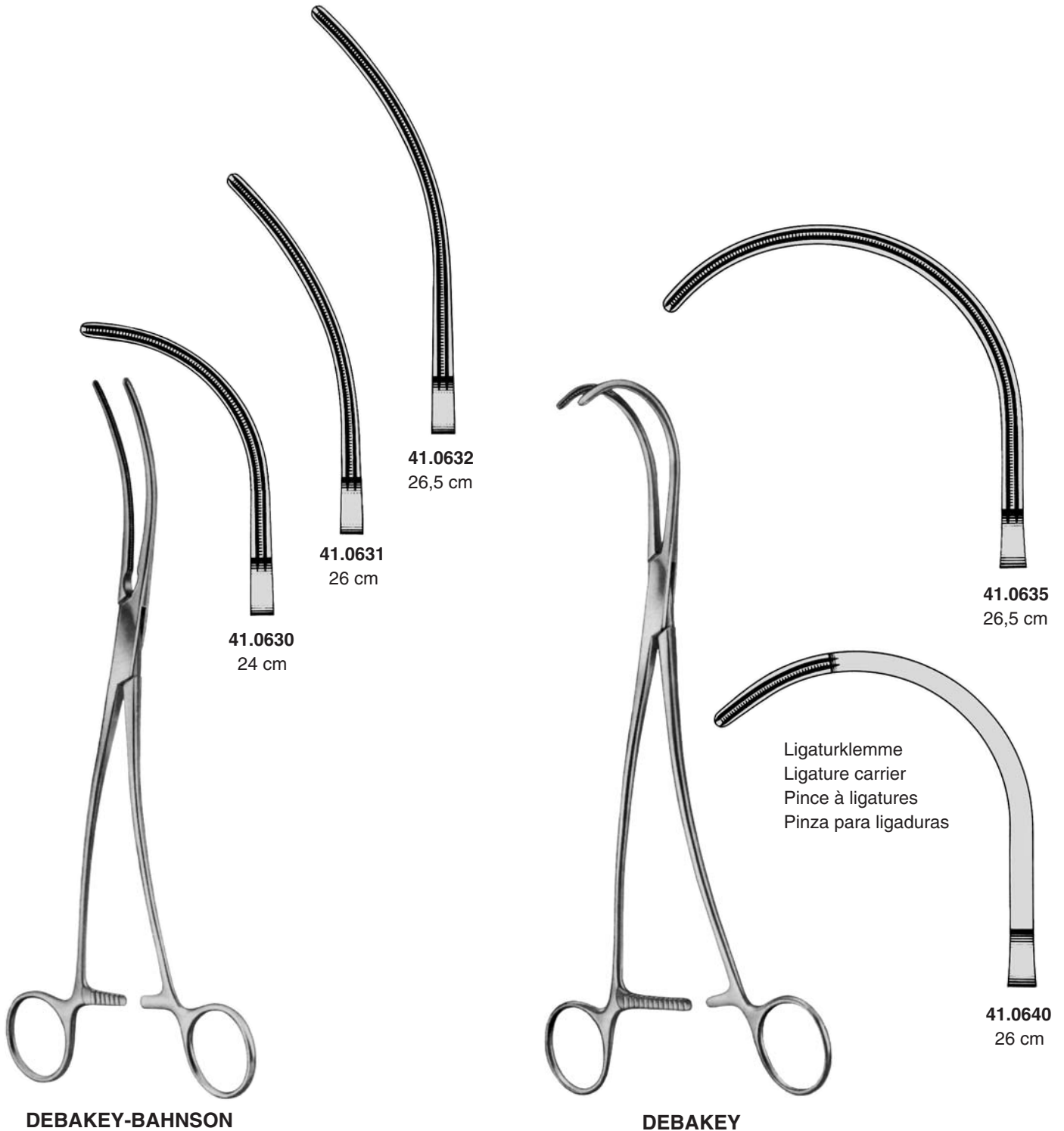

Aortenklammen
Aortic forceps
Pinces à l'aorte
Pinzas para aorta

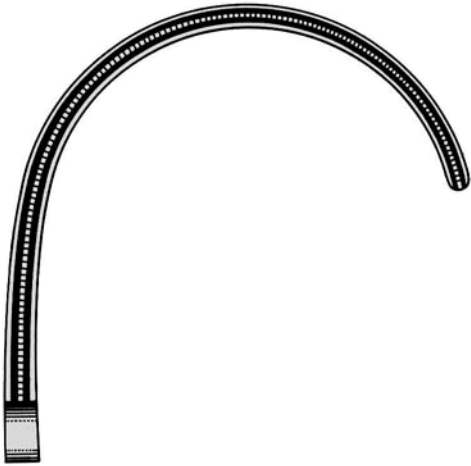

WEBER
41.0642 26 cm
links
left
à gauche
a izquierda



WEBER
41.0643 26 cm
rechts
right
à droite
a derecha

Aortenklappen
Aortic Forceps
Pinces à l'aorte
Pinzas para aorta



DIETHRICH
41.0645
21 cm

DEBAKEY
41.0650
26 cm



LEMOLE
20,5 cm

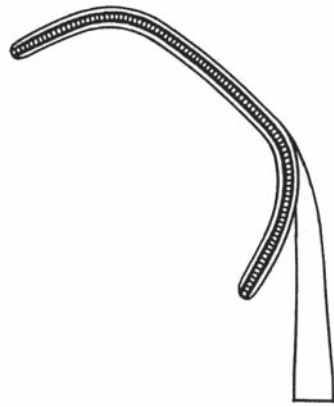

41.0651
4,1x1,6 cm
41.0653
4,5x2,3 cm

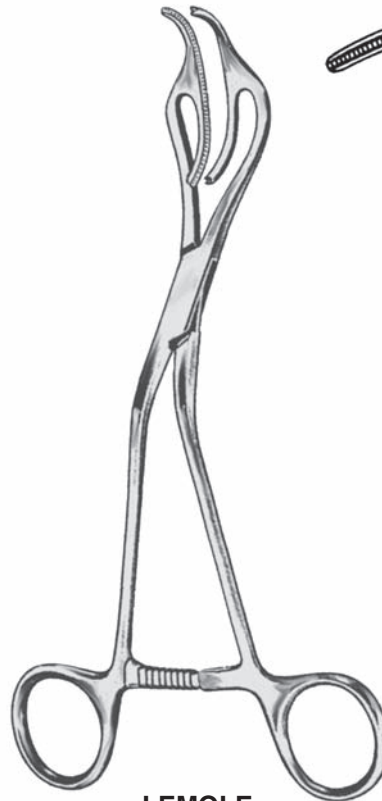

LEMOLE
20,5 cm

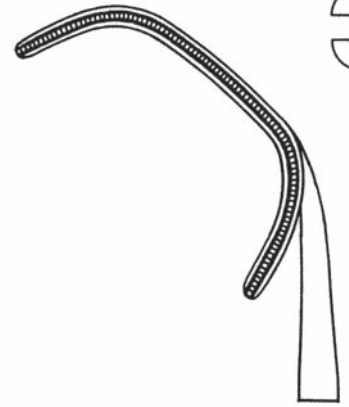

41.0652
4,1x1,6 cm
41.0654
4,5x2,3 cm



Aortenklammern
 Aortic Clamps
 Pinces à l'aorte
 Pinzas para aorta



WYLIE

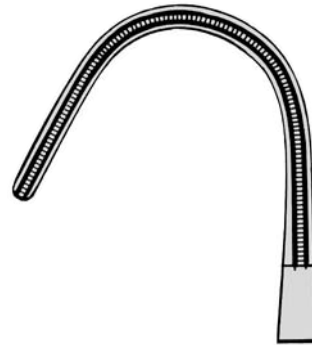

41.0655
23 cm

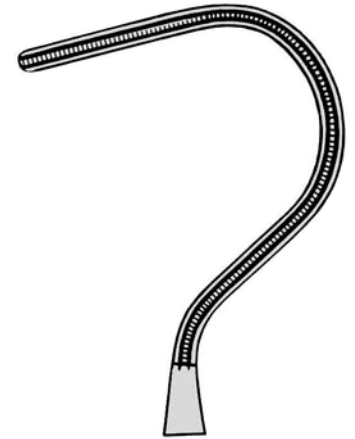

41.0656
22 cm



Aorta-Anastomosenklemmen
 Aortic Anastomosis Clamps
 Pinces pour anastomoses à l'aorte
 Pinzas para anastomosis de aorta

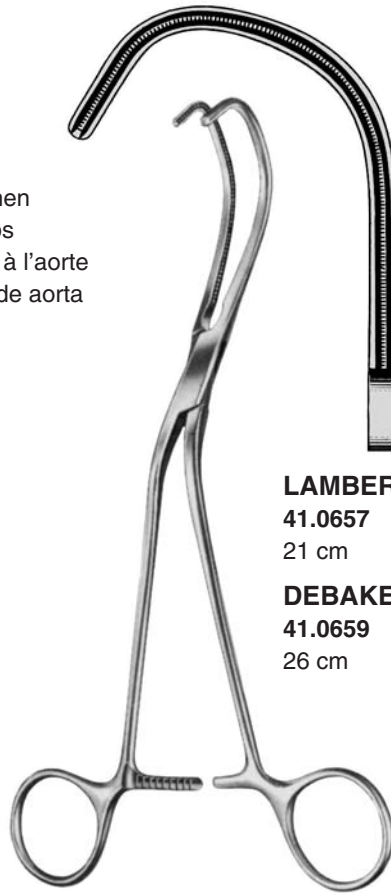

LAMBERT-KAY
 41.0657
 21 cm

DEBAKEY-LAMBERT
 41.0659
 26 cm



LAMBERT-KAY
 41.0658
 21 cm



SATINSKY

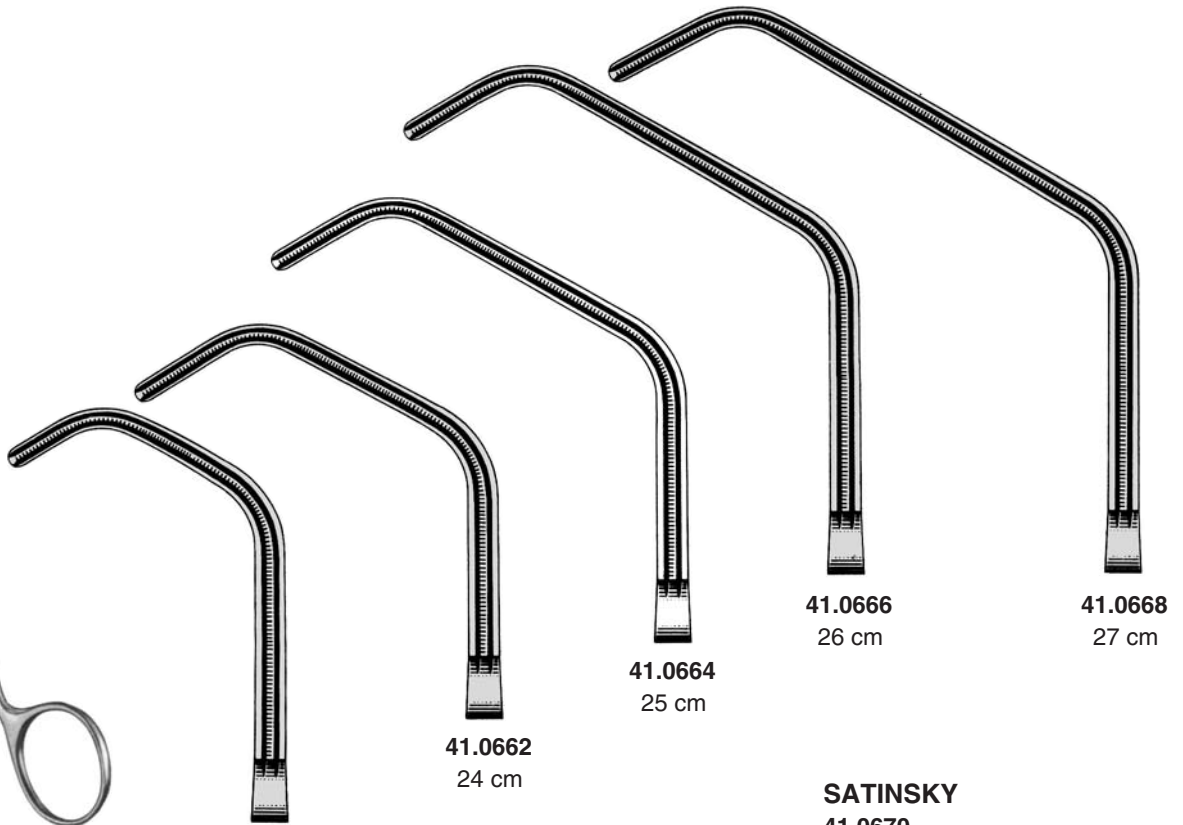

41.0660
 20 cm

41.0662
 24 cm

41.0664
 25 cm

41.0666
 26 cm

41.0668
 27 cm

Tangential-Verschlussklemmen
 Tangential occluding forceps
 Pinces pour occlusion tangentielle
 Pinzas para oclusión tangencial

SATINSKY
 41.0670

Satz 41.0660-41.0668
 Set 41.0660-41.0668
 Jeu 41.0660-41.0668
 Juego 41.0660-41.0668

Mehrzweckklemmen
 Multi Purpose Forceps
 Pincés pour application universelle
 Pinzas de multiple propósito

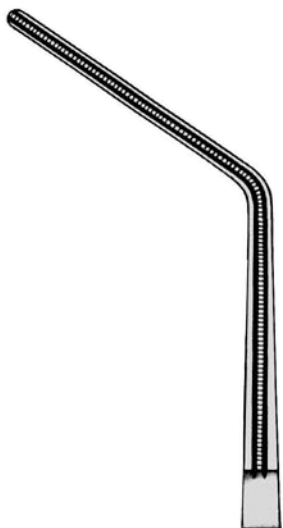

41.0680
25 cm 60°

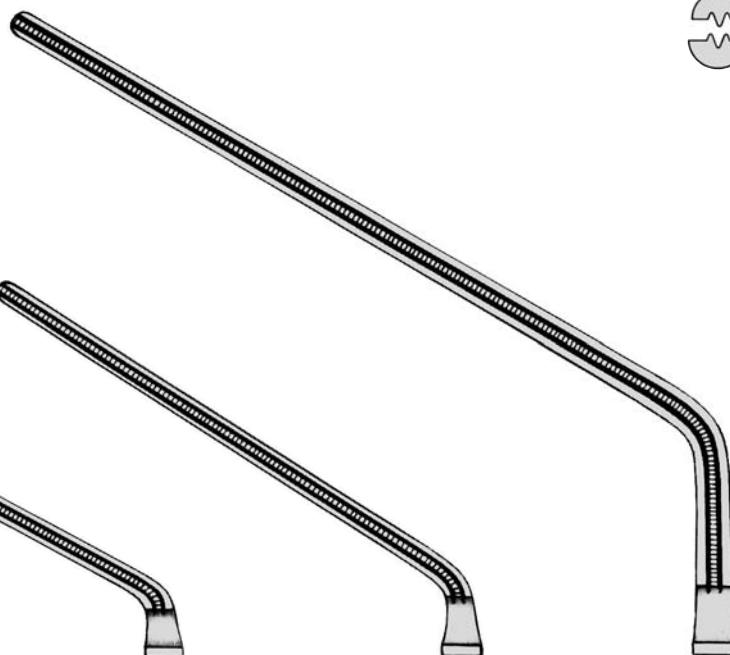

41.0686
31 cm 60°

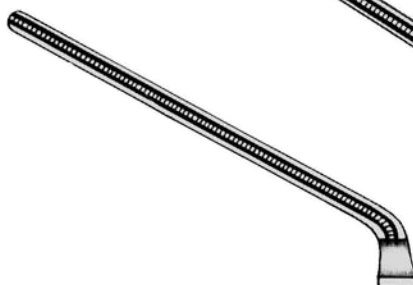

41.0682
21 cm 60°

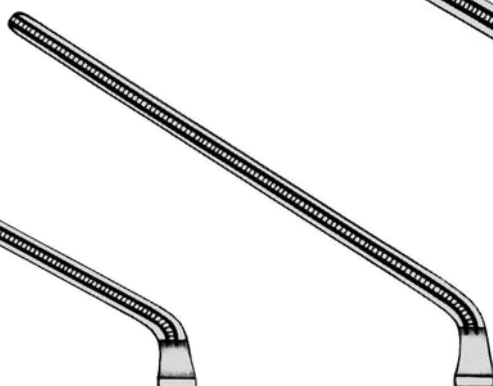

41.0684
24 cm 60°



DEBAKEY

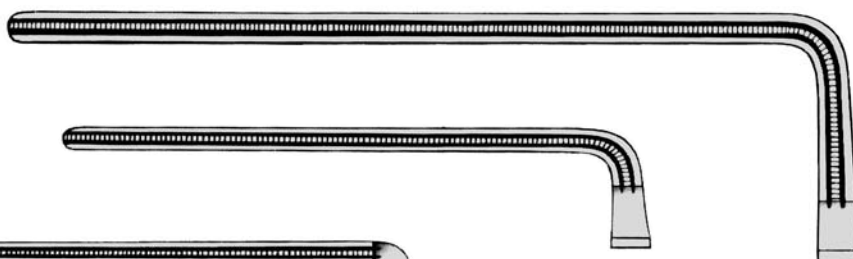

41.0696
28 cm 90°



41.0694
21 cm 90°



41.0692
18 cm 90°



41.0690
23 cm 90°

Aortenklammern
Aortic Forceps
Pincers à l'aorte
Pinzas para aorta

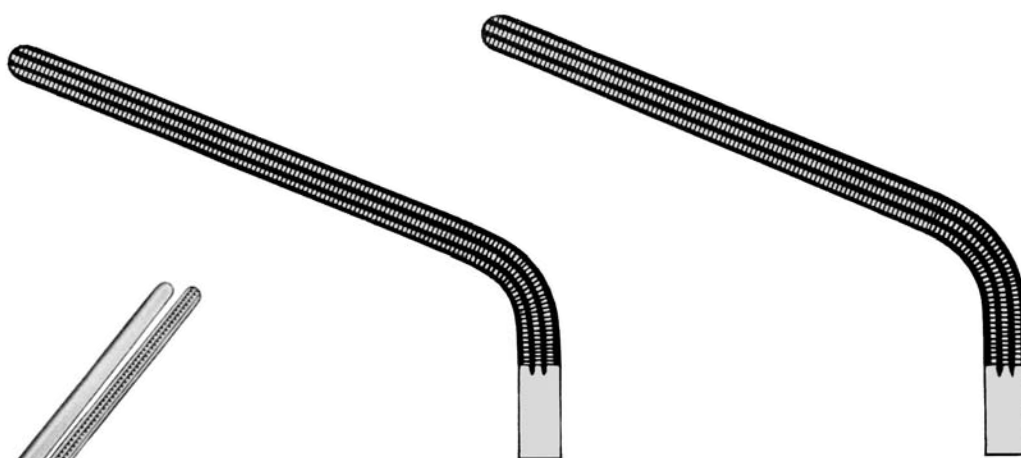

41.0700
20 cm

41.0701
26 cm



DEBAKEY-MORRIS

Vena cava-Klemmen
Vena Cava Clamps
Pinces pour veine cave
Pinzas para la vena cava



DEBAKEY-SATINSKY

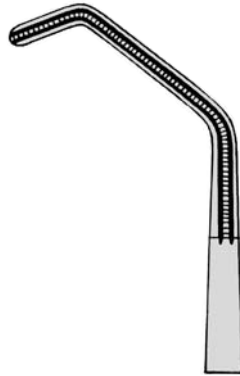

41.0825
23,5 cm

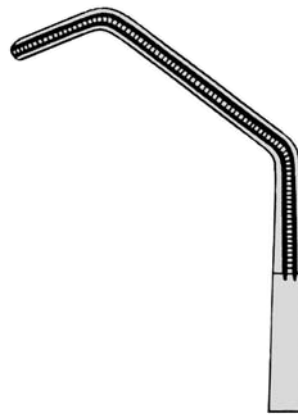

41.0826
24 cm

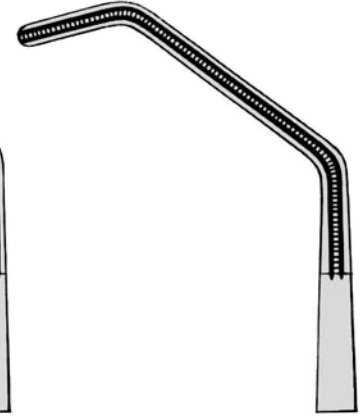

41.0827
24,5 cm

DEBAKEY-SATINSKY

41.0828

Klemmen Satz 41.0825-41.0827

Clamps Set 41.0825-41.0827

Jeu 41.0825-41.0827

Juego 41.0825-41.0827

Thorax- und Aurikelklemmen
Thorax and auricle Forceps
Pincés thoracique et à oreillette
Pinzas para tórax y aurícula



DEBAKEY-HARKEN
24 cm



41.0831
#1 25 cm



41.0832
#2 24 cm

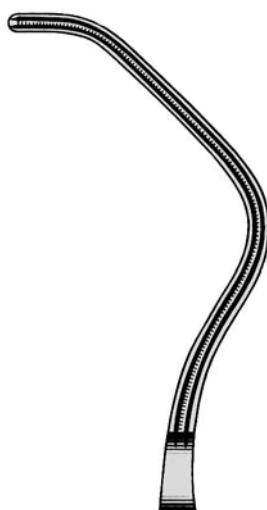

41.0833
#3 24 cm

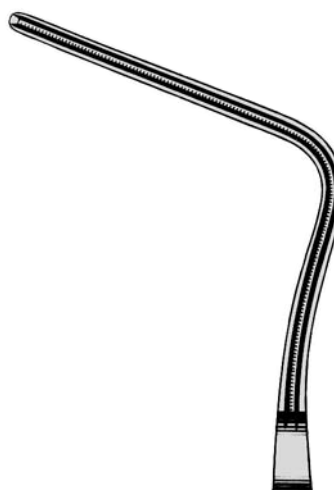

41.0834
#4 24 cm

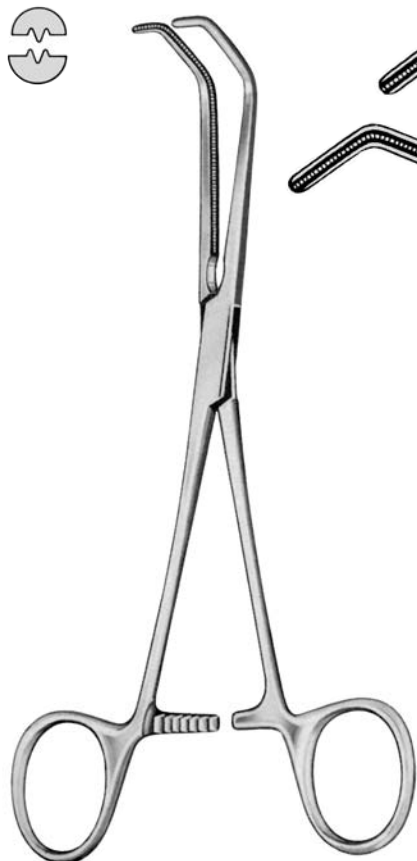

DEBAKEY-BECK

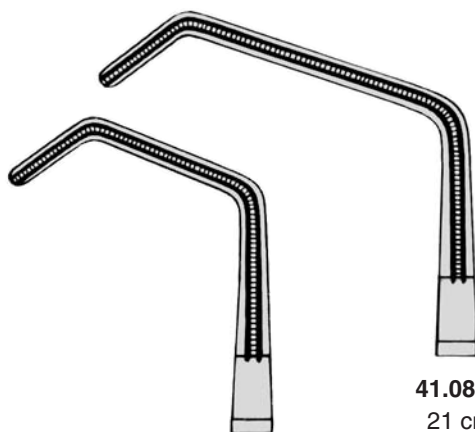

41.0886
19,5 cm

41.0887
21 cm

Aorten- und Koarctationsklemmen
 Aortic and Coarctation Forceps
 Pinces à l'aorte et à coarctation
 Pinzas para aorta y coartación

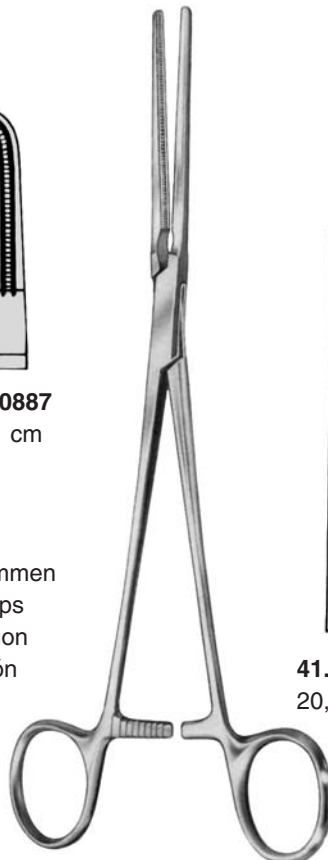

GLOVER



41.0910
20,5 cm



41.0915
22 cm



41.0917
26 cm



GLOVER



41.0911
20,5 cm

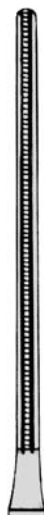

41.0916
22 cm



41.0918
25,5 cm



GLOVER



41.0912
21 cm



41.0913
22 cm

Patent-Ductusklemmen
 Patent Ductus Clamps
 Clamps patent-ductus
 Clamps patente de conducto

Anastomosenklemmen
Anastomosis Forceps
Pinces pour anastomoses
Pinzas para anastomosis



41.0930
21 cm

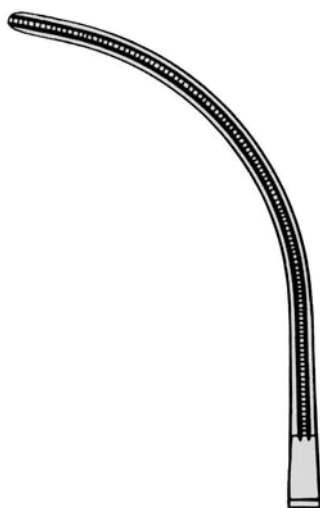

41.0932
24 cm

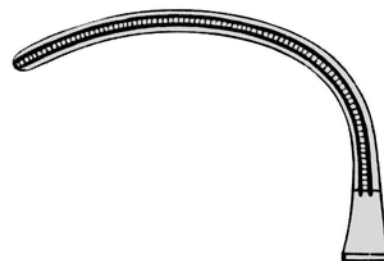

41.0940
18,5 cm



GLOVER

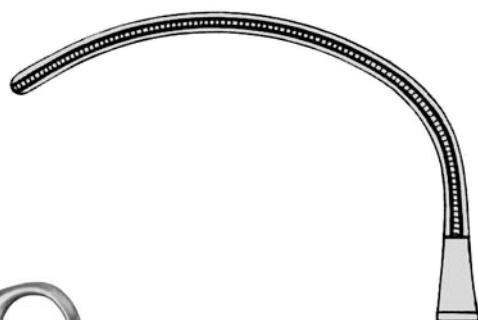

41.0942
22 cm



41.0945
21 cm



41.0947
26 cm



DEBAKEY



41.1160
21,5 cm



41.1162
23 cm



41.1164
27cm



41.1166
31,5 cm

Coarctationsklemmen
 Coarctation Forceps
 Pincés à coarctation
 Pinzas para coarctation



DEBAKEY



41.1161
21,5 cm



41.1163
23 cm



41.1165
27cm

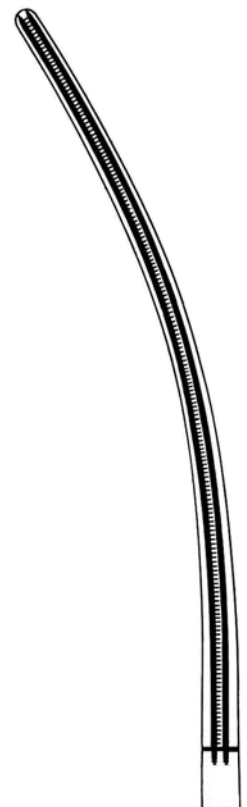

41.1167
31 cm



DEBAKEY



41.1360
19 cm



41.1363
23 cm

Thorax- und Präparierklemmen
Thoracic Dissecting Forceps
Dissecteurs pour chirurgie thoracique
Pinzas de disección torácica



LEES

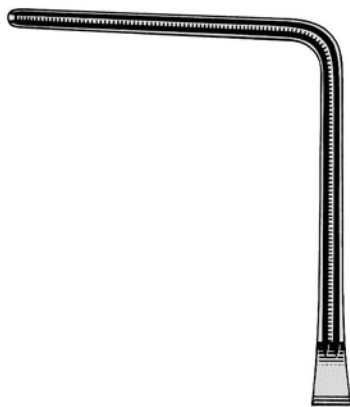

41.1370
23 cm 90°



LEES

41.1372
25 cm

Mehrweckklemmen
 Multi-Purpose Forceps
 Pincés pour application universelle
 Pinzas de multiple propósito



DEBAKEY
 41.1522 17 cm



DEBAKEY
 41.1523 16,5 cm

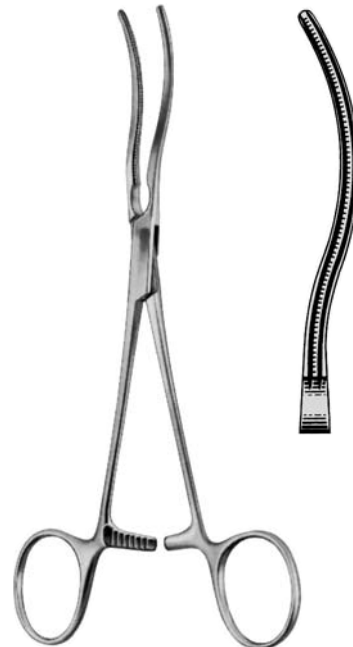

DEBAKEY-GLOVER
 41.1524 17 cm

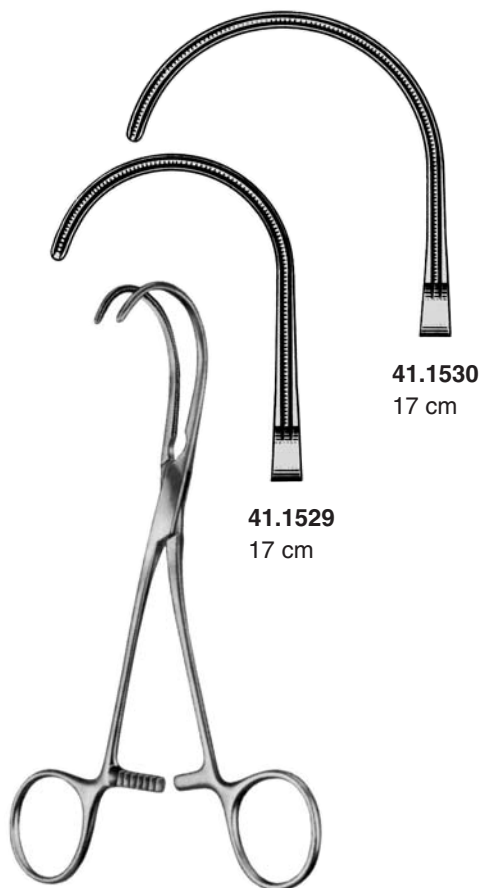

41.1529
 17 cm

41.1530
 17 cm

DEBAKEY

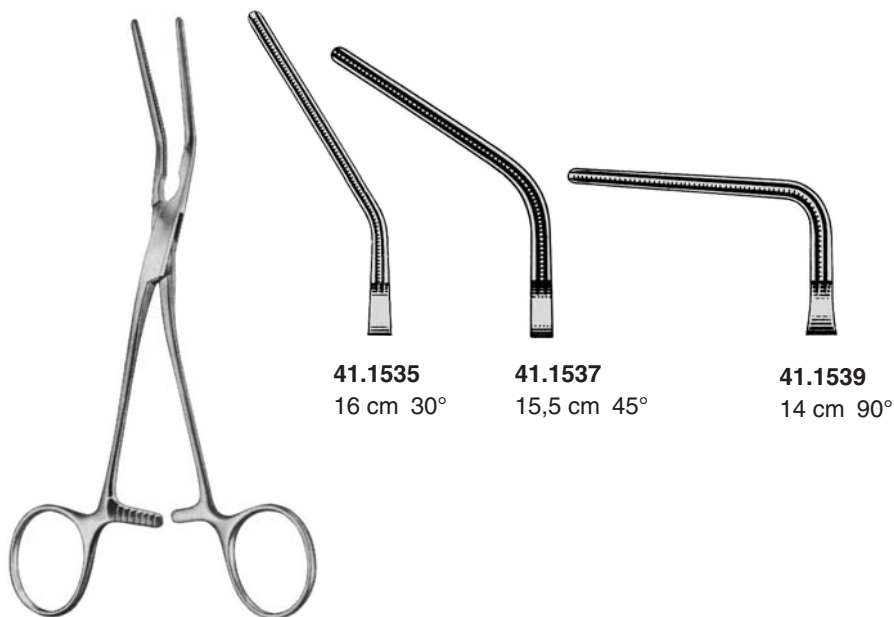

41.1535
 16 cm 30°

41.1537
 15,5 cm 45°

41.1539
 14 cm 90°

DEBAKEY

Anastomosenklemmen
Anastomosis Forceps
Pinces pour anastomoses
Pinzas para anastomosis



DEBAKEY-BECK
41.1550 16 cm



DEBAKEY-GLOVER
41.1555 17 cm

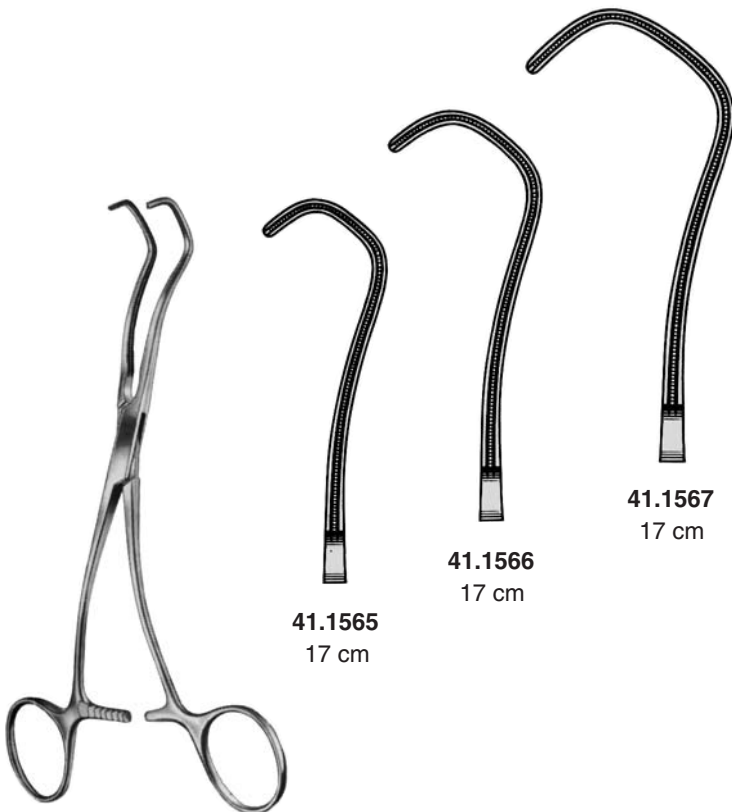

DEBAKEY-DERRA

41.1565
17 cm

41.1566
17 cm

41.1567
17 cm

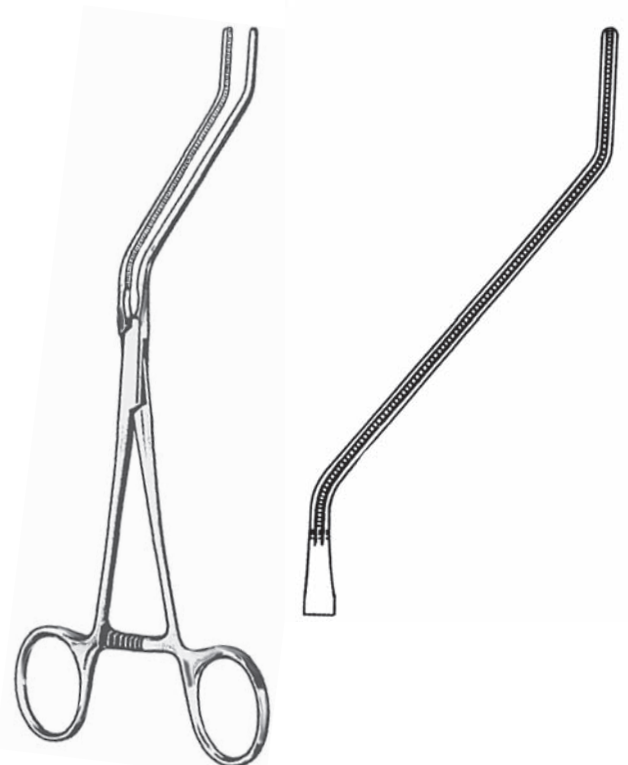

HENLY
41.1571
20 cm

Anastomosenklemmen
Anastomosis Forceps
Pinces pour anastomoses
Pinzas para anastomosis

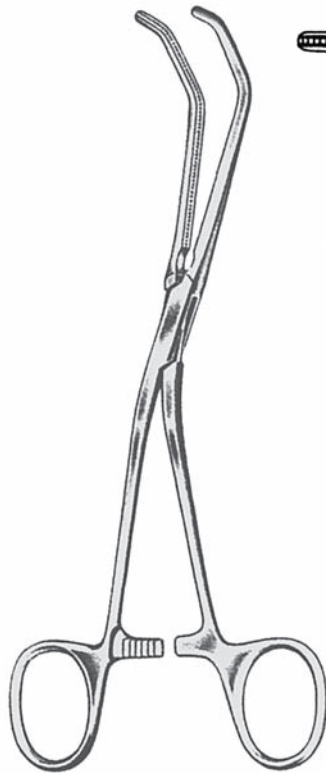

DEBAKEY-REYNOLDS

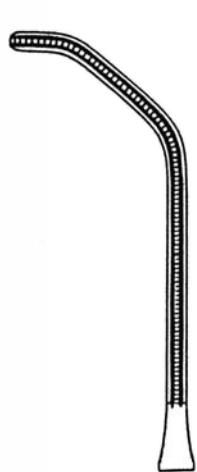

41.1580
18 cm

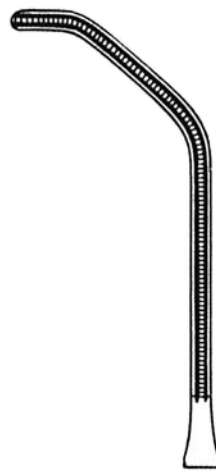

41.1581
18 cm



41.1585
16,5 cm

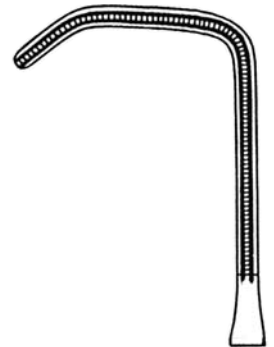

41.1586
16,5 cm



DEBAKEY-BECK

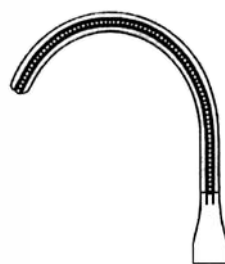

41.1590
15 cm



41.1591
15 cm

Unterbauchklemmen
Abdominal Clamps
Pinces abdominales
Pinzas abdominales



DEBAKEY
41.1593
17 cm

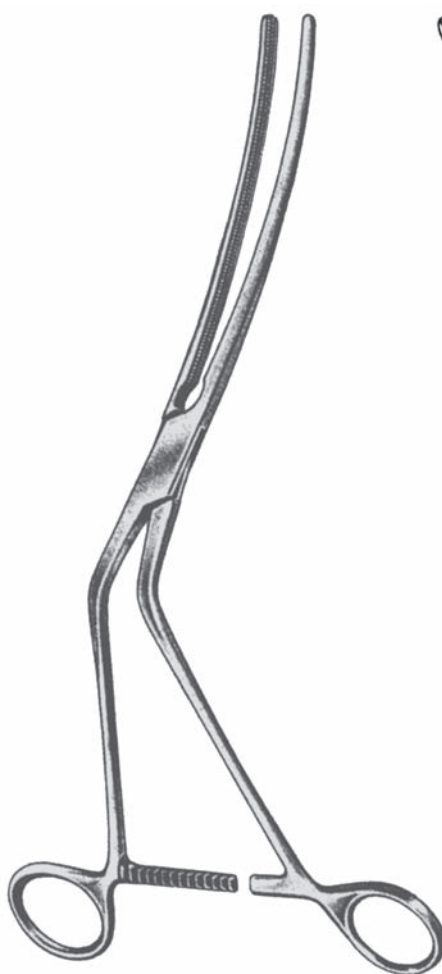

WYLIE

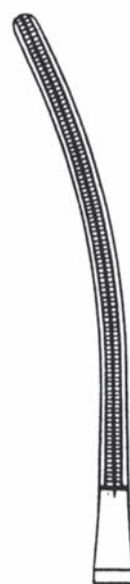

41.1657
27 cm

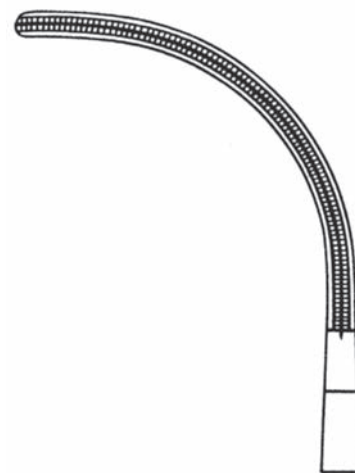

41.1658
26 cm

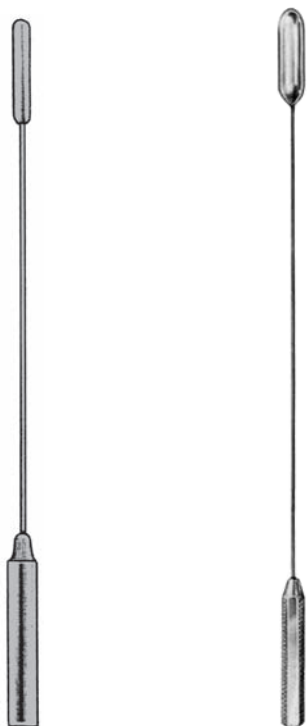

GARRETT
40.2800 -
40.2828

40.2810
14 cm /1,0-5,0 mm
Satz /Set/Jeu/Juego
40.2800-40.2808

40.2830
22 cm /1,0-5,0 mm
Satz /Set/Jeu/Juego
40.2820-40.2828

DEBAKEY
40.3000 -
40.3041

40.3012
19 cm /0,5-0,9 mm
Satz /Set/Jeu/Juego
40.3000-40.3011

40.3042
35 cm /0,5-0,9 mm
Satz /Set/Jeu/Juego
40.3030-40.3041

GARRETT 14 cm
22 cm

DEBAKEY 19 cm
35 cm

0,5 mm Ø	1,0 mm Ø	1,5 mm Ø	2,0 mm Ø
GARRETT 40.2800 40.2820	GARRETT 40.2801 40.2821	GARRETT 40.2802 40.2822	GARRETT 40.2803 40.2823
DEBAKEY 40.3000 40.3030	DEBAKEY 40.3001 40.3031	DEBAKEY 40.3002 40.3032	DEBAKEY 40.3003 40.3033

GARRETT 14 cm
22 cm

DEBAKEY 19 cm
35 cm

2,5 mm Ø	3,0 mm Ø	3,5 mm Ø	4,0 mm Ø
GARRETT 40.2803 40.2823	GARRETT 40.2804 40.2824	GARRETT 40.2805 40.2825	GARRETT 40.2806 40.2826
DEBAKEY 40.3004 40.3034	DEBAKEY 40.3005 40.3035	DEBAKEY 40.3006 40.3036	DEBAKEY 40.3007 40.3037

GARRETT 14 cm
22 cm

DEBAKEY 19 cm
35 cm

4,5 mm Ø	5,0 mm Ø	7,0 mm Ø	9,0 mm Ø
GARRETT 40.2807 40.2827	GARRETT 40.2808 40.2828	GARRETT 40.3009 40.3040	GARRETT 40.3010 40.3041
DEBAKEY 40.3008 40.3038	DEBAKEY 40.3009 40.3039	DEBAKEY 40.3010 40.3040	DEBAKEY 40.3011 40.3041



SCHMID

40.3103
3,0 mm Ø

40.3104
4,0 mm Ø

40.3105
5,0 mm Ø

40.3106
6,0 mm Ø

Spülkanülen – Irrigating Cannulae – Canules pour lavage – Canulas para irrigación

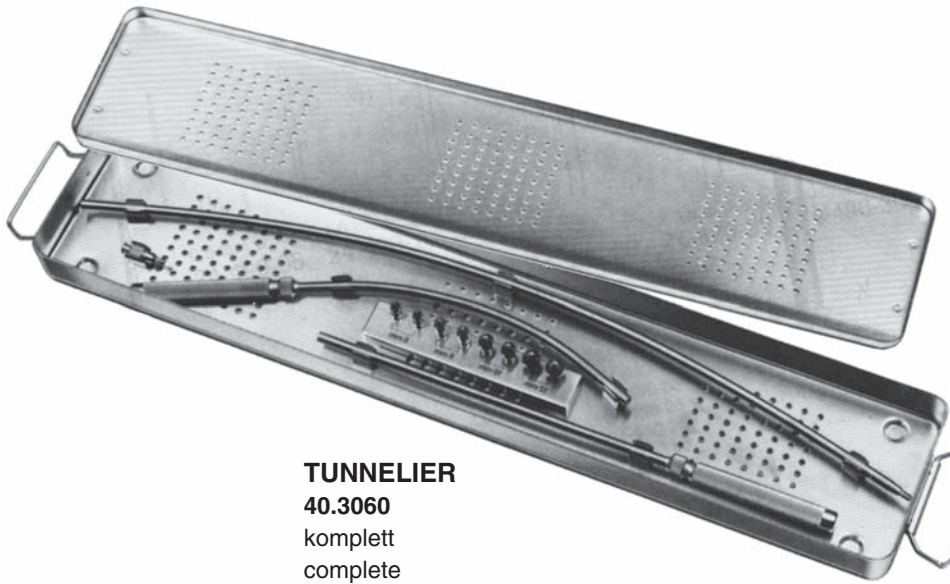

TUNNELIER
40.3060
 komplett
 complete
 complet
 completo

OLIVEN – OLIVES – OLIVES – OLIVAS
 (2 Stück – 2 pcs. – 2 pieces – 2 Piezas)



40.3066
 6 mm (2x)



40.3068
 8 mm (2x)



40.3069
 10 mm (2x)



40.3070
 12 mm (2x)



40.3071
 Venenaufsatz
 Vein tip
 Embout pour veines
 punta para venas



40.3072
 LUER-Adapter
 LUER-Adapter
 Adapteur LUER
 Adaptador LUER



40.3061
 2 Universal Tunnelier
 Griffe
 2 Universal handles
 2 Manches universaux
 2 mangos universales



40.3062
 225 mm
 Tunnelierschaft
 Tunneling shaft
 Tige pour tunneliser
 Vástago para tunelar



40.3063
 225 mm
 Tunnelierschaft
 Tunneling shaft
 Tige pour tunneliser
 Vástago para tunelar



40.3064
 540 mm
 Tunnelierschaft
 Tunneling shaft
 Tige pour tunneliser
 Vástago para tunelar

40.3075
 Halteplatte für Aufsätze
 Plate for tips
 Support pour embouts
 Soporte para puntas

40.3076
 Tunnelierset Sterilisierbehälter
 Sterilizing case
 Boîte pour stériliser
 Estuche para esterilizar

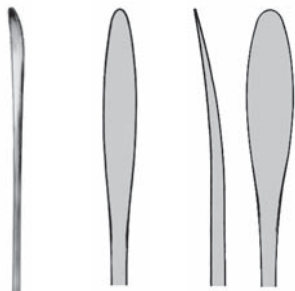

40.3150 14 cm
40.3152 23,5 cm

SCHMID

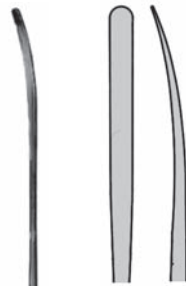

3 mm

40.3160 18,5 cm
40.3162 21,5 cm



40.3401 **40.3403** **40.3405**

LEMMON

17 cm



5 mm



4 mm

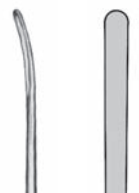

3 mm

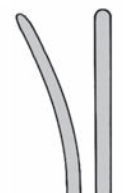

2 mm

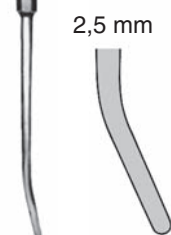

2,5 mm

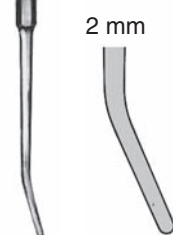

2 mm

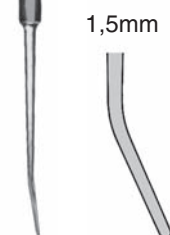

1,5mm



1 mm

ROBB
40.3410 24 cm

ROBB
40.3412 24 cm

ROBB
40.3414 24 cm

ROBB
40.3416 24 cm

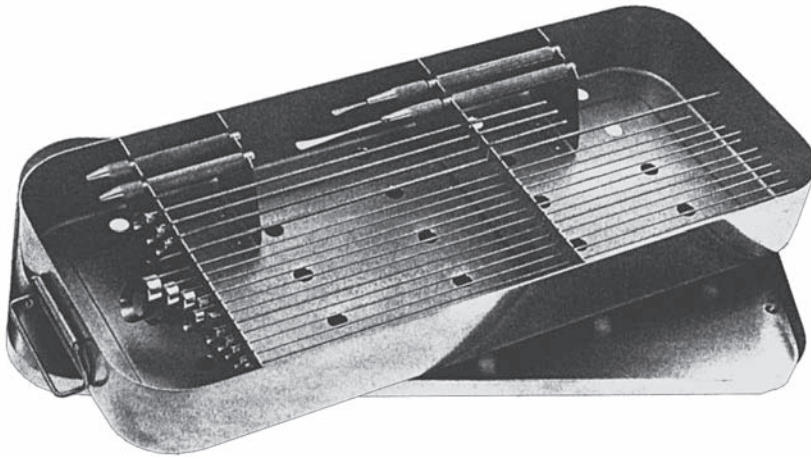

CANNON
40.4100

40.4100 Juego para endarterectomia, compuesto de:

- 1 Sonda para endarterectomia, oval, maleable ø 7,0x 7,8mm, 24cm
- 1 Sonda para endarterectomia, oval, maleable ø 8,0x 9,0mm, 24cm
- 1 Sonda para endarterectomia, oval, maleable ø 9,0x10,0mm, 24cm
- 1 Sonda para endarterectomia, oval, flexible ø 2,8x 3,1mm, 33cm
- 1 Sonda para endarterectomia, oval, flexible ø 3,9x 4,3mm, 33cm
- 1 Sonda para endarterectomia, oval, flexible ø 5,0x 5,7mm, 33cm
- 1 Sonda para endarterectomia, oval, flexible ø 6,0x 6,7mm, 33cm
- 1 Sonda para endarterectomia, oval, flexible ø 7,0x 8,0mm, 33cm
- 1 Sonda para endarterectomia, oval, flexible ø 7,8x 9,0mm, 33cm
- 1 Sonda para endarterectomia, oval, flexible ø 8,7x10,2mm, 33cm
- 1 Sonda para endarterectomia, oval, flexible ø 9,4x 10,8mm, 33cm
- 1 Sonda para endarterectomia, oval, flexible ø 15,5x17,3mm, 33cm
- 1 Sonda para endarterectomia, oval, flexible ø 18,0x10,5mm, 33cm
- 1 Sonda para endarterectomia, oval, flexible ø 22,2x23,2mm, 33cm
- 1 Instrumento conductor, flexible, 32 cm
- 1 Cuchillo para la intima, 4,7mm, 15 cm
- 1 Espátula para la intima, 5,6mm, 18 cm
- 2 Mangos para las sondas para endarterectomia, 8,5mm
- 1 Estuche para esterilizar 430x180x55mm

40.4100 Endarterectomie-Satz, bestehend aus:

- 1 Endarterektomiestripper, oval, biegsam ø 7,0x 7,8mm, 24cm
- 1 Endarterektomiestripper, oval, biegsam, ø 8,0x 9,0mm, 24cm
- 1 Endarterektomiestripper, oval, biegsam ø 9,0x10,0mm, 24cm
- 1 Endarterektomiestripper, oval, flexibel ø 2,8x 3,1mm, 33cm
- 1 Endarterektomiestripper, oval, flexibel ø 3,9x 4,3mm, 33cm
- 1 Endarterektomiestripper, oval, flexibel ø 5,0x 5,7mm, 33cm
- 1 Endarterektomiestripper, oval, flexibel ø 6,0x 6,7mm, 33cm
- 1 Endarterektomiestripper, oval, flexibel ø 7,0x 8,0mm, 33cm
- 1 Endarterektomiestripper, oval, flexibel ø 7,8x 9,0mm, 33cm
- 1 Endarterektomiestripper, oval, flexibel ø 8,7x10,2mm, 33cm
- 1 Endarterektomiestripper, oval, flexibel ø 9,4x 10,8mm, 33cm
- 1 Endarterektomiestripper, oval, flexibel ø 15,5x17,3mm, 33cm
- 1 Endarterektomiestripper, oval, flexibel ø 18,0x10,5mm, 33cm
- 1 Einführungsinstrument, flexibel, 32 cm
- 1 Intima-Messer, 4,7mm, 15 cm
- 1 Intima-Spatel, 5,6mm, 18 cm
- 2 Handgriffe für Endarterektomiestripper, 8,5mm
- 1 Sterilisier-Etui 430x180x55mm

40.4100 Endarterectomy-set, consisting of:









- 1 Endarterectomy stripper, oval, malleable ø 7,0x 7,8mm, 24cm
- 1 Endarterectomy stripper, oval, malleable, ø 8,0x 9,0mm, 24cm
- 1 Endarterectomy stripper, oval, malleable ø 9,0x10,0mm, 24cm
- 1 Endarterectomy stripper, oval, flexible ø 2,8x 3,1mm, 33cm
- 1 Endarterectomy stripper, oval, flexible ø 3,9x 4,3mm, 33cm
- 1 Endarterectomy stripper, oval, flexible ø 5,0x 5,7mm, 33cm
- 1 Endarterectomy stripper, oval, flexible ø 6,0x 6,7mm, 33cm
- 1 Endarterectomy stripper, oval, flexible ø 7,0x 8,0mm, 33cm
- 1 Endarterectomy stripper, oval, flexible ø 7,8x 9,0mm, 33cm
- 1 Endarterectomy stripper, oval, flexible ø 8,7x10,2mm, 33cm
- 1 Endarterectomy stripper, oval, flexible ø 9,4x 10,8mm, 33cm
- 1 Endarterectomy stripper, oval, flexible ø 15,5x17,3mm, 33cm
- 1 Endarterectomy stripper, oval, flexible ø 18,0x10,5mm, 33cm
- 1 Endarterectomy stripper, oval, flexible ø 22,2x23,2mm, 33cm
- 1 Introducing instrument, flexible, 32 cm
- 1 Intima knife, 4,7mm, 15 cm
- 1 Intima dissector, 5,6mm, 18 cm
- 2 Handles for Endarterectomy strippers, 8,5mm
- 1 Sterilizing case 430x180x55mm

40.4100 Jeu pour endartérectomie, composé de:

- 1 Stripper pour endartérectomie, ovales, malléable ø 7,0x 7,8mm, 24cm
- 1 Stripper pour endartérectomie, ovales, malléable ø 8,0x 9,0mm, 24cm
- 1 Stripper pour endartérectomie, ovales, malléable ø 9,0x10,0mm, 24cm
- 1 Stripper pour endartérectomie, ovales, flexibles ø 2,8x 3,1mm, 33cm
- 1 Stripper pour endartérectomie, ovales, flexibles ø 3,9x 4,3mm, 33cm
- 1 Stripper pour endartérectomie, ovales, flexibles ø 5,0x 5,7mm, 33cm
- 1 Stripper pour endartérectomie, ovales, flexibles ø 6,0x 6,7mm, 33cm
- 1 Stripper pour endartérectomie, ovales, flexibles ø 7,0x 8,0mm, 33cm
- 1 Stripper pour endartérectomie, ovales, flexibles ø 7,8x 9,0mm, 33cm
- 1 Stripper pour endartérectomie, ovales, flexibles ø 8,7x10,2mm, 33cm
- 1 Stripper pour endartérectomie, ovales, flexibles ø 9,4x 10,8mm, 33cm
- 1 Stripper pour endartérectomie, ovales, flexibles ø 15,5x17,3mm, 33cm
- 1 Stripper pour endartérectomie, ovales, flexibles ø 18,0x10,5mm, 33cm
- 1 Stripper pour endartérectomie, ovales, flexibles ø 22,2x23,2mm, 33cm
- 1 Instrument d'introduction, flexible, 32 cm
- 1 Couteau, 4,7mm, 15 cm
- 1 Spatule, 5,6mm, 18 cm
- 2 Manches pour stripper, 8,5mm
- 1 Boîte stérilisable 430x180x55mm



WALTON
 50 cm

- | | | | | |
|---|---|---|---|---|
|  |  |  |  |  |
| 40.4202
2 mm | 40.4203
3 mm | 40.4204
4 mm | 40.4206
5 mm | 40.4207
6 mm |
|  |  |  |  | |
| 40.4208
7 mm | 40.4210
8,5 mm | 40.4212
12 mm | 40.4214
14 mm | |



40.4219

- Griff für Ringstripper 40.4202-40.4214
- Handle for Ring strippers 40.4202-40.4214
- Manche pour strippers 40.4202-40.4214
- Mango para strippers 40.4202-40.4214



flexibel
flexible
flexible
flexibles

RUMEL-BELMONT

33 cm

40.3200

3,2 mm Ø

40.3201

3,2 mm Ø

Stilett alleine / stilette only / stilet seul / estilete suelto

40.3202

6,4 mm Ø

40.3203

6,4 mm Ø

Stilett alleine / stilette only / stilet seul / estilete suelto

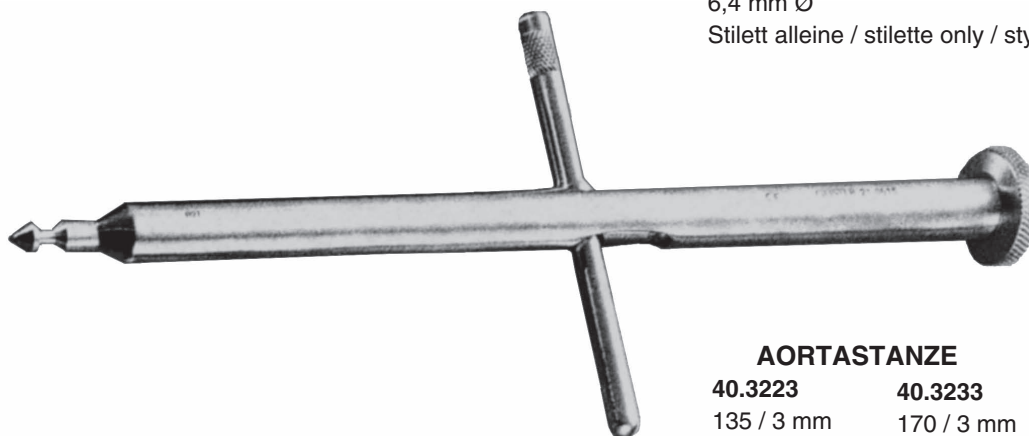

AORTASTANZE

40.3223

135 / 3 mm

40.3233

170 / 3 mm

40.3224

135 / 4 mm

40.3234

170 / 4 mm

40.3225

135 / 5 mm

40.3235

170 / 5 mm

40.3226

135 / 6 mm

40.3236

170 / 6 mm



40.3260

gerade
straight
droite
derecho



40.3266

90° abwärts
down
à bas
abajo



40.3262

25° abwärts
down
à bas
abajo



40.3268

45° links
left
à gauche
izquierda



40.3264

70° abwärts
down
à bas
abajo



40.3269

45° rechts
right
à droite
derecha



BAILEY

11,5 cm

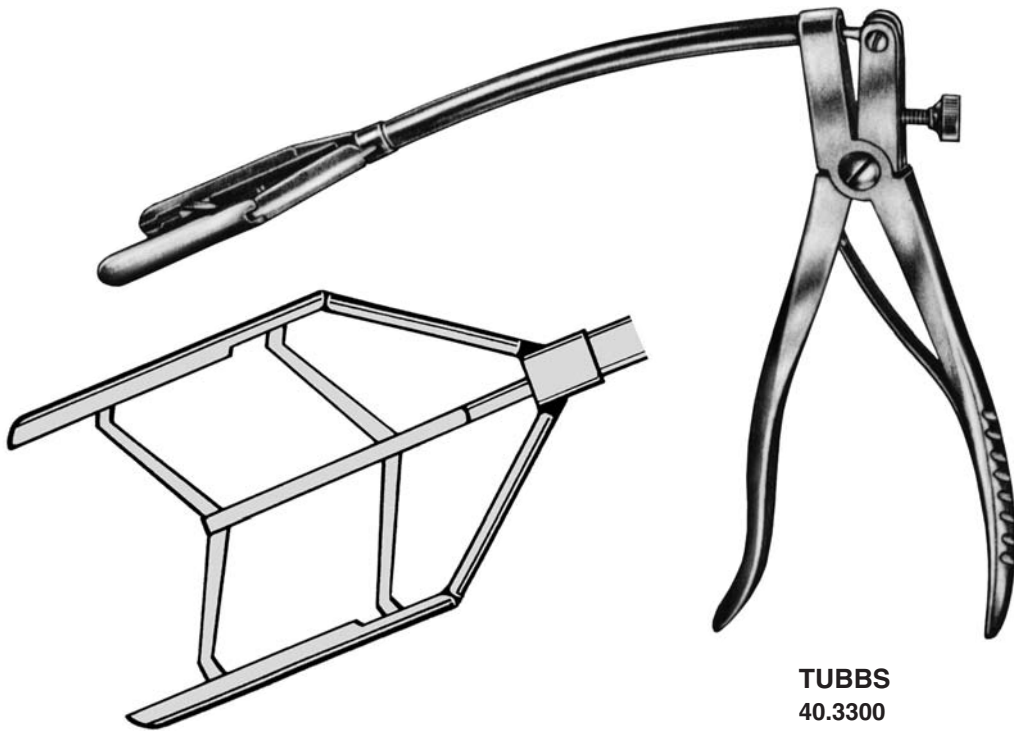

TUBBS
40.3300
8 - 42 mm

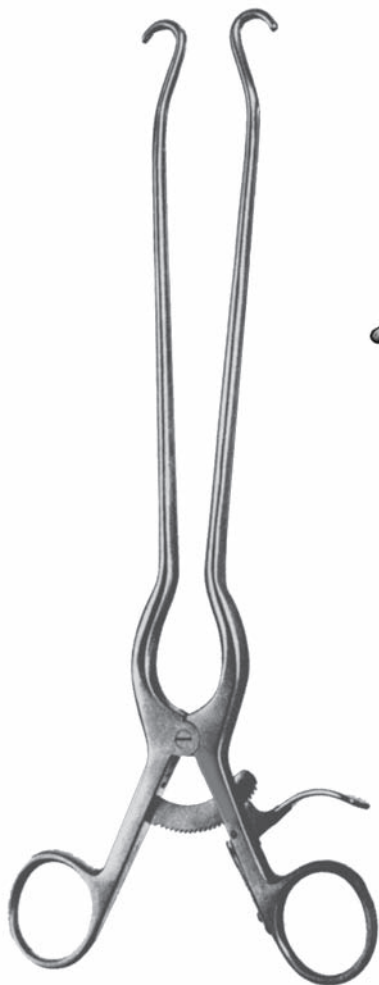

MORRIS
40.3400
26 cm

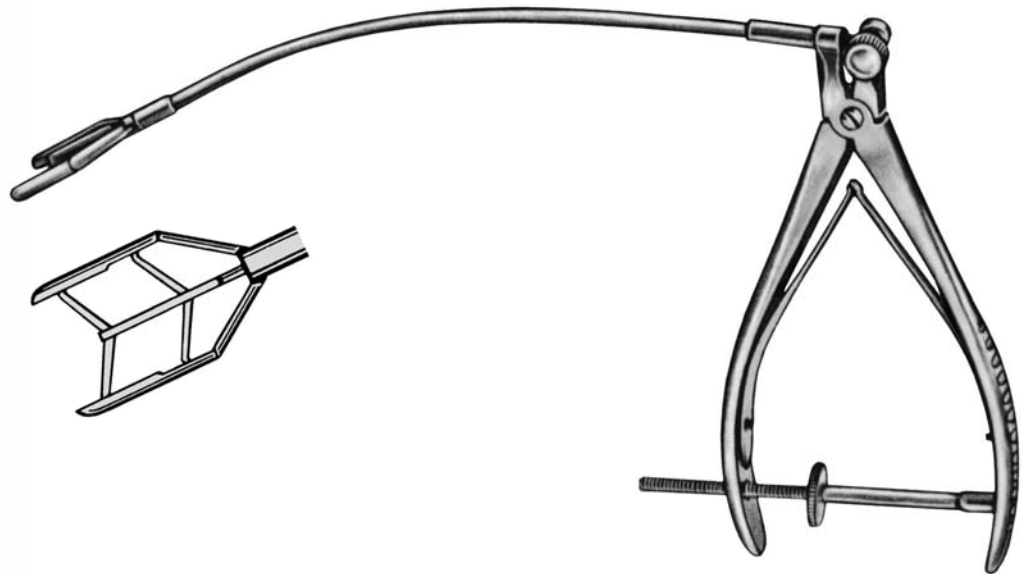

COOLEY
40.3312
8 - 42 mm

Gefäß-Wundspeizer
Vascular Retractor
Ecarteur vasculaire
Separador vascular



28.0600 16 cm
28.0602 18 cm
28.0604 20 cm
28.0606 22 cm
28.0608 24 cm

Spitzen 0,6 mm
 Tips 0,6 mm
 bout 0,6 mm
 punta 0,6 mm



28.0610 16 cm
28.0612 18 cm
28.0614 20 cm
28.0616 22 cm
28.0618 24 cm

Spitzen 0,9 mm
 Tips 0,9 mm
 bout 0,9 mm
 punta 0,9 mm



28.0622 18 cm

1 x 2 Zähne
 1 x 2 teeth
 1 x 2 dents
 1 x 2 dientes



28.2600 16,5 cm
28.2602 20,0 cm



28.2601 16,5 cm
28.2603 20,0 cm



28.2605 20,0 cm



28.2608 20,0 cm



28.2609 20,0 cm



28.2620 22,5 cm



28.2623 22,5 cm



28.2624 22,5 cm

28.2622 22,5 cm
 gezahnt
 serrated
 dentelées
 dentada

28.2625 24,5 cm



28.2628 22,5 cm



28.2629 22,5 cm



28.2640 22,5 cm



28.2641 22,5 cm

VANNAS

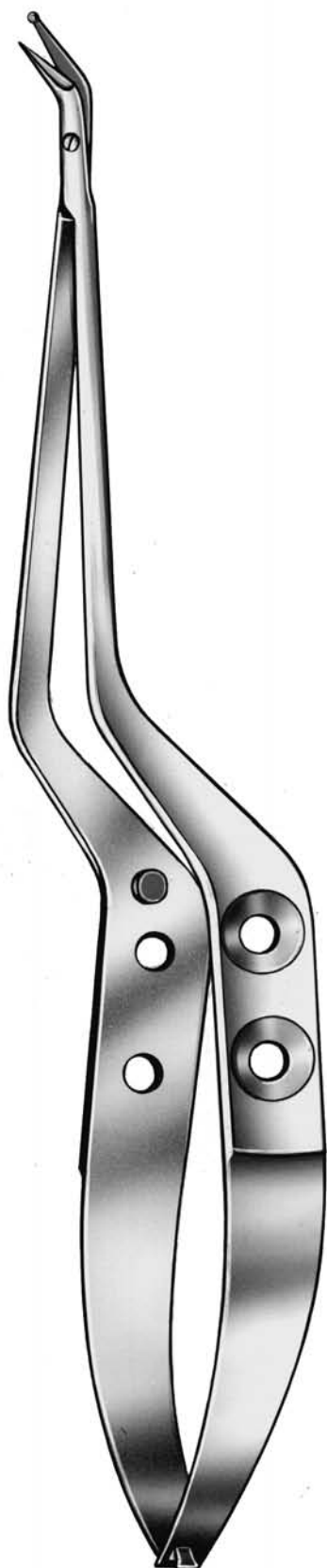

NAGEL



45°

28.2656 20,0 cm



45°

28.2657 20,0 cm

geknöpft
button-end
boutonée
abotonada



125°

28.2659 20,0 cm



28.3504 20,0 cm
28.3506 22,0 cm



28.3501 16,5 cm
28.3505 20,0 cm
28.3507 22,0 cm
28.3509 24,5 cm

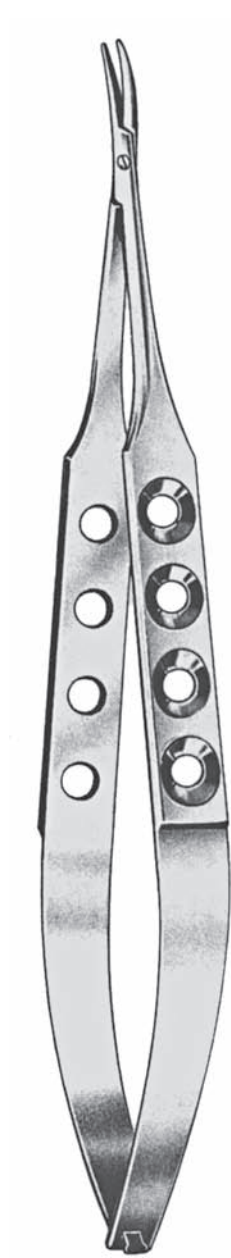

28.3520 16,0 cm
28.3522 18,0 cm















28.3521 16,0 cm
28.3523 18,0 cm

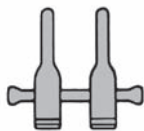
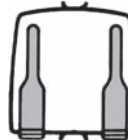
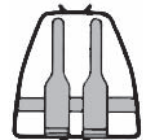

Anlegepinzette für Mikro-Gefäßklemmen 40.9286 bis 40.9419
Applying forceps for micro vascular clamps 40.9286 to 40.9419
Pince à poser les micro-clamps vasculaires 40.9286 à 40.9419
Pinzas para aplicar micro-clamps vasculares 40.9286 a 40.9419

40.9071
mit Sperre
with ratchet
avec verrou
con cierre

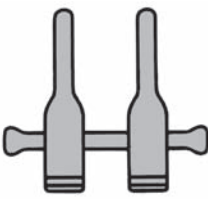
40.9072
ohne Sperre
without ratchet
sans verrou
sin cierre

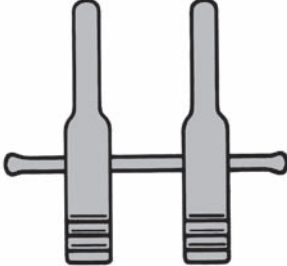
Gefäßgröße Vessel size Grandeur des vaisseaux Tamaño de vaso	Einzelklemmen (Paar) Single clamps (pair) Clamps individuels (paire) Clamps individuales (par)	Approximatoren ohne Rahmen, beweglich Approximators without frame, movable Approximateurs, sans cadre, mobiles Aproximadores sin cuadro, móviles	Doppelklemmen mit Rahmen Double clamps with frame Clamps doubles avec cadre Clamps dobles con cuadro	Approximatoren mit Rahmen, beweglich Approximators with frame, movable Approximateurs, avec cadre, mobiles Aproximadores con cuadro, móviles
0,4-1,0 mm				
ACLAND, mod.	40.9396V 40.9397A	40.9414V 40.9415A	40.9402V 40.9403A	40.9408V 40.9409A
0,6-1,5 mm				
ACLAND, mod.	40.9398V 40.9399A	40.9416V 40.9417A	40.9404V 40.9405A	40.9410V 40.9411A
1,0-2,25 mm				
ACLAND, mod.	40.9400V 40.9401A	40.9418V 40.9419A	40.9406V 40.9407A	40.9412V 40.9413A
1,5-3,5 mm				
ACLAND, mod.	40.9325V	40.9326V		
2,0-5,0 mm				
ACLAND, mod.	40.9286V	40.9287V		

V= für Venen
for veins
pour des veines
para venas

A= für Arterien
for arteries
pour des artères
para arterias

INHALTSVERZEICHNIS

A

Absaugrohre	89-90
COOLEY	90
DEBAKEY	89
NADREWPYNCHON	89
POOLE	89
YANKAUER	89
ACLAND Anlegepinzetten	185
ACLAND mod. Approximatoren	185
ACLAND mod. Approximatoren mit Rahmen	185
ACLAND mod. Doppelklemmen	185
ACLAND mod. Doppelklemmen mit Rahmen	185
ACLAND mod. Gefäßclips	185
ADSON anatomische Pinzetten	25,36
ADSON Arterienklemmen	49,50
ADSON chirurgische Pinzetten	28
ADSON-BABY Arterienklemmen	50
ADSON-BROWN Pinzetten PROMEDUR	37
ADSON-DEBAKEY Pinzetten	28
ADSON-GRAEFE Pinzetten	28
ADSON-MIKRO anatomische Pinzetten	25
ADSON-MIKRO chirurgische Pinzetten	28
ALDERDYCE Elevatorien	93
ALEXANDER Raspatorien	95
ALLIS Gewebefaßzangen	59
ALLIS Gewebefaßzangen ATRAUMATISCH	59
ALLIS-ADAIR Gewebefaßzangen	59
ALLIS-BABY Gewebefaßzangen	59
ALLISON Lungenspatel	72
ALLPORT Wundsperrer	79
ALM Wundsperrer	79
Anastomosenklemmen, atraumatisch	124,126,128,135,159,160,166,170,171,172
ANATOMIE Scheren	9
ANATOMIE Skalpelli	6
Anatomische Pinzetten	25-27
Anatomische Pinzetten ADSON	25
Anatomische Pinzetten BLANK	25
Anatomische Pinzetten BROPHY	25
Anatomische Pinzetten CUSHING	26
Anatomische Pinzetten DEBAKEY	34-35
Anatomische Pinzetten DEBAKEY-GERALD	26
Anatomische Pinzetten DUEHRSEN	26
Anatomische Pinzetten Feine	25
Anatomische Pinzetten GERALD	26,37
Anatomische Pinzetten GRAEFE	25
Anatomische Pinzetten McINDOE	25
Anatomische Pinzetten MIKRO	27,179
Anatomische Pinzetten POTTS-SMITH	26,36
Anatomische Pinzetten PROMEDUR	36,37
Anatomische Pinzetten WAUGH	26
ANDREW-PYNCHON Saugrohr	89
Anlegepinzetten für Acland Mikro-Gefäßklemmen	185
Anlegezange WICKHAM	143
ANLEGEZANGEN	45
für Micro-Clips	45
JOHN-HOPKINS	45
Anschlusskabel für bipolare Koagulationspinzetten	43
Aortahaken	76, 77
COOLEY	77
CRAWFORD	77
ROSS	108
Aortastanzen	76
BAILEY	177
Arterienklemmen	46-58
ADSON	49
ADSON-BABY	50
BABY-ADSON	50
BENGOLEA	50
BRIDGE	50
CRAFOORD	51

CRAFOORD-SELLORS	52
CRILE	48
DANDY	48
GEMINI	56
GEMINI-MINI	56
HALSTED	49
HARTMANN	46
HARTMANN-MICRO	46
HEISS	50
KANTROWITZ	56
KELLY	47,55
KOCHER	52
KOCHER-FINO	52
LERICHE	48
LOVELACE	48
MEEKER	57
MICRO-MOSQUITO	47
MIXTER-BABY	57
MIXTER-O'SHAUGHNESSY	54
MOSQUITO	46,47
OVERHOLT-BABY	54
OVERHOLT-GEISSENDOERFER	54
OVERHOLT-MIXTER	54
PEAN-FINO	51
PEAN-ROCHESTER	51
PROVIDENCE-HOSPITAL	47
RANKIN-CRILE	49
RANKIN-KELLY	48
ROBERTS	51
ROCHESTER-CARMALT	51
ROCHESTER-OCHSNER	53
ROCHESTER-PEAN	51
RUMEL	56
SAROT	52
WIKSTROEM	57
ZENKER	52
ARTERIOTOMIE Scheren mit Knopf	18
Atraumatische Gefäßklemmen	124-172
Aurikelhaken	77
CRAWFORD	77

B

BABCOCK Gewebefaßzangen	60
BABCOCK Gewebefaßzangen PROMEDUR	61
BABCOCK-DEBAKEY Gewebefaßzangen	61
BABY-ADSON Arterienklemmen	50
BABY-MIXTER Arterienklemmen	57
BABY-WEITLANER Wundsperrer	79
BAILEY Aortenstanzen	177
BAILEY Rippenkontraktoren	120
BAILEY-BABY Rippenkontraktoren	120
BAILEY-GIBBON Rippenkontraktoren	120
BARRAQUER Klingenthaler und brecher	7
BARRON Skalpelli	6
BEBAKEY-SATINSKY Tangential Verschlussklemmen	160
BECKMAN-WEITLANER Wundsperrer	80
BENGOLEA Arterienklemmen	50
BERRY STERNAL Nadelhalter PROMEDUR	82
BETHUNE Rippenscheren	107
BETHUNE-CORYLLOS Rippenscheren	107
BEYER Hohlmeisselzangen	101
Bipolare Koagulationspinzetten	38-42
BIPOL-Kabel für bipolare Koagulationspinzetten	43
BLANK antraumatische Pinzetten	25
BONNEY chirurgische Pinzetten PROMEDUR	37
BOWMAN Gefäßscheren	17
BOYS-ALLIS Gewebefaßzangen	60
BOZEMANN Nadelhalter PROMEDUR	83
BRIDGE Arterienklemmen	50
BROM Venenhaken	63
Bronchus und Lungenklemmen	122-123
BRONCHUS	122
FINOCCHIETTO	122

	Seite		Seite
HARRINGTON	122	COOLEY atraumatische Gefäßklemmen	124-135
LOVELACE	123	COOLEY atraumatische Gefäßpinzetten	35
PRICE-THOMAS	122	COOLEY atraumatische Gefäßpinzetten TITAN	35
Bronchusklemmen	122,123,168	COOLEY Coarctationsklemmen	127,130
FINOCHIETTO	122	COOLEY Dilatator für Mitralstenose	178
HARRINGTON	122	COOLEY Herzvorhofhaken	77
LEES	168	COOLEY Klemmen für Arterialiaca	127
PRICE-THOMAS	122	COOLEY Klemmen für TangentialVerschluß	127,132
SEMB	123	COOLEY Ligaturklemmen	128
BROPHY anatomische Pinzetten	25	COOLEY Mehrzweckklemmen atraumatisch	125,131,133,134,135
BROPHY chirurgische Pinzetten	29	COOLEY Neonatal und Kinderklemmen	124
BRUNNER Rippenscheren	108	COOLEY Nierenarterienklemmen	128
Bulldogclips	45-46	COOLEY Nierenstielklemmen	128
DIEFFENBACH	45	COOLEY Patent Ductusklemmen	127,130
JOHNHOPKINS	45	COOLEY Peripheralklemmen	131
SCHWARTZ	46	COOLEY Rippensperrerr	111
Bulldogklemmen atraumatisch	140-147	COOLEY Saugrohre	90
aus TITAN	144	COOLEY Vena Cava Verschlußklemmen	126,132
DEBAKEY	145,146	COOLEY-BABY Gefäßklemmen	138
DEBAKEY-MICRO	145	COOLEY-BECK Anastomosenklemmen	128
DIETRICH	142	COOLEY-DERRA Anastomosenklemmen	124
FEDERLEICHT	143	COOLEY-PARRY Anastomosenklemmen	135
GLOVER	140	COOLEY-SATINSKY Neonatal und Kinderklemmen	124
GREGORY	141	CORYLLOS-BETHUNE Rippenscheren	107
mit Ringgriff	146	CRAFOORD Arterienklemmen	51
SANTULLI	142	CRAFOORD Lungenscheren	17
WICKHAM	143	CRAFOORD-SELLORS Arterienklemmen	52
BURFORD Rippensperrerr ALUMINIUM	117	CRAWFORD Aurikelhaken	77
BURFORD-FINOCHIETTO Rippensperrerr ALUMINIUM	117	CRILE Arterienklemmen	48
		CRILE Arterienklemmen TITAN	48
		CRILE-BABY Arterienklemmen	48
		CRILE-RANKIN Arterienklemmen	49
		CRILE-WOOD Nadelhalter PROMEDUR	81
		CRILE-WOOD-BABY Nadelhalter PROMEDUR	81
		CUSHING anatomische Pinzetten	26
		CUSHING atraumatische Gefäßpinzetten PROMEDUR	36
		CUSHING chirurgische Pinzetten	30
		CUSHING Raspatorien	98
		CUSHING Venenhaken	64
C		D	
CANNON Endarterektomiestripper-Set	176	DANDY Arterienklemmen	48
CASTANEDA Neonatal Klemmen	137	DARDICK Mehrzweckklemmen	134
CASTANEDA Rippensperrerr ALUMINIUM	115	DAVIDSON Scapula-Haken	73
CASTROVIEJO Klinglehalter und -brecher	7	DAVIDSON-ALEXANDER Raspatorien	96
CASTROVIEJO Nadelhalter PROMEDUR	87	DE BOER Rippensperrerr	118
chirurgische Pinzetten	28-33,36,37	DEAVER Organspateln	70
ADLERKREUZ	31	DEBAKEY Absaugrohre	89
ADSON	28,36	DEBAKEY AortaExclusionsklemmen	150
ADSON-BROWN	31,37	DEBAKEY AortenAneurysmenklemmen	154,155
ADSON-DEBAKEY	28	DEBAKEY Aortenklemmen	156-159,165
ADSON-GRAEFE	28	DEBAKEY atraumatische Gefäßpinzetten	34-35,37
ADSON-MIKRO	28	DEBAKEY atraumatische Gefäßpinzetten TITAN	35
BONNEY	37	DEBAKEY Bulldogklemmen mit Ringgriff	146
BROPHY	29	DEBAKEY Coarctationsklemmen	149,165,166,167
BROWN	31	DEBAKEY Gefäß Scheren	19,24
CUSHING	30,36	DEBAKEY Gefäß Scheren PROMEDUR	24
DUEHRSEN	30	DEBAKEY Gefäßdilatoren	173
DURANTE	34	DEBAKEY Gewebe- und Organfaßzangen	58
feine chirurgische	28,29	DEBAKEY Ligaturklemmen	156
FERRIS-SMITH	29	DEBAKEY Ligaturklemmen	169
GERALD	37	DEBAKEY Mehrzweckklemmen	150,161,169
GILLIES	28	DEBAKEY Mikropinzetten	35
GRAEFE	28	DEBAKEY Mikropinzetten TITAN	35
LANE	32	DEBAKEY Nadelhalter PROMEDUR	82
LERCHE	31	DEBAKEY Nierenarterienklemmen	151
MAYO-RUSSIAN	32	DEBAKEY Patent Duktusklemmen	149,165
NELSON	31	DEBAKEY Peripheralklemmen	150,152,153
POTTS-SMITH	30	DEBAKEY Pinzetten PROMEDUR	37
RUSSIAN	32	DEBAKEY Präparierscheren	15
STILLE-BARRAYA	32	DEBAKEY Präparierscheren PROMEDUR	24
STONE	31	DEBAKEY Rippensperrerr für Erwachsene	110,118
WAUGH	33	DEBAKEY Rippensperrerr für Kinder	109
Chirurgische Scheren	10, 11		
DEAVER	10		
MIXTER	11		
COBB Elevatorien	93		
COLLIN Gewebefäßfasszangen	62		
COLLIN Skalpellgriffe	4		
COOLEY "XL" Rippensperrerr	111		
COOLEY Anastomosenklemmen	126,128,135		
COOLEY Aortenklemmen	133		
COOLEY atraumatische Bulldogklemmen	129		

	Seite		Seite
DEBAKEY Thorax-Präparierklemmen	168	Führungsnadeln	91
DEBAKEY-BAHNSON Aortenklappen	156		
DEBAKEY-BAINBRIDGE Gefäßklappen	151	G	
DEBAKEY-BECK Anastomosenklappen	171	GARRETT Gefäßdilatoren	173
DEBAKEY-BECK Aorten u. Koarktationsklappen	165	Gefäßklappen, atraumatisch	124-172
DEBAKEY-BECK Aortenklappen	170	Gefäßscheren	13,15,17-20,24
DEBAKEY-CAROTID Bulldogklappen	147	ARTERIOTOMIE	18
DEBAKEY-DALE Peripheralklappen	153	BOWMAN	17
DEBAKEY-DERRA Anastomosenklappen	170	DEBAKEY	19,24
DEBAKEY-DIETRICH Aortaklappen	152	FAVOLORO	19
DEBAKEY-GERALD atraumatische Pinzetten	26	HEGEMANN-DIETHRICH	18
DEBAKEY-GLOVER Coarctationsklappen	170	POTTS-DEMARTEL	20
DEBAKEY-GLOVER Gefäßklemme löffelförmig	169	POTTS-SMITH	18,19,24
DEBAKEY-GREGORY Profundaklappen	153	SATINSKY	13
DEBAKEY-HARKEN Thorax- und Aurikelklappen	164	VASCULAR	17
DEBAKEY-LAMBERT Aorta-Anastomosenklappen	160	DEMARTEL	20
DEBAKEY-MICRO Bulldogklappen	145	Gefäßscheren DURACUT	24
DEBAKEY-MORRIS Aortenklappen	162	Gefäßscheren geknüpft	17
DEBAKEY-MOSQUITO Arterienklappen	148	Gefäßsspateln	175
DEBAKEY-OCHSNER Aortaklappen	152	SCHMID	175
DEBAKEY-PEAN atraumatische Klappen	148	GEMINI Arterienklappen	56
DEBAKEY-REYNOLDS Anastomosenklappen	171	GEMINI-MINI Arterienklappen	56
DEBAKEY-SATINSKY Bulldogklappen	147	GERALD anatomische Pinzetten	26
DEBAKEY-SATINSKY Vena Cava Klappen	163	GERALD chirurgische Pinzetten	30
DEBAKEY-WERTHEIM Arterienklappen	58	GERALD chirurgische Pinzetten PROMEDUR	37
DEMARTEL Scheren	20	GERALD Pinzetten PROMEDUR	37
DICK Klemmzangen atraumatisch	58	Gewebefäßpinzetten	32,33
DIEFFENBACH Bulldogclips	45	COLLIN-DUVAL	33
DIETHRICH Aortenklappen	158	DUVAL	33
DIETHRICH Gefäß Scheren	18	SINGLEY (TUTTLE)	32
DIETHRICH Nadelhalter PROMEDUR	87	WAGNENSTEEN	32
DIETRICH Bulldogklappen	142	Gewebefäßzangen	58-62
DOYEN Rippen-Raspatorien	96	ALLIS-ADAIR	59
DUEHRSEN anatomische Pinzetten	26	ALLIS-BABY	59
DUEHRSEN chirurgische Pinzetten	30	BABCOCK	60-61
DUVAL Gewebefäßzangen	62	BABCOCK PROMEDUR	61
DUVAL Gewebefäßzangen ATRAUMATISCH	62	BABCOCK-DEBAKEY	61
DUVAL Gewebefäßzangen PROMEDUR	62	BABY-ALLIS	59
		BOYS-ALLIS	60
E		COLLIN	62
Elevatorien	93-94	DEBAKEY	58
ALDERDYCE	93	DEBAKEY-WERTHEIM	58
COBB	93	DICK	58
KEY	94	DUVAL	62
LANGENBECK	93	DUVAL-DEBAKEY	62
QUERVAIN	93	JUDD-ALLIS	60
Endarterektomiestripper	176	LOCKWOOD	60
		THOMS-ALLIS	60
F		WERTHEIM-DEBAKEY	58
FARABEUF Knochenhalteclips	99	WILLIAMS	60
FARABEUF Raspatorien	94	GILLIES chirurgische Pinzetten	28
FARABEUF-COLLIN Raspatorien	94	GILLIES chirurgische Pinzetten TITAN	28
FARABEUF-LAMBOTTE Knochenhalteclips	99	GILLIES Hauthäkchen	63
FAVALORO Wundsperrerr	121	GILLIES Nadelhalter PROMEDUR	86
FAVALORO-OCHSNER Wundsperrerr	121	GIL-VERNET Wundhaken	65
FEDERLEICHT Bulldogklappen	143	GLOVER atraumatische Bulldogklappen	140
Feine chirurgische Scheren	8,21	GLOVER Coarctationsklappen	165
für Linkshänder	8	GLUCK Rippenklappen	106
mit grossen Ringen	8	GOELET Wundhaken	65
WALKER	8	GOLDMAN-FOX chirurgische Scheren PROMEDUR	21
PROMEDUR	21	GORNEY Präparierscheren	20
SUPERCUT	8,9	GRAEFE feine anatomische Pinzetten	25
FERGUSON Knochenhalteclips	99	GRAEFE feine chirurgische Pinzetten	28
FERRIS-SMITH chirurgische Pinzetten	29	GREEN Wundhaken	68
FINOCHIETTO Bronchusklappen	122	GREGORY atraumatische Bulldogklappen	141
FINOCHIETTO Nadelhalter PROMEDUR	82		
FINOCHIETTO Rippenklappen	112,116	H	
FINOCHIETTO Rippenklappen ALUMINIUM	116	HABERER Organspateln	69
FINOCHIETTO-BABY-HAIGHT Rippenklappen	112,113	HALSTED Arterienklappen	49
FINOCHIETTO-MODIF. Rippenklappen	113	Halteplatte für Tunnelierzubehör	174
Fistelscheren	11	HARRINGTON Bronchusklappen	122
KELLY	11	HARRINGTON Wundhaken	71

	Seite		Seite
HARTMANN Arterienklemmen	46	KOCHER-GRAZIL Arterienklemmen	52
HARTMANN Ligaturklemme	46	KÖNIG Wundhaken	64
HARTMANN-MIKRO Klemmen	46	Krampfaderbesteck NABATOFF	92
HEANEY Nadelhalter PROMEDUR	84		
HEGEMANN Gefäßscheren	18		
HEISS Arterienklemmen	50		
HENLY Anastomosenklemmen	170		
Herzvorhofhaken	77		
Hohlmeisselzangen	101-103		
BEYER	101		
MARQUARDT	101		
MAYFIELD	101		
RUSKIN	101		
SAUERBRUCH	103		
SMITH-PETERSEN	102		
STILLE	102		
STILLE-LUER	102		
STILLE-RUSKIN	102		
ZAUFAL-JANSEN	101		
I			
Inhaltsverzeichnis			
Intima Dissektoren	175		
LEMMON	175		
Intima Spateln	175		
ROBB	175		
INTRACARDIAC Nadelhalter PROMEDUR	87		
J			
JAMESON Präparierscheren	16		
JAVID Karotisklemmen	131		
JOHN-HOPKINS Anlegezange	45		
JOHN-HOPKINS Bulldogclips	45		
JUDD-ALLIS Gewebefäßzangen	60		
JULIAN Nadelhalter PROMEDUR	82		
K			
KADER Organspateln	69		
KANTROWITZ Arterienklemmen	56		
Karotisklemmen	131		
KELLY Arterienklemmen	47,55		
KELLY Arterienklemmen TITAN	47		
KELLY Fistelscheren	11		
KELLY Fistelscheren SUPERCUT	11		
KELLY-RANKIN Arterienklemmen	48		
KEY Raspatorien	94		
KILNER Nadelhalter PROMEDUR	81		
Kinderklemmen	124,136-139,		
KIRKLIN Venenhäkchen biegsam	63		
KIRMISSION Raspatorien	94		
KLAPP Sehnenscheidenhaken	64		
KLINGENBERG-LOTH Präparierscheren	13		
Klingenhalter und brecher	7		
BARRAQUER	7		
CASTROVIEJO	7		
TROUTMAN	7		
Knochenhalte-zangen	99-100		
FARABEU	99		
FARABEU-LAMBOTTE	99		
FERGUSSON	99		
LANGENBECK	99		
SEMB	99		
ULRICH	100		
Knochensplitterzangen	104-105		
RUSKINLISTON	104		
STILLE-HORSLEY	105		
STILLE-LISTON	104		
Koagulations-Pinzetten bipolar	38-42		
KOCHER Arterienklemmen	52		
KOCHER Wundhaken	66,67		
L			
LAHEY-METZENBAUM Präparierscheren	15		
LAMBERT-KAY Aorta-Anastomosenklemmen	160		
LAMBOTTE Raspatorien	95		
LANGENBECK Elevatorien	93		
LANGENBECK Knochenhalte-zangen	99		
LANGENBECK Nadelhalter PROMEDUR	84		
LANGENBECK Raspatorien	94		
LEBSCHKE Rippenscheren	108		
LEBSCHKE Sternummeißel	108		
LEES Bronchusklemmen	168		
LELAND-JONES Peripheralklemmen	152		
LEMMON Intima Dissektoren	175		
LEMMON Rippenkontraktoren	120		
LEMOLE Aortaklemmen	159		
LERICHE Arterienklemmen	48		
LEXER-BABY Präparierscheren	15,21		
LICHTENBERG Nadelhalter PROMEDUR	85		
Ligaturklemmen	122,128,156		
COOLEY	128		
DEBAKEY	156		
SEMB	123		
LOCKWOOD Gewebefäßzangen	60		
LOVELACE Arterienklemmen	48		
LOVELACE Lungenklemme 20cm geb	12		
LOVELACE Lungenklemmen	123		
Lungenspateln	72,73,75		
ALLISON	72		
DAVIDSON	73		
POLLOSON	75,75		
M			
MARQUARDT Hohlmeisselzangen	101		
MASSON Nadelhalter PROMEDUR	83		
MATHIEU Nadelhalter PROMEDUR	8		
MATHIEU-KOCHER Nadelhalter PROMEDUR	85		
MATSON Raspatorien	97		
MATSON-ALEXANDER Rippenraspatorien	95		
MAYFIELD Hohlmeisselzangen	101		
MAYO Präparierscheren	12,22		
MAYO Präparierscheren PROMEDUR	22		
MAYO-HARRINGTON Präparierscheren PROMEDUR	22		
MAYO-HEGAR Nadelhalter PROMEDUR	81		
MAYO-LEXER Präparierscheren PROMEDUR	22		
MAYO-STILLE Präparierscheren	12,22		
McINDOE anatomische Pinzetten	25		
MEEKER Arterienklemmen	57		
MERCEDES Rippensperr	119		
METZENBAUM Präparierscheren	14,23		
METZENBAUM-BABY Präparierscheren	13		
METZENBAUM-X-FINO Präparierscheren	14,23		
MIDDELDORPF Wundhaken	67,68		
Mikro Clips	45		
Mikro Nadelhalter mit Profilgriff	184		
Mikro Pinzetten	27-35,179		
Mikro Pinzetten mit Profilgriff	179		
Mikro Scheren mit Profilgriff	180-182		
Mikroclip Anlegezangen	45		
MIKRO-MOSQUITO Arterienklemmen	47		
Mikro-Präparierscheren mit Profilgriff	180		
Mikroscheren	180-182		
Mikro-Präparier mit Profilgriff	180		
NAGEL	182		
VANNAS	181		
Mikro-Skalpellklingen	6		
MIKROVASCULAR Nadelhalter	82		
MINI-Bulldog Clips	46		

MIXTER Arterienklemmen	57
MIXTER chirurgische Scheren	11
MIXTER-BABY Arterienklemmen	57
MIXTER-O'SHAUGHNESSY Arterienklemmen	54
MOBERG Wundhaken	63
MORRIS Gefäßwundspreizer	178
MORSE Wundhaken	66
MORSE-COOLEY Rippensperrerr	112
MORSE-FAVALORO Rippensperrerr	114
MORSE-STERNAL Rippensperrerr	114
MOSQUITO Arterienklemmen	47
MOSQUITO Arterienklemmen für LINKSHÄNDER	46

N

NABATOFF Krampfader-Besteck	92
Nadelhalter	81-87,183-184
BABY-CRILE-WOOD	81
BERRY	82
BOZEMANN	83
CASTROVIEJO	87
CRILEWOOD	81
CRILEWOOD-BABY	81
DEBAKEY	82
DIETHRICH	87
FINOCHIETTO	82
GILLIES	86
HEANEY	84
INTRACARDIAC	87
JULIAN	82
KILNER	81
LANGENBECK	84
LICHTENBERG	85
MASSON	83
MATHIEU	85
MATHIEU-KOCHER	85
MAYO-HEGAR	81
MICRO	183,184
MICROVASCULAR	82
MINI-RYDER	86
NEIVERT	81
OLSEN-HEGAR	86
RYDER	86
RYDER-MINI	86
SAROT	84
STRATTE	84
WANGENSTEEN	83
NAGEL Mikro-Scheren mit Profilgriff	182
NEIVERT Nadelhalter PROMEDUR	81
NEONATAL-Kinderklemmen	136-139
Neonataalklemmen	124,136-139

O

OEHLER chirurgische Pinzetten PROMEDUR	37
OLSEN-HEGAR Nadelhalter PROMEDUR	86
Organspateln	69-71
ALLISON	72
DAVIDSON	73
DEAVER	70
HABERER	69
HARRINGTON	71
KADER	69
POLLOSON	74,75
REVERDIN	69
TUFFIER	69
OVERHOLT Raspatorien	97
OVERHOLT-BABY Arterienklemme	54
OVERHOLT-GEISSENDOERFER Arterienklemmen	54
OVERHOLT-MIXTER Arterienklemmen	54

P

PEAN-FINO Arterienklemmen	51
Pinzetten anatomisch	25-27
ADSON	25
BLANK	25
BROPHY	25
CUSHING	26
DEBAKEY	34-35
DEBAKEY-GERALD	26
DUEHRSSSEN	26
Feine	25
GERALD	26,37
GRAEFE	25
McINDOE	25
MIKRO	27,179
POTTS-SMITH	26,36
PROMEDUR	36,37
WAUGH	26
FINO	25
PROMEDUR	36,37
TITAN	25,26
Pinzetten chirurgisch	28-33,36,37
ADLERKREUZ	31
ADSON	28,36
ADSON-BROWN	31,37
ADSON-DEBAKEY	28
ADSON-GRAEFE	28
ADSON-MIKRO	28
BONNEY	37
BROPHY	29
BROWN	31
CUSHING	30,36
DUEHRSSSEN	30
DURANTE	34
feine chirurgische	28,29
FERRIS-SMITH	29
GERALD	37
GILLIES	28
LANE	32
LERCHE	31
MAYO-RUSSIAN	32
NELSON	31
POTTS-SMITH	30
RUSSIAN	32
STILLE-BARRAYA	32
STONE	31
WAUGH	33
Pinzetten chirurgische FINO	29
POLLOSON Wundhaken	74,75
POOLE Absaugrohre	89
POTTS Gefäßsscheren	10
POTTS Patent-Ductusklemmen	165
POTTS-DEMARTEL Gefäß Scheren	20
POTTS-SMITH chirurgische Pinzetten	30
POTTS-SMITH anatomische Pinzetten PROMEDUR	36
POTTS-SMITH anatomische Pinzetten TITAN	26
POTTS-SMITH Gefäß Scheren	18,19,24
POTTS-SMITH Gefäß Scheren PROMEDUR	24
POTTS-SMITH Gefäß Scheren SUPERCUT	18
Präparierscheren	10,13-15,22,23
DEBAKEY	15
GORNEY	20
JAMESON	16
KLINGENBERG-LOTH	13
LAHEY-METZENBAUM	15
LEXER-BABY	15
MAYO	12,22
MAYO-STILLE	12,22
METZENBAUM	14,23
METZENBAUM-BABY	13
POTTS	10
REYNOLDS	16
THOREK (HALLE)	13
TOENNIS	15

	Seite		Seite
TOENNIS-ADSON	15,22	BAILEY-GIBBON	120
Mikro	180	LEMMON	120
PRÄPARIER-Scheren mit Profilgriff	180	SELLORS	120
PRICE-THOMAS Bronchusklemmen	122	ROBB Intima Spateln	175
PROMEDUR Scheren	21-24	ROBERTS Arterienklemmen	51
PROVIDENCE-HOSPITAL Arterienklemmen	47	ROCHESTER-CARMALT Arterienklemmen	51
		ROCHESTER-OCHSNER Arterienklemmen	53
		ROCHESTER-PEAN Arterienklemmen	51
		ROSS Aortahaken	76
Q		RUMEL Arterienklemmen	56
QUERVAIN Elevatorien	93	RUMEL-BELMONT Tourniquets	177
		RUSKIN Hohlmeisselzangen	101
		RUSKIN-LISTON Knochensplitterzangen	104
R		RYDER Nadelhalter PROMEDUR	86
RAGNELL Präparierscheren PROMEDUR	21	RYDER-MINI Nadelhalter PROMEDUR	86
RAGNELL-DAVIS Wundhaken	65		
RANKIN-CRILE Arterienklemmen	49	S	
RANKIN-KELLY Arterienklemmen	48	SANTULLI atraumatische Bulldogklemmen	142
RASIERKLINGEN brechbar	7	SAROT Arterienklemmen	52
Raspatorien	94-98	SAROT Nadelhalter PROMEDUR	84
ALEXANDER	94	SATINSKY Gefäß-Scheren	13
CUSHING	97	SAUERBRUCH Hohlmeisselzangen	103
DAVIDSON-ALEXANDER	96	SAUERBRUCH Rippenscheren	107
DOYEN	96	SAUERBRUCH-FREY Rippenscheren	108
FARABEUF	94	Saugrohre	89, 90
FARABEUF-COLLIN	94	Scheren	824, 180-182
KEY	94	feine chirurgische	8,10,11,16,21
KIRMISSION	94	Gefäß	13,17,18-20,24
LAMBOTTE	95	Lungen	13,17
LANGENBECK	94,95	Mikro	180-182
MATSON	97	Präparier	9,10,12,16,20-23
MATSON-ALEXANDER	94	PROMEDUR	21-24
OVERHOLT	97	SUPERCUT	89, 11-16
SCHNEIDER	95	SCHMID Gefässspatel	175
SCHNEIDER-SAUERBRUCH	94	SCHMID Gefäß-Spülkanülen	173
SEDILLOT	96	SCHNEIDER Raspatorien	95
SEMB	97	SCHNEIDER-SAUERBRUCH Raspatorien	95
REVERDIN Organspateln	69	SCHUMACHER Sternumscheren	108
REYNOLDS Präparierscheren	16	SCHWARTZ Bulldogclips	46
REYNOLDS Präparierscheren SUPERCUT	16	SCHWARTZ Clip-Anlegezange	46
Ringstripper	176	SEDILLOT Raspatorien	96
CANNON	176	Sehnenscheren	9
WALTON	176	STEVENS	9
Rippenkontraktoren	120	SELLORS Rippenkontraktoren	120
Rippenscheren	105-108	SEMB Bronchusklemmen	123
BETHUNE	107	SEMB Knochehalte zangen mit Sperre	99
BRUNNER	108	SEMB Knochenhalte zangen	99
CORYLLOS-BETHUNE	107	SEMB Rippenraspatorien	97
GLUCK	106	SEMB Rippenscheren	107
LEBSCH	108	SIMS Präparierscheren PROMEDUR	22
SAUERBRUCH	107	Skalpellgriffe	3, 6
SAUERBRUCH-FREY	108	ANATOMIE	6
SCHUMACHER	108	BARRON	6
SEMB	107	COLLIN	4
STILLE	106	für Mikro-Skalpellklingen	6
STILLE-GIERTZ	107	Skalpellklingen	1,2,6
STILLE-HORSLEY	105,107	SMITH-PETERSEN Hohlmeisselzangen	102
Rippensperrer	111-119	Sterilisierbehälter für Tunnelierset	174
BURFORD	117	Sternummeißel	108
BURFORD-FINOCHIETTO	117	LEBSCH	108
CASTANEDA	115	Sternumschere	108
COOLEY	111	SCHUMACHER	108
COOLEY "XL"	111	STEVENS Sehnenscheren	9
DE BOER	118	STILLE Hohlmeisselzangen	102
DEBAKEY	109,110,118	STILLE Rippenscheren	106
FINOCHIETTO	112,116	STILLE-GIERTZ Rippenscheren	107
FINOCHIETTO-BABY-HAIGHT	112,113	STILLE-HORSLEY Knochensplitterzangen	105
FINOCHIETTO-MODIFIZIERT	113	STILLE-HORSLEY Rippenscheren	107
MERCEDES	119	STILLE-LISTON Knochensplitterzangen	104
MORSE-COOLEY	112	STILLE-LUER Hohlmeisselzangen	102
MORSE-FAVOLORO	114	STILLE-RUSKIN Hohlmeisselzangen	102
MORSE-STERNAL	114	STRABISMUS Scheren	9,21
TUFFIER	116	STRABISMUS Scheren PROMEDUR	21
BAILEY	120		
BAILEY-BABY	120		

	Seite		Seite
STRABISMUS Scheren SUPERCUT	9	WYLIE Aorta-Anastomosenklemmen	159
STRANDELL-STILLE Wundhaken	63	WYLIE Unterbauchklemmen	172
STRATTE Nadelhalter PROMEDUR	84		
SUPERCUT Scheren	8,9,11-16		
T			
THOMS-ALLIS Gewebefaßzangen	60		
THOREK (HALLE) Präparierscheren	13		
THOREK Lungenscheren	13		
TOENNIS Präparierscheren	15		
TOENNIS-ADSON Präparierscheren	15,22		
Tourniquets	177		
RUMEL-BELMONT	177		
TROUTMAN Klingenbrecher und -halter	7		
TUBBS Dilatator für Mitralstenose	178		
TUFFIER Organspateln	69		
TUFFIER Rippenspreizer	116		
TUNNELIER-Besteck	174		
U			
ULRICH Knochenhaltezangen	100		
UNIVERSAL Draht- und Ligaturscheren PROMEDUR	24		
V			
VANNAS-Mikro Scheren mit Profilgriff	181		
W			
WALKER Irisscheren	8		
WALTON Ringstripper	176		
WANGENSTEEN Nadelhalter PROMEDUR	83		
WANGENSTEEN Pinzetten PROMEDUR	36		
WASSMUND Wundhaken	66		
WAUGH anatomische Pinzetten	27		
WEBER Aortenklemmen	157		
WEITLANER Wundsperrer	79		
WEITLANER-BABY Wundsperrer	79		
WERTHEIM Scheren	12		
WERTHEIM-DEBAKEY Arterienklemmen	58		
WICKHAM Anlegezange	143		
WICKHAM Bulldogklemmen	143		
WIKSTROEM Arterienklemmen	57		
WILLIAMS Gewebefaßzangen	60		
Wundhaken	63-68		
BROM	63		
CUSHING	64		
GILLIES	63		
GIL-VERNET	65		
GOELET	65		
GREEN	68		
KIRKLIN	63		
KLAPP	64		
KOCHER	66		
KOCHER	67		
KÖNIG	64		
MIDDELDORPF	67,68		
MOBERG	63		
MORSE	66		
RAGNELL-DAVIS	65		
STRANDELL-STILLE	63		
WASSMUND	66		
ZENKER	68		
Wundsperrer	79-80,121		
ALLPORT	79		
ALM	79		
BECKMAN-WEITLANER	80		
FAVALORO	121		
FAVALORO-OCHSNER	121		
WEITLANER	79		
WEITLANER-BABY	79		

ALPHABETICAL INDEX**A**

ACLAND Modif. Approximators	185
ACLAND Modif. Approximators with frame	185
ACLAND Modif. Twin-Clamps	185
ACLAND Modif. Vessel Clamps	185
ADSON Dressing Forceps	25
ADSON Dressing Forceps TITAN	25
ADSON Dressing Forceps PROMEDUR	36
ADSON Hemostatic Forceps	49
ADSON Tissue Forceps	28,36
ADSON Tissue Forceps TITAN	28
ADSON-BABY Hemostatic Forceps	50
ADSON-BABY Self-Retaining Retractors	80
ADSON-BROWN Tissue Forceps PROMEDUR	37
ADSON-DEBAKEY Tissue Forceps	28
ADSON-GRAEFE Tissue Forceps	28
ADSON-MICRO Dressing Forceps	25
ADSON-MICRO Tissue Forceps	28
ALDERDYCE Elevator	93
ALEXANDER Raspatory	95
ALLIS Atraumatic Tissue Forceps	5
ALLIS Tissue Forceps	59
ALLIS-ADAIR Tissue Forceps	59
ALLIS-BABY Tissue Forceps	59
ALLISON Lung Spatulas	72
ALLPORT Self-Retaining Retractors	79
ALM Self-Retaining Retractors	79
ANATOMY Scissors	9
ANDREW-PYNCHON Suction Tube	89
Aorta Punches	177
Aortic Valve Rongeurs	177
Applying Forceps for ACLAND Clamps	185
Applying Forceps for Micro-Clips	45,185
Arteriotomy-Scissors	18
Atraumatic Dressing Forceps	25,34-35

B

BABCOCK Tissue Forceps	60
BABCOCK Tissue Forceps PROMEDUR	61
BABCOCK-DEBAKEY Tissue Forceps	61
BABY-CRILE-WOOD Needleholders	81
BAILEY Aortic Valve Rongeurs	177
BAILEY Rib Contractor	120
BAILEY-BABY Rib Contractor	120
BAILEY-GIBBON Rib Contractor	120
BARRAQUER Bladebreaker & -holder	7
BECKMAN-WEITLANER Self-Retaining Retractors	80
BENGOLEA Hemostatic Forceps	50
BERRY STERNAL Needleholders	82
BETHUNE Rib Shears	107
BEYER Bone Rongeur	101
BIPOLAR Coagulating Forceps	38-42
BIPOL-Cables for bipolar Coagulating Forceps	43
Blade Breakers and Holders	7
BARRAQUER	7
CASTROVIEJO	7
TROUTMAN	7
BLANK atraumatic Dressing Forceps	25
Bone Cutting Forceps	104-105
RUSKIN-LISTON	104
STILLE-HORSLEY	105
STILLE-LISTON	104
Bone Holding and Rib Forceps	99-100
FARABEUF	99
FARABEUF-LAMBOTTE	99
FERGUSON	99
LANGENBECK	99
SEMB	99
ULRICH	100
Bone Rongeurs	101-103

BEYER	101
MARQUARDT	101
MAYFIELD	101
RUSKIN	101
SAUERBRUCH	103
SMITH-PETERSEN	102
STILLE	102
STILLE-LUER	102
STILLE-RUSKIN	102
ZAUFAL-JANSEN	101
BONNEY Tissue Forceps PROMEDUR	37
BOWMAN Vascular Scissors	17
BOYS-ALLIS Tissue Forceps	60
BOZEMANN Needleholders	83
BRIDGE Hemostatic Forceps	50
BROM Vein Hooks	63
Bronchus Clamps	122, 123
BROPHY Dressing Forceps	25
BROPHY Tissue Forceps	29
BRUNNER Rib Shears	108
Bulldog Clamps	140-147
BURFORD Rib Spreaders	117
BURFORD-FINOCHIETTO Rib Spreaders	117

C

Cables for bipolar Coagulating Forceps	43
CANNON Endarterectomy Set	176
CASTANEDA Neonatal Clamps	137
CASTANEDA Rib Spreaders	115
CASTROVIEJO Bladebreaker	7
CASTROVIEJO Needleholders	87
CASTROVIEJO Needleholders PROMEDUR	87
Clips	45,185
ACLAND modif.	145
Bulldog	45,46,140-145,147
DIEFFENBACH	45
JOHNS-HOPKINS	45
Miniature	144
SCHWARTZ	46
TITAN	144
Coagulating Forceps, bipolar	38-42
COBB Elevators	93
COLLIN Tissue Forceps	62
COOLEY Atraumatic Tissue Forceps	35
COOLEY Atraumatic Tissue Forceps TITAN	35
COOLEY Auricle Retractors	77
COOLEY Rib Spreaders	111
COOLEY Suction Tubes	90
COOLEY Vascular Clamps	124-139
Anastomosis Clamps	124,126,128,135
Carotid Clamps	131
Coarctation Clamps	127
Clamps Iliac Clamps	133
Ligature Clamps	128
Multi-purpose Clamps	125,131,133-136,
Neonatal- and Pediatric Clamps	124,136,138-139
Patent-Ductus Clamps	127,130,
Renal Artery Clamps	128
Ring Handle Bulldog Clamps	129
Tangential Occlusion Clamps	132
Vena Cava Occlusion Clamps	132
COOLEY-BABY Vascular Clamps	138
COOLEY-BECK Anastomosis Clamps	128
COOLEY-DERRA Anastomosis Clamps	124
COOLEY-PARRY Anastomosis Clamp	135
COOLEY-SATINSKY Pediatric Clamp	124
CORYLLOS-BETHUNE Rib Shears	107
CRAFOORD Hemostatic Forceps	51
CRAFOORD Thoracic Scissors	17
CRAFOORD-SELLORS Hemostatic Forceps	52
CRAWFORD Aorta Hooks	77
CRILE Hemostatic Forceps	48
CRILE Hemostatic Forceps TITAN	48

	Page		Page
CRILE-BABY Hemostatic Forceps	48	DEMARTELL Vascular Scissors	20
CRILE-RANKIN Hemostatic Forceps	49	DICK Clamp-Forceps	58
CRILE-WOOD Needleholders	81	DIEFFENBACH Bulldog Clips	45
CRILE-WOOD-BABY Needleholders	81	DIETHRICH Aortic Clamps	158
CUSHING Dressing Forceps	26	DIETHRICH Intracardiac Needleholders	87
CUSHING Dressing Forceps PROMEDUR	36	DIETRICH Bulldog Clamps	142
CUSHING Nerve- and Vein Retractors	64	Dilators for mitral valve	178
CUSHING Raspatories	98	DOYEN Rib Raspatories	96
CUSHING Tissue Forceps	30	Dressing Forceps	25-27
D		ADSON	25
DANDY Hemostatic Forceps	48	ADSON-MICRO	25
DARDICK Multipurpose Clamps	134	BLANK	25
DAVIDSON Scapula Retractors	73	BROPHY	25
DAVIDSON-ALEXANDER Rib Raspatory	96	CUSHING	25,36
DE BOER Rib Spreader	118	DEBAKEY-GERALD	25
DEAVER fine Surgical Scissors	10	DUEHRSSSEN	25
DEAVER Lung Spatulas	70	FINO	25
DEBAKEY atraumatic Tissue Forceps	34,35	GERALD	25
DEBAKEY atraumatic Tissue Forceps TITAN	34,35	GRAEFE	25
DEBAKEY atraumatic Tissue Forceps PROMEDUR	37	McINDOE	25
DEBAKEY Bulldog Clamps	145-146	MICRO	28,179
DEBAKEY Dissecting Scissors	15	POTTS-SMITH	25
DEBAKEY Needleholders	82	WAUGH	26
DEBAKEY Rib Spreaders	109,110,118	DRESSING Forceps TITAN	25
DEBAKEY Suction Tube	89	Dressing Forceps atraumatic	25,34-35
DEBAKEY Tissue & Organ Grasping Forceps	58	DRESSING Forceps FINO	25
DEBAKEY Vascular Dilators	173	DRESSING Forceps PROMEDUR	36
DEBAKEY Vascular Forceps	148-172	DUEHRSSSEN Dressing Forceps	26
Abdominal Clamps	172	DUEHRSSSEN Tissue Forceps	30
Anastomosis Clamps	166,170,171	DUVAL Tissue Forceps	62
Aortic Aneurysm Clamps	154-155	DUVAL Tissue Forceps PROMEDUR	62
Aortic Anostomosis Clamps	160,166,170,171	E	
Aortic Clamps	152,156-160,165,171	Elevators	93,94,97
Bronchus Clamps	168	ALDERDYCE	93
Coarctation Clamps	149,165,167	COBB	93
Hypogastric Clamps	172	KEY	94
Ligature Clamps	156,169	LANGENBECK	93
Multi-Purpose Clamps	151,161,169,	Periosteal-	97
Patent Ductus Clamps	149,165,170	QUERVAIN	93
Peripheral Vascular Clamps	150,152,153	Enderterectomy Set	176
Profunda Clamps	153	F	
Renal Artery Clamps	151	FARABEUF Bone Holding Forceps	99
Tangential Occluding Clamps	160	FARABEUF Raspatories	94
Thoracic Dissecting Clamps	168	FARABEUF-COLLIN Raspatories	94
Thorax- and Auricle Clamps	164	FARABEUF-LAMBOTTE Boneholding Forceps	99
Vena-Cava Clamps	163	FAVALORO IMA Retractor	121
DEBAKEY Vascular Scissors PROMEDUR	24	FAVALORO Vascular Scissors	19
DEBAKEY-BAHNSON Aortic Clamps	156	FAVALORO-OCHSNER IMA Retractor	121
DEBAKEY-BAINBRIDGE Vascular Clamps	151	FEATHERLIGHT Bulldog Clamps	143
DEBAKEY-BECK Anastomosis Clamps	170,171	FERGUSSON Boneholding Forceps	99
DEBAKEY-BECK Aortic Clamps	165	FERRIS-SMITH Tissue Forceps	29
DEBAKEY-CAROTID Bulldog Clamps	147	Fine Retractors	63-65
DEBAKEY-DALE Peripheral Vascular Clamps	153	FINOCCHIETTO Bronchus Forceps	122
DEBAKEY-DERRA Anastomosis Clamps	170	FINOCHIETTO Needleholders	82
DEBAKEY-DIETRICH Aortic Clamps	152	FINOCHIETTO Rib Spreaders	112,116
DEBAKEY-GERALD atraumatic Dressing Forceps	26	FINOCHIETTO-BABY-HAIGHT Rib Spreaders	112,113
DEBAKEY-GLOVER Coarctation Clamps	170	FINOCHIETTO-Modif. Rib Spreader	113
DEBAKEY-GLOVER Ductus Clamps	169	Forceps, bipolar coagulating	38-42
DEBAKEY-GREGORY Profunda Clamps	153	G	
DEBAKEY-HARKEN Thorax- and Auricle Clamps	164	GARRETT Vascular Dilators	173
DEBAKEY-LAMBERT Aortic Anastomosis Clamps	160	GEMINI Hemostatic Forceps	56
DEBAKEY-MICRO Bulldog Clamps	145	GEMINI-MINI Hemostatic Forceps	56
DEBAKEY-MICRO non-traumatic Dressing Forceps	35	GERALD atraumatic Forceps PROMEDUR	37
DEBAKEY-MICRO non-traumatic Dressing Forceps TITAN	35	GERALD Dressing Forceps	26
DEBAKEY-MORRIS Aorta Clamps	162	GERALD Tissue Forceps	30
DEBAKEY-MOSQUITO Hemostatic Forceps	148	GERALD Tissue Forceps PROMEDUR	37
DEBAKEY-OCHSNER Aortic Clamps	152	GERALD-DEBAKEY atraumatic Dressing Forceps	26
DEBAKEY-PEAN Hemostatic Forceps	148		
DEBAKEY-REYNOLDS Anastomosis Clamps	171		
DEBAKEY-SATINSKY Bulldog Clamps	147		
DEBAKEY-SATINSKY Vena Cava Clamps	163		
DEBAKEY-WYLIE Vascular Clamps	159		

	Page		Page
GILLIES Fine Hooklet	63	ROCHESTER-PEAN	51
GILLIES Needleholders	86	RUMEL	56
GILLIES Tissue Forceps TITAN	28	SAROT	52
GIL-VERNET Vein- and Hillar Retractors	65	WERTHEIM-DEBAKEY	58
GLOVER Anastomosis Clamps	166	WIKSTROEM	57
GLOVER Bulldog Clamps	140	ZENKER	52
GLOVER Patent Ductus Clamps	165	HENLY Anastomosis Clamp	170
GLUCK Rib Shears	106		
GOELET Retractor	65	I	
GOLDMAN-FOX fine Surgical Scissors PROMEDUR	21	Intima Dissectors	175
GORNEY Dissecting Scissors	20	Intima Spatulas	175
GRAEFE fine Dressing Forceps	25	INTRACARDIAC Needleholders	87
GRAEFE Fine Tissue Forceps	28	IRIS Scissors	8,21
GREEN Retractor	68	FOR LEFT HAND	8
GREGORY Bulldog Clamps	141	WALKER	8
Guide Needles	91	with large rings	8
		PROMEDUR	21
		SUPERCUT	8
		Irrigating Cannulas	173
H		J	
HABERER Intestinal Spatulas	69	JAMESON delicate Dissecting Scissors	16
HALSTED Hemostatic Forceps	49	JAMESON delicate Dissecting Scissors SUPERCUT	16
HALSTED-MOSQUITO Hemostatic Forceps	47	JAVID Carotid Clamps	131
HALSTED-MOSQUITO Hemostatic Forceps LEFT HAND	46	JOHN-HOPKINS Applying Forceps	45
HARRINGTON Bronchus Forceps	122	JOHNS-HOPKINS Bulldog Clips	45
HARRINGTON Lung Spatulas	71	JUDD-ALLIS Tissue Forceps	60
HARTMANN Hemostatic Forceps	46	JULIAN Needleholders	82
HARTMANN-MICRO Hemostatic Forceps	46		
HEANEY Needleholders	84	K	
HEGEMANN Vascular Scissors	18	KADER Intestinal Spatulas	69
HEISS Hemostatic Forceps	50	KANTROWITZ Hemostatic Forceps	56
Hemostatic Forceps	46-58	KELLY Fistula Scissors	11
ADSON	49,50	KELLY Hemostatic Forceps	47,55
ADSON-BABY	50	KELLY Hemostatic Forceps TITAN	47
BABY-CRILE	48	KELLY Surgical Scissors serrated	11
BABY-MIXTER	57	KELLY-RANKIN Hemostatic Forceps	48
BENGOLEA	50	KEY Elevators	94
BRIDGE	50	KILNER Needleholders	81
CRAFOORD	51	KIRKLIN Vein Hooks malleable	63
CRAFOORD-SELLORS	52	KIRMISSION Raspatory	94
CRILE	48	KLAPP Tendon Hooks	64
CRILE-RANKIN	49	KLINGENBERG-LOTH Thoracic Scissors	13
DANDY	48	KOCHER Hemostatic Forceps	52
DEBAKEY	58	KOCHER Retractors	66,67
DICK	58	KÖNIG Retractors	64
GEMINI	56		
GEMINI-MINI	56	L	
HALSTED	49	LAHEY-METZENBAUM Dissecting Scissors	15
HALSTED-MICRO	47	LAMBERT-KAY Aortic Anastis Clamps	160
HALSTED-MOSQUITO	46,47	LAMBOTTE Raspatories	95
HARTMANN	46	LANGENBECK Bone Holding Forceps	99
HARTMANN-MICRO	46	LANGENBECK ElevatorS	93
HEISS	50	LANGENBECK Needleholders	84
KANTROWITZ	56	LANGENBECK Raspatories	94,95
KELLY	47,55	LEBSCHE Sternum Chisel	108
KELLY-RANKIN	48	LEBSCHE Sternum Shears	108
KOCHER	52	LEES Bronchus Clamps	168
KOCHER-FINO	52	LELAND-JONES Peripheral Vascular Clamps	152
LERICHE	48	LEMMON Intima Dissectors	175
LOVELACE	48	LEMMON Rib Contractor	120
MEEKER	57	LERICHE Hemostatic Forceps	48
MICRO-HALSTED	47	LEXER-BABY Dissecting Scissors	15
MIXTER	57	LEXER-BABY Dissecting Scissors PROMEDUR	21
MIXTER-BABY	57	LICHTENBERG Needleholders	85
MIXTER-O'SHAUGHNESSY	54	Ligature Clamps	123,128,156
OVERHOLT-BABY	54	LOCKWOOD Tissue Forceps	60
OVERHOLT-GEISSENDOERFER	54	LOVELACE Hemostatic Forceps	48
OVERHOLT-MIXTER	54	LOVELACE Lunggrasping Forceps	123
PEAN-FINO	51		
PROVIDENCE-HOSPITAL	47		
RANKIN-CRILE	49		
RANKIN-KELLY	48		
ROBERTS	51		
ROCHESTER-CARMALT	51		
ROCHESTER-OCHSNER	53		

	Page		Page
M			
MARQUARDT Bone Rongeur	101	JULIAN	82
MASSON Needleholders	83	KILNER	81
MATHIEU Needleholders	85	LANGENBECK	84
MATHIEU-KOCHER Needleholders	85	LICHTENBERG	85
MATSON Raspatory-Elevator	97	MASSON	83
MATSON-ALEXANDER Rib Raspatory-Elevator	95	MATHIEU	85
MAYFIELD Bone Rongeur	101	MATHIEU-KOCHER	85
MAYO Dissecting Scissors	12	MAYO-HEGAR	81
MAYO Dissecting Scissors PROMEDUR	22	Micro-	182-183
MAYO Dissecting Scissors SUPERCUT	12	MICRO-VASCULAR	82
MAYO-HARRINGTON Scissors PROMEDUR	22	MINI-RYDER	86
MAYO-HEGAR Needleholders	81	NEIVERT	81
MAYO-STILLE Scissors	12	OLSENHEGAR	86
MAYO-STILLE Scissors PROMEDUR	22	RYDER	86
MAYO-STILLE Scissors SUPERCUT	12	RYDER-MINI	86
McINDOE Dressing Forceps	25	SAROT	84
McINDOE Dressing Forceps TITAN	25	Sternal	82
MEEKER Hemostatic Forceps	57	STRATTE	84
MERCEDES Rib Spreader	119	WANGENSTEEN	83
METZENBAUM Dissecting Scissors	14	NEIVERT Needleholders	81
METZENBAUM Dissecting Scissors PROMEDUR	23	NEONATAL Pediatric Clamps	136,139
METZENBAUM-BABY Dissecting Scissors	13	O	
METZENBAUM-BABY Dissecting Scissors SUPERCUT	13	OCHSNER-KOCHER Hemostatic Forceps	53
METZENBAUM-FINO Dissecting Scissors	14	OEHLER Tissue Forceps PROMEDUR	37
METZENBAUM-FINO Dissecting Scissors PROMEDUR	23	OLSEN-HEGAR Needleholders	86
METZENBAUM-FINO Dissecting Scissors SUPERCUT	14	Organ Holding Forceps	58-62
METZENBAUM-X-FINO Dissecting Scissors PROMEDUR	23	OVERHOLT Periosteal Elevators	97
MICRO Dressing Forceps	27	OVERHOLT-BABY Hemostatic Forceps	54
MICRO-Clip Applying Forceps	45,185	OVERHOLT-GEISSENDOERFER Hemostatic Forceps	54
ACLAND modif.	185	OVERHOLT-MIXTER Hemostatic Forceps	54
MICRO-Clips	45,185	P	
ACLAND modif.	185	PEAN-FINO Hemostatic Forceps	51
MICRO-DEBAKEY non-traumatic Dressing Forceps	35	POLLOSON Retractors	74-75
MICRO-DEBAKEY non-traumatic Dressing Forceps TITAN	35	POOLE Suction Tubes	89
Micro-Dissecting-Scissors with profile handle	180	POTTS Dissecting Scissors	10
Micro-Forceps with profile handle	179	POTTS Patent Ductus Clamps	165
MICRO-MOSQUITO Hemostatic Forceps	47	POTTS-DE-MARTEL Vascular Scissors	7
Micro-Needleholders with profile handle	183-184	POTTS-SMITH Dressing Forceps	26
Micro-Scissors with profile handle	180-182	POTTS-SMITH Dressing Forceps PROMEDUR	36
MICRO-VASCULAR Needleholders	82	POTTS-SMITH Dressing Forceps TITAN	26
MICRO-Vascular Scissors	180-182	POTTS-SMITH Tissue Forceps	30
MIDDELORPF Retractors	67,68	POTTS-SMITH Vascular Scissors	18,19
MINI-RYDER Needleholders	86	POTTS-SMITH Vascular Scissors SUPERCUT	18
MIXTER Hemostatic Forceps	57	POTTS-SMITH Vascular Scissors PROMEDUR	24
MIXTER Surgical Scissors	11	PRICE-THOMAS Bronchus Forceps	122
MIXTER-BABY Hemostatic Forceps	57	PROVIDENDE-HOSPITAL Hemostatic Forceps	47
MIXTER-O'SHAUGHNESSY Hemostatic Forceps	54	Q	
MOBERG Retractors	63	QUERVAIN Elevator	93
MORRIS Vascular Retractor	178	R	
MORSE Retractors	66	RAGNELL delicate Retractor	65
MORSE-COOLEY Rib Spreaders	112	RAGNELL Scissors PROMEDUR	21
MORSE-FAVALORO Rib Spreader	114	RANKIN-CRILE Hemostatic Forceps	49
MORSE-STERNAL Spreaders	114	RANKIN-KELLY Hemostatic Forceps	48
MOSQUITO Hemostatic Forceps	47	Raspatories	94-98
MOSQUITO Hemostatic Forceps TITAN	47	ALEXANDER	95
N			
NABATOFF Varicose Stripper Set	92	CUSHING	98
NAGEL Micro-Scissors with profile handle	182	DAVIDSON-ALEXANDER	96
Needleholders	81-87,182-183	DOYEN	96
BABY-CRILE-WOOD	81	FARABEUF	94
BERRY Sternal	82	FARABEUF-COLLIN	94
BOZEMANN	83	KIRMISSION	94
CASTROVIEJO	87	LAMBOTTE	95
CRILE-WOOD	81	LANGENBECK	94,95
CRILE-WOOD-BABY	81	MATSON	97
DEBAKEY	82	MATSON-ALEXANDER	95
DIETRICH	87		
FINOCHIETTO	82		
GILLIES	86		
HEANEY	84		
INTRACARDIAC	87		

	Page		Page
OVERHOLT	97	Ring Strippers	176
Rib-	95-97	ROBB Intima Spatulas	175
Razor-Blades breakable	7	ROBERTS Hemostatic Forceps	51
REDON Guide Needles	91	ROCHESTER-CARMALT Hemostatic Forceps	51
Retractors ALLISON	72	ROCHESTER-OCHSNER Hemostatic Forceps	53
Aorta	76	ROCHESTER-PEAN Hemostatic Forceps	51
Auricle-	77	ROSS Aorta Retractors	76
BROM	63	RUMEL Dissecting Forceps	56
CRAWFORD Aorta-	77	RUMEL-BELMONT Tourniquets	177
CUSHING	64	RUSKIN Bone Rongeurs	101
DAVIDSON	73	RUSKIN-LISTON Bone Cutting Forceps	104
DEAVER	70	RYDER Needleholders	86
fine	63-65	RYDER-MINI Needleholders	86
GILLIES	63		
GIL-VERNET	65	S	
GOELET	65	SANTULLI Bulldog Clamps	142
GREEN	68	SAROT Hemostatic Forceps	52
HABERER	69	SAROT Needleholders	84
HARRINGTON	71	SATINSKY Tangential Occluding Clamps	160
KADER	69	SATINSKY Vascular Sissors	13
KIRKLIN	63	SAUERBRUCH Bone Rongeurs square	103
KLAPP	64	SAUERBRUCH Rib Shears	107
KOCHER	66,67	SAUERBRUCH-FREY Rib Shears	108
KOENIG	64	Scalpel Blades	1-2,6
MIDDELDORPF	67,68	Micro Blades	6
MOBERG	63	POST-MORTEM Blades	2
MORSE	66	Scalpel Handles	3-7
POLLOSON	74-75	ANATOMY	6
RAGNELL-DAVIS	65	BARRON	6
REVERDIN	69	calibrated	3
ROSS Aorta-	76	COLLIN	4
STRANDELL-STILLE	63	Micro-Blade Handles	6
TUFFIER	69	SCHMID Irrigating Cannulas	173
Vein-	63,64-66	SCHNEIDER Raspatory	95
WASSMUND	66	SCHNEIDER-SAUERBRUCH Rib Raspatory	95
ZENKER	68	SCHUMACHER Sternum Shears	108
Retractors Self-Retaining	79-80,121	SCHWARTZ Applying Forceps	46
Vascular-	178	SCHWARTZ Bulldog Clips	46
REVERDIN Intestinal Spatulas	69	Scissors	8-24,180-182
REYNOLDS delicate Dissecting Scissors	16	ARTERIOTOMY	18
REYNOLDS delicate Dissecting Scissors SUPERCUT	16	BOWMAN	17
Rib Contractors	120	CRAFOORD	17
Rib Shears	104-108	DEAVER	10
BETHUNE	107	DEBAKEY	15,19,24
BRUNNER	108	Dissecting	12,14,15,20,22,23
CORYLLOS-BETHUNE	107	FAVOLORO	19
GLUCK	106	fine Dissecting	9,10,13,15,16,21,23,24
LEBSCHKE	108	Fine Surcical SUPERUT	8,10,11,16,21
SAUERBRUCH	107	Fine Surgical	9,10
SAUERBRUCH-FREY	108	Fine Surgical PROMEDUR	21
SCHUMACHER	108	GOLDMAN-FOX	21
SEMB	107	GORNEY	20
STILLE	106	HEGEMANN	18
STILLE-GIERTZ	107	HEGEMANN_DIETHRICH	18
STILLE-HORLEY	107	Iris	8,22
STILLE-LISTON	105	JAMESON	16
Rib Spreaders	109-119	KELLY	11
BURFORD	117	KLINGENBERG-LOTH	13
BURFORD-FINOCHIETTO	117	LAHEY-METZENBAUM	15
CASTANEDA	115	LEXER-BABY	15,22
COOLEY	111	Lung	17
DE BOER	118	MAYO	12,22
DEBAKEY	109-110,118	MAYO-HARRINGTON	22
FINOCHIETTO	112,116,	MAYO-LEXER	22
FINOCHIETTO Modified	113	MAYO-STILLE	12,22
FINOCHIETTO-BABY-HAIGHT	112,113	METZENBAUM	14,23
MERCEDES	119	METZENBAUM-BABY	13
MORSE-COOLEY	112	METZENBAUM-FINO	14,23
MORSE-FAVOLORO	114	METZENBAUM-X-FINO	23
MORSTE-STERNAL	114	Micro	180-182
TUFFIER	116	MIXTER	11
Rib-Raspatories SCHNEIDER	95	POTS-DE MARTEL	20
SCHNEIDER-SAUERBRUCH	95	POTTS	10
SEDILLOT	96		
SEMB	97		

	Page		Page
POTTS-SMITH	18,19,24	JUDD-ALLIS	60
RAGNELL	21	LOCKWOOD	60
REYNOLDS	16	SINGLEY (Tuttle)	32
SATINSKY	13	THOMS-ALLIS	60
SIMS	22	WANGENSTEEN	32,36
Strabismus	9,21	WILLIAMS	60
Tenotomy	9	Tissue Forceps	28-33
THOREK	13	ADSON-BROWN	31,37
TOENNIS	15	ADSON-DEBAKEY	29
TOENNIS-ADSON	15,22	ADSON-GRAEFE	29
Universal Ligature	24	ADSON-MICRO	29
UNIVERSAL Ligature	23	ALDERKREUZ	31
Vascular	17-20,24	BONNEY	31,37
VASCULAR	17	BROPHY	29
Vena Cava	13	BROWN	31
WERTHEIM	12	CUSHING	30
SEDILLOT Raspatories	96	DUEHRSSSEN	30
SELLORS Rib Contractor	120	DURANTE	33
SEMB Bone Holding Forceps	99	FERRIS-SMITH	29
SEMB Bronchus Clamp	123	FINO	29
SEMB Ligature Clamp	123	GERALD	30,37
SEMB Rib Raspatories	97	GILLIES	29
SEMB Rib Shears	107	GRAEFE	29
SIMS Dissecting Scissors PROMEDUR	22	LANE	32
SMITH-PETERSON Bone Rongeurs	102	LERCHE	31
Spatulas, lung and aorta	70-72,74-75	MAYO-RUSSIAN	32
Spatulas, scapula	73	NELSON	31
Spatulas, vascular	175	OEHLER	37
Sterilizing Case for Tunneling Set	174	POTTS-SMITH	30
Sternum Chisel	108	RUSSIAN	32
Sternum Shears	108	STILLE-BARRAYA	32
STEVENS Tenotomy Scissors	9	STONE	31
STEVENS Tenotomy Scissors SUPERCUT	9	TITAN	25,26,27
STILLE Bone Rongeur	102	WAUGH	33
STILLE Rib Shears	106	TISSUE Forceps FINO	29
STILLE-GIERTZ Rib Shears	107	TOENNIS Dissecting Scissors	15
STILLE-HORSLEY Rib Shears	105,107	TOENNIS-ADSON Dissecting Scissors PROMEDUR	22
STILLE-LISTON Bone Cutting Forceps	104	TOENNIS-ADSON Dissecting Scissors SUPERCUT	15
STILLE-LUER Rongeurs	102	Tourniquets	177
STILLE-RUSKIN Bone Rongeurs	102	TROUTMAN Blade Breaker	7
STRABISMUS Scissors	9,21	TUBBS Dilator for mitral valve	178
STRABISMUS Scissors PROMEDUR	21	TUFFIER Intestinal Spatulas	69
STRABISMUS Scissors SUPERCUT	9	TUFFIER Rib Spreader	116
STRANDELL-STILLE Tendon Sheath Retractors	63	Tunneling Set	174
STRATTE Needleholders	84		
Suction Tubes	89-90	U	
ANDREW-PYNCHON	89	ULRICH Bone Holding Forceps	100
COOLEY	90	UNIVERSAL Wire & Ligature Cutting Scissors PROMEDUR	24
DEBAKEY	89		
POOLE	89	V	
YANKAUER	89	VANNAS-Micro Scissors with profile handle	181
Surgical Scissors FINE	8-11,13,21	Vascular Dilators	173
Surgical Scissors FINE PROMEDUR	21,22,23	Vascular Scissors	17-20,24
Surgical Scissors FINE SUPERCUT	8,10,11,16,21	Vascular Spatulas	175
		Vricose Stripper Set NABATOFF	92
T			
THOMS-ALLIS Tissue- and Organholding Forceps	60	W	
THOREK (HALLE) Dissecting Scissors	13	WALTON Ring Strippers	176
THOREK Thoracic Scissors	13	WANGENSTEEN Dressing Forceps PROMEDUR	36
Tissue- and Organholding Forceps	32-33,58-62	WANGENSTEEN Needleholders	83
ALLIS	59	WASSMUND Retractor	66
ALLIS-ADAIR	59	WAUGH Dressing Forceps	27
ALLIS-BABY	59	WEBER Aortic Clamps	157
BABCOCK	60-61	WEITLANER Self-Retaining Retractors	79
BABCOCK PROMEDUR	61	WEITLANER-BABY Self-Retaining Retractors	79
BABCOCK-DEBAKEY	61	WERTHEIM Dissecting Scissors	12
BOYS-ALLIS	60	WERTHEIM-DEBAKEY Atraumatic Forceps	58
COLLIN	61	WICKHAM Applying Forceps	143
COLLIN-DUVAL	33	WICKHAM Bulldog Clamps	143
DEBAKEY	58	WIKSTROEM Hemostatic Forceps	57
DUVAL	33,61		
DUVAL PROMEDUR	61		
DUVAL-DEBAKEY	61		

Page

WILLIAMS Tissue Forceps	60
WYLIE Hypogastric Clamps	172
WYLIE Vascular Clamps	159

Y

YANKAUER Suction Tube	89
-----------------------	----

Z

ZAUFAL-JANSEN Bone Rongeur	101
ZENKER Hemostatic Forceps	52
ZENKER Retractors	68

INDEX ALPHABÉTIQUE

Page

Page

A

ACLAND-modif. Approximateurs	185
ACLAND-modif. Clamps double	185
ACLAND-modif. Micro-Clamps vasculaires	185
ADSON Pincés à disséquer PROMEDUR	36
ADSON Pincés à disséquer	25,28,36
ADSON Pincés à disséquer TITAN	25
ADSON Pincés hémostatiques	49
ADSON-BABY Pincés hémostatiques	50
ADSON-BROWN Pincés à disséquer	31
ADSON-BROWN Pincés non-traumatisants PROMEDUR	37
ADSON-DEBAKEY Pincés à disséquer non-traumatisants	28
ADSON-GRAEFE Pincés à disséquer	28
ADSON-MICRO Pincés à disséquer	25,28
Aiguilles Guides	91
ALDERDYCE Elevateurs	93
ALDERKREUZ Pincés à disséquer	31
ALEXANDER Rugine	95
ALLIS Pincés à préhension	59
ALLIS-ADAIR Pincés à préhension	59
ALLIS-BABY Pincés à préhension	59
ALLISON Ecarteurs pulmonaires	72
ALLPORT Ecarteurs	79
ALM Ecarteurs	79
ANATOMIE Ciseaux	9
ANDREW-PYNCHON Canules à aspiration	89
ARTERIOTOMIE-Ciseaux	18
Aspirateurs	89

B

BABCOCK Pincés à préhension	60,61
BABCOCK-DEBAKEY Pincés à préhension	61
BABY-ADSON Pincés hémostatiques	50
BABY-CRILE Pincés hémostatiques	48
BABY-CRILE-WOOD Portes-aiguilles	81
BABY-MIXTER Pincés hémostatiques	57
BABY-OVERHOLT Pincés hémostatiques	54
BABY-WEITLANER Ecarteurs	79
BAILEY Pincés-perforatrice pour valve	177
BAILEY Rapprocheurs des côtes	120
BAILEY-BABY Rapprocheurs des côtes	120
BAILEY-GIBBON Rapprocheurs des côtes	120
BARRAQUER Portes-lames	7
BARRON Manches pour lames de bistouri	6
BECKMANN-WEITLANER Ecarteurs	80
BENGOLEA Pincés hémostatiques	50
BERRY STERNAL Portes-aiguilles	82
BETHUNE Costotome	107
BEYER Pince gouge	101
BLANK Pince à disséquer non-traumatisants	25
BONNEY Pincés à disséquer	31
BONNEY Pincés non-traumatisants PROMEDUR	37
BOWMAN Ciseaux vasculaire	17
BOYS-ALLIS Pincés à préhension	60
BOZEMANN Portes-aiguilles	83
BRIDGE Pincés hémostatiques	50
BROM Crochets pour veines	63
BROPHY Pincés à disséquer	25,29
BROWN Pincés à disséquer	31
BRUNNER Costotomes	108

C

CANNON Jeu pour endarterectomie	176
Canules à aspiration	89
ANDREW-PYNCHON	89
COOLEY	90
DEBAKEY	89

POOLE	89
YANKAUER	89
CASTANEDA Clamps pour nouveaux-nés et enfants	137
CASTROVIEJO Portes-aiguilles	87
CASTROVIEJO Portes-lames	7
Cisailles à sternum	108
LEBSCHKE	108
SCHUMACHER	108
Ciseaux coupe-fils et ligatures	24
Ciseaux à dissection	9-17,22,23
CRAFOORD	17
GORNEY	20
KLINGENBERG-LOTH	13
LAHEY-METZENBAUM	15
MAYO	12,22
MAYO-STILLE	12,22
METZENBAUM	14,23
THOREK	13
TOENNIS	15
TOENNIS-ADSON	15
WERTHEIM	12
Ciseaux fins à dissection	8,9-11,13-16,21
ANATOMIE	9
DEAVER	10
GOLDMAN-FOX	21
IRIS	8
JAMESON	16
KELLY	11
LEXER-BABY	15,21
METZENBAUM-BABY	13,23
METZENBAUM-FINO	14,23
MIXTER	11
POTTS	10
REYNOLDS	16
STEVENS	9
STRABISME	9
WALKER	8
PROMEDUR	21,23
SUPERCUT	8,9,11,13
Ciseaux pour Chirurgie Microvasculaire	18,180-182
Ciseaux pour la veine cave	13
SATINSKY	13
CISEAUX vasculaire boutonée	17
Ciseaux vasculaires	17-20,24
ARTERIOTOMY	18
BOWMAN	17
DEBAKEY	19,24
FAVOLORO	19
HEGEMANN	18
HEGEMANN-DIETRICH	18
POTTS-DE-MARTEL	20
POTTS-SMITH	18,24
VASCULAR	17
Clamps "Bulldog"	45,140-147
Clamps à compression	58
Clamps bronchique	52,122-123
Clamps-Bulldog non-traumatisants	140-147
DEBAKEY	145,146
DEBAKEY-CAROTID	147
DEBAKEY-MICRO	145
DEBAKEY-SATINSKY	147
DIETRICH	142
GLOVER	140
GREGORY	141
POIDS PLUME	143
SANTULLI	142
TITANIUM	144
WICKHAM	143
COAGULATION Pincés bipolaires	38
COBB Elevateurs	93
COLLIN Manches pour lames de bistouri	4
COLLIN Pincés à préhension	62
COLLIN-DUVAL Pincés à disséquer	33
COOLEY Canules à aspiration	90
COOLEY Clamps	124-136,138-140

	Page		Page
à ligatures	128	pour aneurisme de l'aorte	154,155,160,
pour anastomoses	124,126,128,135	pour application universelle	151,161,169
pour anastomoses	126,128,135	pour chirurgie abdominale	172
pour application universelle	125,131,133,134,135	pour chirurgie thoracique	168
pour artère iliaque	133	pour coarctation	165,167
pour artère rénale	128	pour coarctation et canal artériel	149,167
pour canal artériel et à coarctation	127	pour fémorale	153
pour la carotide	131	pour l'aorte	152,156-159,162
pour nouveaux-nés et enfants	124,136,138-139	pour ligatures	156
pour occlusion de la veine cava	132	pour occlusion tangentielle	160,
pour occlusion tangentielle	132	pour patent-ductus	165
pour patent-ductus	130	pour thorax et à oreillette	164
COOLEY Dilatateur aortique	178	pour vaisseaux périphériques	150,152,153
COOLEY Ecarteurs pour l'oreillette	7	pour veine cave	163
COOLEY Pincés à disséquer non-traumatisants	35	DEBAKEY Clamps-Bulldog	145
COOLEY Pincés à disséquer non-traumatisants TITAN	35	DEBAKEY Dilatateurs vasculaires	173
COOLEY-BABY Clamps pour nouveaux-nés et enfants	138	DEBAKEY Pince ovale	58
COOLEY-BECK Clamps à anastomose	128	DEBAKEY Pincés à disséquer non-traumatisants	34-35
COOLEY-DERRA Clamps à anastomose	124	DEBAKEY Pincés à disséquer non-traumatisants PROMEDUR	37
COOLEY-PARRY Clamps à anastomose	135	DEBAKEY Pincés à disséquer non-traumatisants TITAN	34-35
COOLEY-SATINSKY Clamps non-traumatisants	124	DEBAKEY Pincés non-traumatisants PROMEDUR	37
CORDONS pour pincés à coagulation bipolaire	43	DEBAKEY Pincés-Bulldog	146
CORYLLOS-BETHUNE Costotomes	107	DEBAKEY Portes-aiguilles	82
Costotomes	105-108	DEBAKEY-BAHNSON Clamps pour anévrisme de l'aorte	156
BETHUNE	107	DEBAKEY-BAINBRIDGE Clamps vasculaires	151
BRUNNER	108	DEBAKEY-BECK Clamps pour aorte	165,171
CORYLLOS-BETHUNE	107	DEBAKEY-CAROTID Clamps-Bulldog	147
GLUCK	106	DEBAKEY-DALE Clamps pour vaisseaux périphériques	153
SAUERBRUCH	107	DEBAKEY-DERRA Clamps à anastomose	170
SAUERBRUCH-FREY	108	DEBAKEY-DIETRICH Clamps pour l'aorte	152
SEMB	107	DEBAKEY-GERALD Pincés à disséquer non-traumatisants	26
STILLE	106	DEBAKEY-GLOVER Clamps à anastomose	169,170
STILLE-GIERTZ	107	DEBAKEY-HARKEN Clamps à disséquer et à ligatures	164
STILLE-HORSELEY	107	DEBAKEY-MICRO Clamps-Bulldog	145
STILLE-HORSLEY	105	DEBAKEY-MICRO-Pincettes	35
CRAFOORD Ciseaux pour le poumon	17	DEBAKEY-MORRIS Clamps para aorte	162
CRAFOORD Clamps bronchiques	51	DEBAKEY-MOSQUITO Pincés non-traumatisants	148
CRAFOORD-SELLORS Clamps bronchiques	52	DEBAKEY-OCHSNER Clamps para aorte	152
CRAWFORD Ecarteurs	77	DEBAKEY-PEAN Pincés non-traumatisants	148
CRILE Pincés hémostatiques	48	DEBAKEY-REYNOLDS Clamps pour anastomose	171
CRILE Pincés hémostatiques TITAN	48	DEBAKEY-SATINSKY Clamps non-traumatisants	160,163
CRILE-BABY Pincés hémostatiques	48	DEBAKEY-SATINSKY Clamps-Bulldog	147
CRILE-RANKIN Pincés hémostatiques	49	DEMARTELL Ciseaux vasculaires	20
CRILE-WOOD-BABY Portes-aiguilles	81	DICK Clamps à compression	58
Crochets pour veine	63-65	DIEFFENBACH Clamps "Bulldog"	45
CUSHING Ecarteurs	64	DIETHRICH Ciseaux vasculaires	18
CUSHING Pincés à disséquer	26,30,36	DIETHRICH Clamps non-traumatisants	158
CUSHING Pincés à disséquer PROMEDUR	36	DIETHRICH Portes-aiguilles	87
CUSHING Raspatoires	98	DIETRICH Clamps-Bulldog	142
		Dilatateurs vasculaires	173,178
		DOYEN Raspatoires	96
		DUEHRSEN Pincés à disséquer	26,30
		DURANTE Pincés à disséquer	33
		DUVAL Pincés à disséquer	33
		DUVAL Pincés à préhension	62
D		E	
DANDY Pincés hémostatiques	48	Ecarteurs	63-68
DARDICK Clamps pour application universelle	134	CUSHING	64
DAVIDSON Ecarteurs à scapula	73	GIL-VERNET	65
DAVIDSON-ALEXANDER Rugines	96	GOELET	65
Daviers	99-100	GREEN	68
FARABEUF	99	KIRKLIN	63
FARABEUF-LAMBOTTE	99	KLAPP	64
FERGUSON	99	KOCHER	66,67
LANGENBECK	99	KOENIG	64
SEMB	99	MIDDELDORPF	67,68
ULRICH	100	MOBERG	63
DEAVER Ciseaux opératoires délicats	10	MORSE	66
DEAVER Ecarteurs pulmonaires	70	POLLOSON	75-75
DEBAKEY Canules à aspiration	89	RAGNELL-DAVIS	65
DEBAKEY Ciseaux fins à dissection	15	STRANDELL-STILLE	63
DEBAKEY Ciseaux vasculaires	19,24	WASSMUND	66
DEBAKEY Ciseaux vasculaires PROMEDUR	24		
DEBAKEY Clamps	149		
à préhension	58		
bronchiques	168		
pour anastomoses	166,170,171		
pour anastomoses à l'aorte	160,		

	Page		Page
ZENKER	68	GREGORY Clamps-Bulldog	141
Ecarteurs à scapula	73	H	
Ecarteurs autostatiques	78-79	HABERER Spatules abdominaux et intestinaux	69
ALLPORT	79	HALSTED Pincés hémostatiques	49,50
ALM	79	HALSTED-MOSQUITO Pincés hémostatiques	47
BECKMANN-WEITLANER	80	HARRINGTON Ecarteurs pulmonaires	71
WEITLANER	79	HARRINGTON Pincés à bronches	122
WEITLANER-BABY	79	HARTMANN Pincés à ligatures	46
Ecarteurs pour auricules cardiaques	77	HARTMANN Pincés hémostatiques	46
Ecarteurs pour l'aorte	76	HARTMANN-MICRO Pincés hémostatiques	46
CRAWFORD	77	HEANEY Portes-aiguilles	84
ROSS	76	HEGEMANN Ciseaux vasculaires	18
Ecarteurs pulmonaires	70-75	HEISS Pincés hémostatiques	50
ALLISON	72	HENLY Clamps non-traumatisants	170
DEAVER	70		
HARRINGTON	71	I	
Ecarteurs Thoraciques-sternaux	109-119	INTRACARDIAC Portes-aiguilles	87
BURFORD	117	IRIS Ciseaux	8,21
BURFORD-FINOCHIETTO	117		
CASTANEDA	115	J	
COOLEY	111	JAMESON Ciseaux fins à dissection	16
COOLEY "XL"	111	JAVID Pincés-Clamps pour la carotide	131
DE BOER	118	JEU pour tunneler complet	174
DEBAKEY	109-110,118	JOHN-HOPKINS Pincés à appliquer	45
FINOCHIETTO	112,116	JUDD-ALLIS Pincés à préhension	60
FINOCHIETTO-BABYHAIGHT	112,113	JULIAN Portes-aiguilles	82
FINOCHIETTO-Modifié	113		
MERCEDES	119	K	
MORSE-COOLEY	112	KADER Spatules abdominaux et intestinaux	69
MORSE-FAVOLORO	114	KANTROWITZ Pincés à dissequer	56
MORSE-STERNAL	114	KELLY Ciseaux fins	11
TUFFIER	116	KELLY Ciseaux fins SUPERCUT	11
Elevateurs	93-94	KELLY Pincés hémostatiques	47,55
ALDERDYCE	93	KELLY Pincés hémostatiques TITAN	47
COBB	93	KELLY-RANKIN Pincés hémostatiques	48
KEY	94	KEY Elevateurs	94
LANGENBECK	93	KILNER Portes-aiguilles	81
QUERVAIN	93	KIRKLIN Crochets pour veines malleables	63
Endarterectomie, strippers	176	KIRMISSION Rugines	94
		KLAPP Ecarteurs à tendons	64
F		KLINGENBERG-LOTH Ciseaux à dissection	13
FARABEUF Daviers	99	KOCHER Ecarteurs	66,67
FARABEUF Rugines	94	KOCHER Pincés hémostatiques	52
FARABEUF-COLLIN Rugines	94	KOCHER-FINO Pincés hémostatiques	52
FARABEUF-LAMBOTTE Daviers	99	KÖNIG Ecarteurs pour veines	64
FAVALORO Ciseaux vasculaires	19		
FAVALORO Ecarteurs autostatiques	121	L	
FAVALORO-OCHSNER Ecarteurs autostatiques	121	LAHEY-METZENBAUM Ciseaux à dissection	15
FERGUSSON Daviers	99	LAMBERT-KAY Clamps pour anastomoses à l'aorte	160
FERRIS-SMITH Pincés à dissequer	29	LAMBOTTE Rugines	95
FINOCCHIETTO Pincés à bronches et à ligatures	122	Lames de bistouri	1-2,6
FINOCCHIETTO Portes-aiguilles	82	Lames de Rasoir	7
		LANE Pincés à dissequer	32
G		LANGENBECK Daviers	99
GARRETT Dilatateurs vasculaires	173	LANGENBECK Elevateurs	93
GEMINI Pincés hémostatiques	56	LANGENBECK Portes-aiguilles	84
GEMINI-MINI Pincés hémostatiques	56	LANGENBECK Rugines	94
GERALD Pincés à dissequer	26,30	LEBSCHE Cisaille à sternum	108
GERALD Pincés non-traumatisants PROMEDUR	37	LEBSCHE Sternotome	108
GILLIES Crochets à peau	63	LEES Clamps non-traumatisants	168
GILLIES Pincés à dissequer	28	LELAND-JONES Clamps non-traumatisants	152
GILLIES Pincés à dissequer TITAN	28	LEMMON Rapprocheurs des côtes	120
GILLIES Portes-aiguilles	86	LEMMON Spatules vasculaires	175
GIL-VERNET Ecarteurs	65	LERCHE Pincés à dissequer	31
GLOVER Clamps non-traumatisants	165,166	LERICHE Pincés hémostatiques	48
GLOVER Clamps-Bulldog	140	LEXER-BABY Ciseaux fins à dissection	15,21
GLUCK Costotome	106	LICHTENBERG Portes-aiguilles	85
GOELET Ecarteur	65	LOCKWOOD Pincés à préhension	60
GOLDMAN-FOX Ciseaux fins à dissection PROMEDUR	21		
GORNEY Ciseaux fins à dissection	20		
GRAEFE Pincés fines à dissequer	25,28		
GREEN Ecarteurs	68		

	Page		Page
LOVELACE Pincés à préhension	123		
LOVELACE Pincés hémostatiques	48		
M			
Manches pour lames de bistouri	3-6		
Manches pour microbistouris	6		
MARQUARDT Pince-Gouge	101		
MASSON Portes-aiguilles	83		
MATHIEU Portes-aiguilles	85		
MATHIEU-KOCHER Portes-aiguilles	85		
MATSON Périostotome	97		
MATSON-ALEXANDER Rugines	95		
MAYFIELD Pince-Gouge	101		
MAYO Ciseaux à dissection	12,22		
MAYO Ciseaux à dissection PROMEDUR	22		
MAYO Ciseaux à dissection SUPERCUT	12		
MAYO-HARRINGTON Ciseaux à dissection PROMEDUR	22		
MAYO-HEGAR Portes-aiguilles	81		
MAYO-LEXER Ciseaux à dissection PROMEDUR	22		
MAYO-RUSSIAN Pincés à disséquer	32		
MAYO-STILLE Ciseaux à dissection	12,22		
MAYO-STILLE Ciseaux à dissection PROMEDUR	12		
McINDOE Pincés à disséquer	25		
McINDOE Pincés à disséquer TITAN	25		
MEEKER Pincés hémostatiques	57		
METZENBAUM Ciseaux à dissection	14,23		
METZENBAUM Ciseaux à dissection SUPERCUT	14		
METZENBAUM-BABY Ciseaux à dissection	13		
METZENBAUM-BABY Ciseaux à dissection SUPERCUT	13		
METZENBAUM-FINO Ciseaux à dissection	14,24		
METZENBAUM-FINO Ciseaux à dissection PROMEDUR	24		
METZENBAUM-FINO Ciseaux à dissection SUPERCUT	14		
METZENBAUM-X-FINO Ciseaux à dissection PROMEDUR	14		
METZENBAUM Ciseaux à dissection PROMEDUR	24		
MICRO Pincés à disséquer	27,35,179		
MICRO PORTES-AIGUILLES avec manche-profil	184-185		
MICRO-CISEAUX avec manche-profil	180-182		
MICRO-CISEAUX avec manche-profil NAGEL	182		
MICRO-CISEAUX avec manche-profil VANNAS	181		
Micro-Clips	45,144,185		
Micro-Lames de bistouri	6		
MICRO-MOSQUITO Pincés hémostatiques	47		
Micro-Pincettes à dissection avec manche-profil	179		
MICRO-VASCULAR Portes-aiguilles	82		
MIDDELDORPF Ecarteurs	67,68		
MINI-RYDER Portes-aiguilles	86		
Mini-Serrefines	46		
MIXTER Ciseaux opératoires délicats	11		
MIXTER Pincés hémostatiques	57		
MIXTER-O'SHAUGHNESSY Pincés hémostatiques	54		
MOBERG Ecarteurs	63		
MORRIS Ecarteur vasculaire	178		
MORSE Ecarteurs	66		
MOSQUITO Pince hémostatiques pour MAIN GAUCHE	46		
MOSQUITO Pincés hémostatiques TITAN	47		
N			
NABATOFF Trousse pour varices	92		
NEIVERT Portes-aiguilles	81		
NELSON Pincés à disséquer	31		
NEONATAL Clamps pour nouveaux-nés et enfants	136		
O			
OCHSNER-KOCHER Pincés hémostatiques	53		
OEHLER Pincés non-traumatisants PROMEDUR	37		
OLSEN-HEGAR Portes-aiguilles	86		
OVERHOLT Périostotomes	97		
OVERHOLT-BABY Pincés hémostatiques 14 cm	54		
OVERHOLT-GEISSENDOERFER Pincés hémostatiques	54		
P			
PEAN-FINO Pincés hémostatiques	51		
PEAN-ROCHESTER Pincés hémostatiques	51		
PERFORATEURS pour aorte	177		
Périostotomes	97		
Pince à appliquer JOHN-HOPKINS	45		
SCHWARTZ	46		
Pince pour poser Micro-Clips	45,185		
Pincés à bronches	122,123		
Pincés à coagulation bipolaire	38-42		
Pincés à disséquer	25-37		
ADLERKREUZ	31		
ADSON	25,28,36		
ADSON-BROWN	31,37		
ADSON-DEBAKEY	28		
ADSON-GRAEFE	28		
ADSON-MICRO	25,28		
BLANK	25		
BONNEY	31,37		
BROPHY	25,29		
BROWN	31		
COLLIN-DUVAL	33		
COOLEY	35		
CUSHING	26,30,36		
DEBAKEY	34-35,37		
DEBAKEY-GERALD	26		
DUEHRSSSEN	26,30		
DURANTE	33		
DUVAL	33		
FERRIS-SMITH	29		
FINO	25		
GERALD	26,30,37		
GILLIES	28		
GRAEFE	25,28		
LANE	32		
LERCHE	31		
MAYO-RUSSIAN	32		
McINDOE	25		
MICRO	27,179		
NELSON	31		
OEHLER	37		
POTTS-SMITH	26,30,36		
RUSSIAN	32		
SINGLEY(Tuttle)	32		
STILLE-BARRAYA	32		
STONE	31		
WANGENSTEEN	32,36		
WAUGH	27,33		
FINO	25,29		
non-traumatisants	25,34-37		
pour micro-chirurgie	27,35,179		
TITAN	25,26,28,34,35		
Pincés à poser ACLAND-Modif. Micro-Clamps	185		
Pincés à préhension	58-62,123		
ALLIS	59		
ALLIS-ADAIR	59		
ALLIS-BABY	59		
BABCOCK	60		
BABCOCK PROMEDUR	61		
BABCOCK-DEBAKEY	61		
BABY-ALLIS	59		
BOYS-ALLIS	60		
COLLIN	62		
DEBAKEY	58		
DEBAKEY-BABCOCK	61		
DEBAKEY-DUVAL	62		
DEBAKEY-WERTHEIM	58		
DICK	58		
DUVAL	62		
DUVAL PROMEDUR	62		
DUVAL-DEBAKEY	62		
JUDD-ALLIS	60		
LOCKWOOD	60		

	Page		Page
THOMS-ALLIS	60	POLLOSON Ecarteurs	74-75
WERTHEIM-DEBAKEY	58	POOLE Canules à aspiration	89
WILLIAMS	60	Portes-aiguilles	81-87,182-183
Pincés coupantes pour os	104-106	BABY-CRILE-WOOD	81
RUSKIN-LISTON	104	BERRY STERNAL	82
STILLE-HORSLEY	105	BOZEMANN	83
STILLE-LISTON	104	CASTROVIEJO	87
Pincés fines à dissequer	25-28	CRILE-WOOD	81
Pincés hémostatiques ADSON	49,50	DEBAKEY	82
ADSON-BABY	50	DIETHRICH	87
BABY-ADSON	50	FINOCHIETTO	82
BABY-CRILE	48	GILLIES	85
BABY-MIXTER	57	HEANEY	84
BABY-OVERHOLT	54	INTRACARDIAC	87
BENGOLEA	50	JULIAN	82
BRIDGE	50	KILNER	81
CRAFOORD	51	LANGENBECK	84
CRAFOORD-SELLORS	52	MASSON	83
CRILE	48	MICRO	183-184
CRILE-RANKIN	49	MICRO-VASCULAR	82
DANDY	48	MICRO-VASCULAR	82
DIEFFENBACH	45	NEIVERT	81
GEMINI	56	OLSEN-HEGAR	85
GEMINI-MINI	56	RYDER	85
HALSTED-MOSQUITO	47,48	RYDER-MINI	85
HALSTED-MOSQUITO	49	SAROT	84
HARTMANN	47	STRATTE	84
HARTMANN-MICRO	47	WANGENSTEEN	83
HEISS	50	POST-MORTEM Lames de bistouri	2
JOHNS-HOPKINS	45	POTTS Ciseaux fins à dissection	10
KANTROWITZ	56	POTTS Clamps non-traumatisants	165
KELLY	48,55	POTTS-DE-MARTEL Ciseaux vasculaires	20
KELLY-RANKIN	48	POTTS-SMITH Ciseaux vasculaires	18,21
KOCHER	52	POTTS-SMITH Ciseaux vasculaires PROMEDUR	24
KOCHER-FINO	52	POTTS-SMITH Ciseaux vasculaires SUPERCUT	18
LERICHE	48	POTTS-SMITH Pincés à dissequer	26,30,36
LOVELACE	48	PRICE-THOMAS Pincés à bronches	122
MEEKER	57	PROVIDENCE-HOSPITAL Pincés hémostatiques	47
MICRO	45		
MICRO-MOSQUITO	48		
MINI	47		
MIXTER	57		
MIXTER-BABY	57		
MIXTER-O'SHAUGHNESSY	54		
OCHSNER-KOCHER	53		
OVERHOLT-BABY	54		
OVERHOLT-HEISSENDOERFER	54		
OVERHOLT-MIXTER	54		
PEAN-FINO	51		
PROVIDENCE-HOSPITAL	48		
RANKIN-CRILE	49		
RANKIN-KELLY	48		
ROBERTS	51		
ROCHESTER-CARMALT	51		
ROCHESTER-OCHSNER	53		
ROCHESTER-PEAN	51		
RUMEL	56		
SAROT	52		
SCHWARTZ	46		
WIKSTROEM	57		
ZENKER	52		
Pincés Micro à dissequer	27,179		
Pincés-Gouges	101-103		
BEYER	101		
MARQUARDT	101		
MAYFIELD	101		
RUSKIN	101		
SAUERBRUCH	103		
SMITH-PETERSEN	102		
STILLE	102		
STILLE-LUER	102		
STILLE-RUSKIN	102		
ZAUFAL-JANSEN	101		
Pincés-perforatrice pour valve	177		
POIDS PLUME Clamps-Bulldog	143		
		Q	
		QUERVAIN Elevateurs	93
		R	
		RAGNELL Ecarteurs	65
		RANKIN-CRILE Pincés hémostatiques	49
		RANKIN-KELLY Pincés hémostatiques	48
		Rapprocheurs des côtes	120
		Raspatoires	94-98
		ALEXANDER	95
		CUSHING	98
		DAVIDSON-ALEXANDER	96
		DOYEN	96
		FARABEUF	94
		FARABEUF-COLLIN	94
		KEY	94
		KIRMISSION	94
		LAMBOTTE	95
		LANGENBECK	94,95
		MATSON	97
		MATSON-ALEXANDER	95
		OVERHOLT	97
		SCHNEIDER	95
		SCHNEIDER-SAUERBRUCH	95
		SEDILLOT	96
		SEMB	97
		REVERDIN Spatules abdominaux et intestinaux	69
		REYNOLDS Ciseaux fins à dissection	16
		ROBB Dissecteurs vasculaires	175
		ROBERTS Pincés hémostatiques	51
		ROCHESTER-CARMALT Pincés hémostatiques	51
		ROCHESTER-OCHSNER Pincés hémostatiques	53
		ROCHESTER-PEAN Pincés hémostatiques	51

	Page		Page
Rugines	94-98	V	
RUMEL Pincés hémostatiques	56	Varices, Trousse pour	92
RUMEL-BELMONT Tourniquets	177		
RUSKIN Pincés-gouges	101	W	
RUSKIN-LISTON Pincés coupantes pour os	104	WALKER Ciseaux fins à dissection	8
RUSSIAN Pincés à dissequer	32	WALTON Strippers pour endarterectomie	176
RYDER Portes-aiguilles	86	WANGENSTEEN Pincés à dissequer	31,36
RYDER-MINI Portes-aiguilles	86	WANGENSTEEN Pincés à dissequer PROMEDUR	36
		WANGENSTEEN Portes-aiguilles	83
S		WASSMUND Ecarteurs	66
SANTULLI Clamps-Bulldog	142	WAUGH Pincés à dissequer	27,33
SAROT Clamps bronchique	52	WEBER Clamps pour anastomose de l'aorte	157
SAROT Portes-aiguilles	84	WEITLANER Ecarteurs autostatiques	79-80
SATINSKY Ciseaux pour la veine cave	13	WEITLANER-BABY Ecarteurs	79
SATINSKY Clamps non-traumatisants	160	WERTHEIM Ciseaux à dissection	12
SAUERBRUCH Costotome	107	WERTHEIM-DEBAKEY Clamps à compression	58
SAUERBRUCH Pincés-Gouges	103	WICKHAM Clamps-Bulldog	143
SAUERBRUCH-FREY Costotome	108	WICKHAM Pince à poser les Clamps-Bulldog	143
SCHMID Canules pour lavage	173	WIKSTROEM Pincés hémostatiques	57
SCHMID Spatules vasculaires	175	WILLIAMS Pincés à préhension	60
SCHNEIDER Rugine	95	WYLIE Clamps abdomineaux	172
SCHNEIDER-SAUERBRUCH Rugine	95	WYLIE Clamps anastomose de l'aorte	159
SCHUMACHER Cisaille à sternum	108		
SCHWARTZ Clips hémostatiques	46	Y	
SCHWARTZ Pince à appliquer	46	YANKAUER Canules à aspiration	89
SEDILLOT Raspatoires	96		
SELLORS Rapprocheurs des côtes	120	Z	
SEMB Costotome	107	ZAUFAL-JANSEN Pince-gouge	101
SEMB Daviers	99	ZENKER Ecarteurs	68
SEMB Pince à ligatures	123	ZENKER Pincés hémostatiques	52
SEMB Pincés à bronches	123		
SEMB Raspatoires	97		
SIMS Ciseaux à dissection PROMEDUR	22		
SINGLEY (Tuttle) Pincés à dissequer	32		
SMITH-PETERSON Pincés-Gouges	102		
Spatules abdominaux et intestinaux	69		
Spatules vasculaires	175		
Sternotome	108		
STEVENS Ciseaux fins à ténotomie	9		
STILLE Costotome	106		
STILLE Pince gouge	102		
STILLE-BARRAYA Pincés à dissequer	32		
STILLE-GIERTZ Costotome	107		
STILLE-HORSLEY Costotome	105,107		
STILLE-LISTON Pincés coupantes pour os	104		
STILLE-LUER Pincés-Gouges	102		
STILLE-RUSKIN Pince-Gouge	102		
STONE Pincés à dissequer	31		
STRABISMUS Ciseaux	9		
STRATTE Portes-aiguilles	84		
SUPERLEGER Clamps-Bulldog	143		
T			
THOMS-ALLIS Pincés à préhension	60		
THOREK (HALLE) Ciseaux à dissection	13		
THOREK Ciseaux pour le poumon	13		
TITANIUM Clamps-Bulldog	144		
TITANIUM Micro-Pincettes	35		
TOENNIS Ciseaux à dissection	15		
TOENNIS-ADSON Ciseaux à dissection	15,22		
Tourniquets	177		
TROUTMAN Portes-lames	7		
TUBBS Dilatateurs aortique	178		
Tubes à aspiration	89		
TUFFIER Spatules abdominaux et intestinaux	69		
U			
ULRICH Daviers	100		
UNIVERSAL Ciseaux coupe-fils et ligatures PROMEDUR	24		

INDICE ALFABÉTICO**A**

ACLAND-mod. Aproximadores	185
ACLAND-mod. Micro-Clamps doble	185
ACLAND-mod. Micro-Clamps vasculares	185
ADSON Pinzas de disección con dientes	28
ADSON Pinzas de disección con dientes TITANIO	28
ADSON Pinzas de disección con fillos T.C.	36
ADSON Pinzas finas de disección	25
ADSON Pinzas hemostáticas	49,50
ADSON-BABY Pinzas hemostáticas	50
ADSON-BABY Separadores	80
ADSON-BROWN Pinzas de disección con fillos T.C.	37
ADSON-DEBAKEY Pinzas de disección atraumáticas	28
ADSON-GRAEFE Pinzas de disección con dientes	28
ADSON-MICRO Pinzas de disección con dientes	28
ADSON-MICRO Pinzas finas de disección	25
Agujas de guía	91
ALDERDYCE Elevador para huesos	93
ALEXANDER Legras-Periostótomos	95
ALLIS Pinza atraumáticas	59
ALLIS Pinzas para tejidos y órganos	59
ALLIS-ADAIR Pinzas para tejidos y órganos	59
ALLIS-BABY Pinzas para tejidos y órganos	59
ALLISON Espátulas para el pulmón	72
ALLPORT Separador	79
ALM Separadores	79
ANATOMIA Tijeras finas para cirugía	9
ANDREW-PYNCHON Tubos de aspiración	89
Aproximadores para costillas	120
ARTERIOTOMIA Tijeras vasculares	18

B

BABCOCK Pinzas para tejidos y órganos	60-61
BABCOCK Pinzas para tejidos y órganos con fillos T.C.	61
BABCOCK-DEBAKEY Pinzas para tejidos y órganos	61
BABY-ADSON Pinzas hemostáticas	50
BABY-ADSON Separadores	80
BABY-ALLIS Pinzas para tejidos y órganos	59
BABY-CRILE Pinzas hemostáticas	48
BABY-CRILE-WOOD Porta-agujas con fillos T.C.	81
BABY-MIXTER Pinzas hemostáticas	57
BABY-OVERHOLT Pinzas hemostáticas	54
BABY-WEITLANER Separadores	79
BAILEY Aproximadores para costillas	120
BAILEY Pinzas-perforadores para valva aortica	177
BAILEY-BABY Aproximadores para costillas	120
BAILEY-GIBBON Aproximadores para costillas	120
BARRAQUER Pinzas para sujetar y romper hojas de afeitar	7
BARRON Mangos de bisturíes	6
BECKMANN-WEITLANER Separadores	80
BENGOLEA Pinzas hemostáticas	50
BERRY-STERNAL Porta-agujas con fillos T.C.	82
BETHUNE Costótomos	107
BEYER Pinzas-gubias	101
Bisturí, hojas de	1-2,6
BLANK Pinzas atraumáticas	25
BONNEY Pinzas de disección con fillos T.C.	37
BOWMAN Tijeras vasculares	17
BOYS-ALLIS Pinzas para tejidos y órganos	60
BOZEMANN Porta-agujas con fillos T.C.	83
BRIDGE Pinzas de disección y ligaduras	50
BROM Ganchos para venas	63
BROPHY Pinzas de disección	25
BROPHY Pinzas de disección con dientes	29
BRUNNER Costótomos	108
BURFORD Separadores costales	117
BURFORD-FINOCHIETTO Separadores costales	117

C

Cables de conexión para pinzas de coagulación	43
CANNON Juego para endarterectomía	176
Cánulas vasculares para irrigación	173
CASTANEDA Pinzas para recién nacidos y niños	137,139
CASTANEDA Separadores costales	115
CASTROVIEJO Pinzas para sujetar y romper hojas de afeitar	7
CASTROVIEJO Porta-agujas con fillos T.C.	87
CASTROVIEJO Porta-hojas 13 cm	7
Clamps Bulldog	45
Clamps Bulldog atraumáticas	140-147
Clamps-Bulldog TITANIO	144
COAGULACIÓN bipolar, Pinzas para	38-42
COBB Elevadores para huesos	93
COLLIN Mangos de bisturíes	4
COLLIN Pinzas para tejidos y órganos	62
COOLEY "XL" Separadores costales	111
COOLEY Clamps-Bulldog	129
COOLEY Dilatador de aorta	178
COOLEY Pinzas patente de conducto	127,130
COOLEY Pinzas-Clamps para anastomosis	124,126,128,135
COOLEY Pinzas-Clamps para aorta	133
COOLEY Pinzas-Clamps para coarctación	127,130
COOLEY Pinzas-Clamps para la arteria iliaca	133
COOLEY Pinzas-Clamps para las arterias renales	127,128
COOLEY Pinzas-Clamps para ligaduras	128
COOLEY Pinzas-Clamps para multiple propósito	125,129,131,133,134,135
COOLEY Pinzas-Clamps para oclusión tangencial	132
COOLEY Pinzas-Clamps para oclusión vena-cava	132
COOLEY Separadores costales	111
COOLEY Separadores para auricula	77
COOLEY Tubos de aspiración	90
COOLEY-BABY Pinzas para recién nacidos y niños	138
COOLEY-BECK Pinzas-Clamps para anastomosis	128
COOLEY-DERRA Pinzas-Clamps para anastomosis	124
COOLEY-PARRY Pinzas-Clamps para anastomosis	135
COOLEY-SATINSKY Pinza-Clamp para anastomosis	124
CORYLLOS-BETHUNE Costótomos	107
Costótomos	105-108
CRAFOORD Pinzas hemostáticas	51
CRAFOORD Tijeras torácicas	17
CRAFOORD-SELLORS Pinzas para la auricula atril	52
CRAWFORD Separadores para aorta	77
CRILE Pinzas hemostáticas	48,55
CRILE Pinzas hemostáticas TITANIO	48
CRILE-BABY Pinzas hemostáticas	48
CRILE-RANKIN Pinzas hemostáticas	49
CRILE-WOOD Porta-agujas con fillos T.C.	81
CRILE-WOOD-BABY Porta-agujas con fillos T.C.	81
CUSHING Periostótomos	98
CUSHING Pinzas de disección con dientes	30
CUSHING Pinzas de disección con fillos T.C.	36
CUSHING Separadores para venas	64

D

DANDY Pinzas hemostáticas	48
DARDICK Pinzas-Clamps de multiple propósito	134
DAVIDSON Separadores para scapula	73
DAVIDSON-ALEXANDER Legras-Periostótomos	96
DE BOER Separadores costales	118
DEAVER Espátulas para el pulmón	70-73
DEAVER Tijeras finas para cirugía	10
DEBAKEY Clamps-Bulldog	145
DEBAKEY Dilatadores vasculares	173
DEBAKEY Micro-Pinzas de disección	35
DEBAKEY Micro-Pinzas de disección TITANIO	35
DEBAKEY Pinza-Clamp para arterias renales	151
DEBAKEY Pinza-Clamps de disección torácica	168
DEBAKEY Pinza-Clamps para coarctación	167
DEBAKEY Pinza-Clamps para ligaduras	169
DEBAKEY Pinzas atraumáticas	34
DEBAKEY Pinzas atraumáticas TITANIO	34

	Página		Página
DEBAKEY Pinzas de disección con fillos T.C.	37	FAVALORO Separadores autostaticos	121
DEBAKEY pinzas de disección TITANIO	34	FAVALORO Tijeras vasculares	19
DEBAKEY Pinzas para tejidos y organos	58	FAVALORO-OCHSNER Separadores autostaticos	121
DEBAKEY Pinzas-Bulldog	146	FERGUSON Pinzas para coger huesos	99
DEBAKEY Pinzas-Clamps de aneurisma aortica	153-155	FERRIS-SMITH Pinzas de disección con dientes	29
DEBAKEY Pinzas-Clamps de conducto vascular	150,152-153	FINOCCHIETTO Pinzas para bronquios y pulmon	122
DEBAKEY Pinzas-Clamps para coarctación y patente de conducto	149,165,167	FINOCH.-BABY-HAIGHT Separadores costales	112,113
DEBAKEY Pinzas-Clamps para vasos periféricos	150,152-153	FINOCHIETTO Porta-agujas con fillos T.C.	82
DEBAKEY Porta-agujas con fillos T.C.	82	FINOCHIETTO Separadores costales	112,116
DEBAKEY Separadores costales	109	FINOCHIETTO-MODIF. Separadores costales	113
DEBAKEY Tijeras para preparaciones	15		
DEBAKEY Tijeras vasculares	19,24	G	
DEBAKEY Tubos de aspiración	89	Ganchos	63
DEBAKEY-ADSON Pinzas de disección con dientes	28	GARRETT Dilatadores vasculares	173
DEBAKEY-BABCOCK Pinzas para tejidos y organos	61	GEMINI Pinzas para preparaciones y ligaduras	56
DEBAKEY-BAHNSON Pinzas-Clamps para aorta	156-159	GEMINI-MINI Pinzas para preparaciones y ligaduras	56
DEBAKEY-BAINBRIDGE Pinzas-Clamps vasculares	151	GERALD Pinzas de disección	26
DEBAKEY-BECK Pinza-Clamps para aorta	170	GERALD Pinzas de disección con dientes	30
DEBAKEY-BECK Pinzas-Clamps para anastomosis	171	GERALD Pinzas de disección con fillos T.C.	37
DEBAKEY-BECK Pinzas-Clamps para aorta y coarctación	165	GILLIES Ganchos finos	63
DEBAKEY-CAROTID Clamps-Bulldog	147	GILLIES Pinzas de disección con dientes	28
DEBAKEY-DALE Pinzas-Clamps para vasos periféricos	153	GILLIES Pinzas de disección con dientes TITANIO	28
DEBAKEY-DERRA Pinzas-Clamps para anastomosis	170	GILLIES Porta-agujas con fillos T.C.	86
DEBAKEY-DIETRICH Pinzas-Clamps para aorta	152	GIL-VERNET Separadores para venas y hilares	65
DEBAKEY-GERALD Pinzas de disección atraumaticas	26	GLOVER Clamps-Bulldog	140
DEBAKEY-GLOVER Pinzas-Clamps para coarctación	170	GLOVER Pinzas-Clamps para anastomosis	166
DEBAKEY-GLOVER Pinzas-Clamps para ductus	169	GLOVER Pinzas-Clamps vasculares	165
DEBAKEY-GREGORY Pinzas-Clamps de aneurisma aortica	153	GLUCK Costótomos	106
DEBAKEY-HARKEN Pinzas-Clamps para tórax y auricula	164	GOELET Separador	65
DEBAKEY-LAMBERT Pinzas-Clamps para anastomosis de aorta	160	GOLDMAN-FOX Tijeras finas para cirugía	21
DEBAKEY-MICRO Clamps-Bulldog	145	GORNEY Tijeras torácicas	20
DEBAKEY-MORRIS Pinzas-Clamps para aorta	162	GRAEFE Pinzas de disección con dientes	28
DEBAKEY-MOSQUITO Pinzas atraumaticas	148	GRAEFE Pinzas finas de disección	25
DEBAKEY-OCHSNER Pinzas-Clamps para aorta	152	GREEN Separador	68
DEBAKEY-PEAN Pinzas atraumaticas	148	GREGORY Clamps-Bulldog	141
DEBAKEY-REYNOLDS Pinzas-Clamps para anastomosis	171		
DEBAKEY-SATINSKY Clamps-Bulldog	147	H	
DEBAKEY-SATINSKY Pinzas-Clamps para la vena cava	163	HABERER Espátulas	69
DEBAKEY-WERTHEIM Pinzas para tejidos y organos	58	HALSTED Pinzas hemostáticas	49
DEMARTELL Tijeras vasculares	20	HALSTED-MOSQUITO Pinzas hemostáticas	46
DICK Pinzas para tejidos y organos	58	HARRINGTON Espátulas para el pulmón	71
DIEFFENBACH Clamps Bulldog	45	HARRINGTON Pinzas para bronquios y pulmon	122
DIETHRICH Pinzas-Clamps de aneurisma aortica	158	HARTMANN Pinzas hemostáticas	46
DIETHRICH Porta-agujas con fillos T.C.	87	HEANEY Porta-agujas con fillos T.C.	84
DIETHRICH Tijeras vasculares	18	HEGEMANN Tijeras vasculares	18
DIETRICH Clamps-Bulldog	142	HEISS Pinzas hemostáticas	50
Dilatadores de aorta	178	HENLY Pinzas-Clamps para anastomosis	170
Dilatadores vasculares 1	73	Hojas de afeitar	7
Disecadores vasculares 175		Hojas de bisturís	1-2,6
DOYEN Legras-Periostótomos	96	Hojas de bisturís POST-MORTEM	2
DUEHRSEN Pinzas de disección	26	Hojas de micro bisturís	6
DUEHRSEN Pinzas de disección con dientes	30		
DUVAL Pinzas para tejidos y organos	62	I	
DUVAL Pinzas para tejidos y organos atraumaticas	62	INTRACARDIAC Porta-agujas con fillos T.C.	87
DUVAL Pinzas para tejidos y organos con fillos T.C.	62		
		J	
E		JAMESON Tijeras para disección y preparaciones	16
Elevadores para huesos	93,94	JAVID Pinzas-Clamps para la carótide	131
Endarterectomia	176	JOHN-HOPKINS Clamps Bulldog	45
Espátulas	69-75	JUDD-ALLIS Pinzas para tejidos y organos	60
Espátulas abdominal e intestinal	69	JUEGO para tunelar	174
Espátulas para el pulmón	70	Juego para várices	92
Espátulas pulmonares y para aorta	74-75		
Espátulas vasculares	175	K	
Espátulas y dilatadores para la intima	175	KADER Espátulas	69
		KANTROWITZ Pinzas hemostáticas	56
F		KELLY Pinzas hemostáticas	47
FARABEUF Periostótomos	94		
FARABEUF Pinzas para coger huesos	99		
FARABEUF-COLLIN Periostótomos	94		
FARABEUF-LAMBOTTE Pinzas para coger huesos	99		

	Página		Página
KELLY Pinzas hemostáticas TITANIO	47	MIXTER Tijeras finas para cirugía	11
KELLY Tijeras finas para cirugía	11	MIXTER-BABY Pinzas hemostáticas	57
KELLY-RANKIN Pinzas hemostáticas	48	MIXTER-O'SHAUGHNESSY Pinzas hemostáticas	54
KEY Elevadores para huesos	94	MOBERG Separadores	63
KILNER Porta-agujas con fillos T.C.	81	MORRIS Separador vascular	178
KIRKLIN Separadores para venas maleables	63	MORSE (LOVE) Separadores	66
KIRMISSION Periostótomo	94	MORSE-COOLEY Separadores costales	112
KLAPP Separadores	64	MORSE-FAVALORO Separadores costales	114
KLINGENBERG-LOTH Tijeras vasculares	13	MORSE-STERNAL Separadores costales	114
KOCHER Pinzas hemostáticas	52	MOSQUITO Pinzas hemostáticas para MANO IZQUIERDA	46
KOCHER Separadores	66,67	MOSQUITO-MICRO Pinzas hemostáticas	47
KOCHER-FINO Pinzas hemostáticas	52	MUY LIGERO Clamps-Bulldog	143
KÖNIG Separadores para venas	64,65		
L			
LAHEY-METZENBAUM Tijeras para preparaciones	15	NABATOFF Juego para várices	92
LAMBOTTE Legras-Periostótomos	94,95	NAGEL Micro-Tijeras con mango "PERFIL"	182
LANGENBECK Porta-agujas con fillos T.C.	84	NEIVERT Porta-agujas con fillos T.C.	81
LANGENBECK Elevadores para huesos	93	NEONATAL Pinzas para la pediatría	136
LANGENBECK Pinzas para coger huesos	99		
LEBSCHÉ Cinceles de esternón	108	O	
LEBSCHÉ Tijeras de esternón	108	OCHSNER-KOCHER Pinzas hemostáticas	53
LEES Pinzas-Clamps bronquiales	168	OEHLER Pinzas de disección con fillos T.C.	37
Legras-Periostótomos	95-97	OLSEN-HEGAR Porta-agujas con fillos T.C.	86
LELAND-JONES Pinzas-Clamps para vasos periféricos	152	OVERHOLT Elevadores	97
LEMMON Aproximadores para costillas	120	OVERHOLT-BABY Pinzas hemostáticas	54
LEMMON Discadores vasculares	175	OVERHOLT-GEISSENDOERFFER Pinzas para preparaciones	54
LERICHE Pinzas hemostáticas	48	OVERHOLT-MIXTER Pinzas para preparaciones y ligaduras	54
LEXER-BABY Tijeras finas para preparaciones	15		
LICHTENBERG Porta-agujas con fillos T.C.	85	P	
LOCKWOOD Pinzas para tejidos y organos	60	PEAN-FINO Pinzas hemostáticas	51
LOVE (Morse) Separadores	66	PERFORADORES para aorta	177
LOVELACE Pinzas hemostáticas	48	Periostótomos	94,95
LOVELACE Pinzas para coger el pulmon	123	Pinza atraumaticas	25,34-35
		Pinzas cortantes para huesos	104-106
M		Pinzas de disección	25-27,36-37
Mangos de bisturíes	3-6	Pinzas de disección atraumaticas	34-35
Mangos de bisturíes para micro bisturíes	6	Pinzas de disección con dientes	28-32
MARQUARDT Pinzas-gubias	101	Pinzas de disección con fillos T.C.	36-37
MARTMANN-MICRO Pinzas hemostáticas	46	Pinzas de disección y ligaduras	50-52,54-57
MASSON Porta-agujas con fillos T.C.	83	Pinzas hemostáticas	46-57
MATHIEU Porta-agujas con fillos T.C.	85	Pinzas para aplicar Clamps Acland	185
MATHIEU-KOCHER Porta-agujas con fillos T.C.	85	Pinzas para bronquios y pulmon	122
MATSON Legras-Periostótomos	97	Pinzas para coagulación bipolar	38-42
MATSON-ALEXANDER Legras-Periostótomos	95	Pinzas para coger el pulmon	123
MAYFIELD Pinzas-gubias	101	Pinzas para coger huesos	99-100
MAYO Tijeras para disección y preparaciones con fillos T.C.	12,22	Pinzas para la pediatría 1	24-127,136-139
MAYO-HARRINGTON Tijeras para cirugía con fillos T.C.	22	Pinzas para poner Serra-finas	45
MAYO-HEGAR Porta-agujas con fillos T.C.	81	Pinzas para sujetar y romper hojas de afeitar	7
MAYO-LEXER Tijeras para preparaciones con fillos T.C.	22	Pinzas para tejidos y organos	58-62
MAYO-STILLE Tijeras para disección y preparaciones con fillos T.C.	12,22	Pinzas-Clamps bronquiales	168
McINDOE Pinzas de disección	25	Pinzas-Clamps de aneurisma aortica	153-155
MEEKER Pinzas para preparaciones y ligaduras	57	Pinzas-Clamps de conducto vascular	150,152-153
MERCEDES Separadores costales	119	Pinzas-Clamps de disección torácica	168
METZENBAUM Tijeras para preparaciones con fillos T.C.	14,23	Pinzas-Clamps hipogastric	172
METZENBAUM-BABY Tijeras para preparaciones con fillos T.C.	13	Pinzas-Clamps para anastomosis	124,126,128,135,160,166,169,170,171
METZENBAUM-FINO Tijeras para preparaciones con fillos T.C.	14,23	Pinzas-Clamps para anastomosis de aorta	159
METZENBAUM-X-FINO Tijeras para disección con fillos T.C.	23	Pinzas-Clamps para aorta	152,156-159,162,165
MICRO Pinzas de disección	27	Pinzas-Clamps para arterias renales	151
MICRO Porta-agujas con mango "PERFIL"	183-184	Pinzas-Clamps para coarctación	127,130,149,165,167
MICRO Serra-finas	45,185	Pinzas-Clamps para la arteria iliaca	133
MICRO-ADSON Pinzas de disección con dientes	28	Pinzas-Clamps para la carótide	131
MICRO-MOSQUITO Pinzas hemostáticas	47	Pinzas-Clamps para la vena cava	163
Micro-pinzas de disección con mango "PERFIL"	179	Pinzas-Clamps para las arterias renales	127,128,151
Micro-Tijeras con mango "PERFIL"	180-182	Pinzas-Clamps para ligaduras	123,128,156
Micro-Tijeras de disección con mango "PERFIL"	180	Pinzas-Clamps para multiple propósito	125,129,131,133,134,135
MICRO-VASCULAR Porta-agujas con fillos T.C.	82	Pinzas-Clamps para oclusión tangencial	132,160
MIDDELDORPF Separades	67,68	Pinzas-Clamps para oclusión vena-cava	132
MINI-RYDER Porta-agujas con fillos T.C.	86	Pinzas-Clamps para recién nacidos y niños	124,129,136-139
MINI-Serra-finas	46	Pinzas-Clamps para tórax y auricula	164
MIXTER Pinzas hemostáticas	57		

	Página		Página
Pinzas-Clamps para vasos periféricos	150,152-153	Separadores para venas	63-66
Pinzas-Clamps patente de conducto	127,130,165	Serra-finas	45,46
Pinzas-gubias	101-103	SIMS Tijeras para cirugía	22
Pinzas-perforadores para valva aortica	177	SMITH-PETERSON Pinzas-gubias	102
POLLOSON Espátulas pulmonares y para aorta	74-75	STEVENS Tijeras finas para cirugía	9
POOLE Tubos de aspiración	89	STILLE Costótomos	106
Porta-agujas con fillos T.C.	81-88	STILLE Pinzas-gubias	102
POST-MORTEM Hojas de bisturís	2	STILLE-GIERTZ Costótomos	107
POTTS Pinzas-Clamps patente de conducto	165	STILLE-HORSLEY Costótomos	105,107
POTTS Tijeras para disección	10	STILLE-LISTON Pinzas cortantes para huesos	104
POTTS-DE-MARTEL Tijeras vasculares	7	STILLE-LUER Pinzas-gubias	102
POTTS-SMITH Pinzas de disección	26	STILLE-RUSKIN Pinzas-gubias	102
POTTS-SMITH Pinzas de disección con dientes	30	STRANDELL-STILLE Separadores	63
POTTS-SMITH Pinzas de disección con fillos T.C.	36	STRATTE Porta-agujas con fillos T.C.	84
POTTS-SMITH Pinzas de disección TITANIO	26	Strippers para endarterectomia	176
POTTS-SMITH Tijeras vasculares	18,19,24		
PRICE-THOMAS Pinzas para bronquios y pulmon	122	T	
PROVIDENCE-HOSPITAL Pinzas hemostáticas	47	THOMS-ALLIS Pinzas para tejidos y organos	60
		THOREK (HALLE) Tijeras para preparaciones	13
Q		THOREK Tijeras para preparaciones	13
QUERVAIN Separadores costales	93	Tijeras finas para cirugía	8-11,16,20,21
		Tijeras finas para cirugía con anillos grandes	8
R		Tijeras para arteriotomia	17,18
RAGNELL Separadores	65	Tijeras para disección y preparaciones	9,10,12-15,22-23
RAGNELL Tijeras finas para preparaciones	21	Tijeras torácicas y vasculares	19-20
RANKIN-CRILE Pinzas hemostáticas	49	Tijeras vasculares	13,17,18-20,24
RANKIN-KELLY Pinzas hemostáticas	48	TOENNIS Tijeras para preparaciones	15
REVERDIN Espátulas	69	TOENNIS-ADSON Tijeras para preparaciones	15,22
REYNOLDS Tijeras para disección y preparaciones	16	Tourniquetes	177
ROBB Espátulas y dilatadores para la intima	175	TROUTMAN Pinzas para sujetar y romper hojas de afeitar	7
ROBERTS Pinzas hemostáticas	51	TUBBS Dilatador de aorta	178
ROCHESTER-CARMALT Pinzas hemostáticas	51	Tubos de aspiración	89-90
ROCHESTER-OCHSNER Pinzas hemostáticas	53	TUFFIER Espátula	69
ROCHESTER-PEAN Pinzas hemostáticas	51	TUFFIER Separadores costales	116
ROSS Separadores para aorta	76	Tunelar (Juego)	174
RUMEL Pinzas para preparaciones y ligaduras	56		
RUMEL-BELMONT Tourniquetes	177	U	
RUSKIN Pinzas-gubias 101		ULRICH Pinzas para coger huesos	100
RUSKIN-LISTON Pinzas cortantes para huesos	104	UNIVERSAL Tijeras con fillos y ligaduras	24
RYDER Porta-agujas con fillos T.C.	86		
RYDER-MINI Porta-agujas con fillos T.C.	86	V	
		VANNAS Micro-Tijeras con mango "PERFIL"	181
S		Várices, Juego - NABATOFF	92
SANTULLI Clamps-Bulldog	142		
SAROT Pinzas hemostáticas	52	W	
SAROT Porta-agujas con fillos T.C.	84	WALKER Tijeras finas para cirugía	8
SATINSKY Pinzas-Clamps para oclusión tangencial	160	WALTON Strippers para endarterectomia	176
SATINSKY Tijeras vasculares	13	WANGENSTEEN Pinzas de disección con fillos T.C.	36
SAUERBRUCH Costótomos	107	WANGENSTEEN Porta-agujas con fillos T.C.	83
SAUERBRUCH Pinzas-gubias	103	WASSMUND Separadores	66
SAUERBRUCH-FREY Costótomos	108	WAUGH Pinzas de disección	27
SCHMID Cánulas vasculares para irrigación	173	WEBER Pinzas-Clamps de aneurisma aortica	157
SCHNEIDER Periostótomos	95	WEITLANER Separadores	79
SCHNEIDER-SAUERBRUCH Periostótomos	95	WEITLANER-BABY Separadores	79
SCHUMACHER Tijeras de esternón	108	WERTHEIM Tijeras para cirugía	12
SCHWARTZ Pinza para poner	46	WERTHEIM-DEBAKEY Pinzas para tejidos y organos	58
SCHWARTZ Serra-finas	46	WICKHAM Clamps-Bulldog	143
SEDILLOT Legras-Periostótomos	96	WIKSTROEM Pinzas hemostáticas	57
SELLORS Aproximadores para costillas	120	WILLIAMS Pinzas para tejidos y organos	60
SEMB Costótomos	107	WYLIE Pinzas-Clamps hipogastric	172
SEMB Legras-Periostótomos	97	WYLIE Pinzas-Clamps para anastomosis de aorta	159
SEMB Pinzas para coger huesos	99		
SEMB Pinzas-Clamps bronquiales	123	Y	
Separador vascular	178	YANKAUER Tubo de aspiracion	89
Separadores	63-68		
Separadores autostaticas	79-80	Z	
Separadores costales	109,110,118		
Separadores para aorta	76,77		
Separadores para scapula	73		

Página

ZAUFAL-JANSEN Pinzas-gubias	101
ZENKER Pinzas para preparaciones y ligaduras	52
ZENKER Separadores	68

NUMMERNVERZEICHNIS · NUMMERICAL INDEX · INDEX DES NUMÉROS · INDICE NUMERIO

Kat.Nr. Cat.No. No. Réf. No. Ref.	Seite Page Page Página	Kat.Nr. Cat.No. No. Réf. No. Ref.	Seite Page Page Página	Kat.Nr. Cat.No. No. Réf. No. Ref.	Seite Page Page Página	Kat.Nr. Cat.No. No. Réf. No. Ref.	Seite Page Page Página
12.00091	13.00118	13.0401SC12	13.061114
12.00101	13.0011SC8	13.040412	13.0611SC14
12.00111	13.00128	13.0404SC12	13.061214
12.00121	13.0012SC8	13.040512	13.0612SC14
12.00131	13.00138	13.0405SC12	13.061314
12.00141	13.0013SC8	13.040612	13.0613SC14
12.00151	13.00148	13.0406SC12	13.066014
12.00161	13.0014SC8	13.040712	13.0660SC14
12.00171	13.0014SCZ8	13.0407SC12	13.066114
12.00182	13.00158	13.040812	13.0661SC14
12.00192	13.0015SC8	13.0408SC12	13.066214
12.00202	13.0015SCZ8	13.040912	13.0662SC14
12.00212	13.00228	13.0409SC12	13.066314
12.00222	13.00238	13.043212	13.0663SC14
12.00232	13.00328	13.0432SC12	13.066414
12.00242	13.00338	13.043312	13.0664SC14
12.00252	13.00438	13.0433SC12	13.066514
12.00342	13.0043SC8	13.043412	13.0665SC14
12.00362	13.00458	13.0434SC12	13.066614
12.00421	13.00518	13.043512	13.0666SC14
12.00442	13.00538	13.0435SC12	13.066714
12.00451	13.00558	13.043612	13.0667SC14
12.00462	13.00568	13.043712	13.070015
12.00602	13.00578	13.043812	13.070115
12.00616	13.00609	13.043912	13.075215
12.00626	13.0060SC9	13.056112	13.075315
12.0062S6	13.00619	13.056212	13.075715
12.00656	13.0061SC9	13.056312	13.076015
12.00676	13.00629	13.056513	13.076115
12.01013	13.00639	13.056713	13.076515
12.01023	13.00709	13.057513	13.0765SC15
12.01033	13.00719	13.057713	13.077016
12.01043	13.00769	13.059413	13.0770SC16
12.01053	13.00779	13.0594SC13	13.077116
12.01063	13.00789	13.059513	13.0771SC16
12.01073	13.00799	13.0595SC13	13.077216
12.01084	13.00809	13.059613	13.077316
12.01094	13.0080SC9	13.059713	13.078016
12.01134	13.00819	13.059813	13.078116
12.01144	13.0081SC9	13.0598SC13	13.0781SC16
12.01154	13.00829	13.059913	13.078316
12.01175	13.0082SC9	13.0599SC13	13.102017
12.01235	13.00839	13.060014	13.103017
12.01255	13.0083SC9	13.0600SC14	13.108117
12.01275	13.008910	13.060114	13.109018
12.01335	13.010210	13.0601SC14	13.109118
12.01446	13.010310	13.060214	13.109218
12.01496	13.011210	13.0602SC14	13.109318
12.01636	13.011310	13.060314	13.110018
12.01806	13.012210	13.0603SC14	13.110118
12.01826	13.012310	13.060414	13.110218
12.01846	13.013011	13.0604SC14	13.110318
12.01866	13.013111	13.060514	13.110418
12.01886	13.014011	13.0605SC14	13.110518
12.50007	13.0140SC11	13.060614	13.111018
12.50017	13.014111	13.0606SC14	13.111118
12.50107	13.0141SC11	13.060714	13.111218
12.50127	13.0143SC11	13.0607SC14	13.111318
12.50207	13.014611	13.060814	13.111418
12.51007	13.014711	13.0608SC14	13.113018
		13.040012	13.060914	13.1130SC18
13.00108	13.0400SC12	13.061014	13.113118
13.0010SC8	13.040112	13.0610SC14	13.1131SC18

Kat.Nr. Cat.No. No. Réf. No. Ref.	Seite Page Page Página	Kat.Nr. Cat.No. No. Réf. No. Ref.	Seite Page Page Página	Kat.Nr. Cat.No. No. Réf. No. Ref.	Seite Page Page Página	Kat.Nr. Cat.No. No. Réf. No. Ref.	Seite Page Page Página
13.1132	.18	13.5323	.23	14.0125	.25	14.0629	.29
13.1132SC	.18	13.5324	.23	14.0127	.25	14.0630	.29
13.1133	.19	13.5325	.23	14.0128	.25	14.0653	.29
13.1150	.19	13.5327	.23	14.0128T	.25	14.0790	.29
13.1151	.19	13.5328	.23	14.0129	.25	14.0792	.29
13.1152	.19	13.5329	.23	14.0130	.25	14.0800	.29
13.1160	.19	13.5330	.23	14.0142	.25	14.0801	.29
13.1161	.19	13.5331	.23	14.0143	.25	14.0810	.30
13.1162	.19	13.5333	.23	14.0144	.25	14.0820	.30
13.1165	.19	13.5334	.23	14.0300	.25	14.0821	.30
13.1166	.19	13.5335	.23	14.0301	.25	14.0825	.30
13.1170	.19	13.5337	.23	14.0310	.26	14.0830	.30
13.1180	.20	13.5338	.23	14.0311	.26	14.0850	.30
13.1182	.20	13.5339	.23	14.0320	.26	14.0851	.30
13.1190	.20	13.5360	.23	14.0321	.26	14.0852	.30
13.3010	.20	13.5361	.23	14.0325	.26	14.0853	.30
13.3014	.20	13.5364	.23	14.0328	.26	14.0854	.30
13.3015	.20	13.5365	.23	14.0330	.26	14.0855	.30
13.5000	.21	13.5370	.23	14.0350	.26	14.1000	.34
13.5001	.21	13.5371	.23	14.0350T	.26	14.1002	.34
13.5007	.21	13.5374	.23	14.0351	.26	14.1004	.34
13.5010	.21	13.5375	.23	14.0352	.26	14.1007T	.34
13.5011	.21	13.5380	.23	14.0352T	.26	14.1008T	.34
13.5020	.21	13.5381	.23	14.0353	.26	14.1009T	.34
13.5021	.21	13.5401	.24	14.0354	.26	14.1010	.34
13.5030	.21	13.5600	.24	14.0354T	.26	14.1010T	.34
13.5031	.21	13.5601	.24	14.0370	.27	14.1012	.34
13.5041	.21	13.5602	.24	14.0380	.27	14.1012T	.34
13.5200	.22	13.5610	.24	14.0382	.27	14.1014	.34
13.5201	.22	13.5611	.24	14.0384	.27	14.1014T	.34
13.5202	.22	13.5612	.24	14.0510	.28	14.1016	.34
13.5203	.22	13.5620	.24	14.0511	.28	14.1016T	.34
13.5204	.22	13.5621	.24	14.0513	.28	14.1017T	.34
13.5205	.22	13.5622	.24	14.0530	.28	14.1018T	.34
13.5210	.22	13.5630	.24	14.0532	.28	14.1019T	.34
13.5211	.22	13.5631	.24	14.0540	.28	14.1021	.34
13.5212	.22	13.5632	.24	14.0540T	.28	14.1021T	.34
13.5213	.22			14.0541	.28	14.1023	.34
13.5220	.22	14.0010	.25	14.0542	.28	14.1023T	.34
13.5221	.22	14.0011	.25	14.0543	.28	14.1025	.34
13.5240	.22	14.0013	.25	14.0545	.28	14.1025T	.34
13.5241	.22	14.0030	.25	14.0546	.28	14.1027	.34
13.5242	.22	14.0032	.25	14.0547	.28	14.1027T	.34
13.5243	.22	14.0040	.25	14.0548	.28	14.1030	.34
13.5250	.22	14.0040T	.25	14.0550	.28	14.1030T	.34
13.5251	.22	14.0042	.25	14.0570	.28	14.1032	.34
13.5291	.22	14.0042T	.25	14.0570T	.28	14.1032T	.34
13.5300	.23	14.0070	.25	14.0600	.29	14.1034	.34
13.5301	.23	14.0070T	.25	14.0601	.29	14.1034T	.34
13.5304	.23	14.0101	.25	14.0602	.29	14.1036	.34
13.5305	.23	14.0102	.25	14.0603	.29	14.1036T	.34
13.5308	.23	14.0103	.25	14.0605	.29	14.1040	.35
13.5309	.23	14.0104	.25	14.0607	.29	14.1040T	.35
13.5310	.23	14.0105	.25	14.0608	.29	14.1042	.35
13.5311	.23	14.0107	.25	14.0609	.29	14.1042T	.35
13.5313	.23	14.0108	.25	14.0620	.29	14.1044	.35
13.5314	.23	14.0109	.25	14.0621	.29	14.1044T	.35
13.5315	.23	14.0120	.25	14.0622	.29	14.1046	.35
13.5317	.23	14.0121	.25	14.0623	.29	14.1046T	.35
13.5318	.23	14.0122	.25	14.0624	.29	14.1050	.35
13.5319	.23	14.0123	.25	14.0625	.29	14.1050T	.35
13.5320	.23	14.0123T	.25	14.0627	.29	14.1052	.35
13.5321	.23	14.0124	.25	14.0628	.29	14.1052T	.35

Kat.Nr. Cat.No. No. Réf. No. Ref.	Seite Page Page Página	Kat.Nr. Cat.No. No. Réf. No. Ref.	Seite Page Page Página	Kat.Nr. Cat.No. No. Réf. No. Ref.	Seite Page Page Página	Kat.Nr. Cat.No. No. Réf. No. Ref.	Seite Page Page Página
14.1054	.35	14.3081	.41	15.0015	.45	15.0230	.48
14.1054T	.35	14.3100	.39	15.0020	.45	15.0231	.48
14.1060	.35	14.3102	.39	15.0021	.45	15.0236	.48
14.1060T	.35	14.3104	.39	15.0022	.45	15.0237	.48
14.1062	.35	14.3106	.39	15.0023	.45	15.0240	.48
14.1062T	.35	14.3108	.39	15.0024	.45	15.0241	.48
14.1064	.35	14.3110	.39	15.0025	.45	15.0250	.49
14.1064T	.35	14.3112	.39	15.0026	.45	15.0251	.49
14.2000	.36	14.3114	.39	15.0027	.45	15.0252	.49
14.2002	.36	14.3116	.39	15.0028	.45	15.0253	.49
14.2005	.36	14.3118	.39	15.0029	.45	15.0300	.49
14.2007	.36	14.3120	.39	15.0030	.45	15.0301	.49
14.2020	.36	14.3122	.39	15.0031	.45	15.0302	.49
14.2021	.36	14.3124	.39	15.0032	.45	15.0303	.49
14.2023	.36	14.3126	.39	15.0033	.45	15.0306	.49
14.2049	.36	14.3128	.39	15.0040	.45	15.0307	.49
14.2050	.36	14.3141	.40	15.0050	.46	15.0308	.49
14.2052	.36	14.3143	.40	15.0051	.46	15.0309	.49
14.2054	.36	14.3145	.40	15.0053	.46	15.0310	.49
14.2070	.36	14.3147	.40	15.0058	.46	15.0311	.49
14.2072	.36	14.3149	.40	15.0060	.46	15.0313	.50
14.2074	.36	14.3151	.40	15.0061	.46	15.0315	.50
14.2103	.36	14.3153	.40	15.0100	.46	15.0316	.50
14.2107	.36	14.3155	.40	15.0101	.46	15.0317	.50
14.2108	.36	14.3157	.40	15.0102	.46	15.0320	.50
14.2109	.36	14.3159	.40	15.0103	.46	15.0321	.50
14.2123	.36	14.3161	.40	15.0104	.46	15.0323	.50
14.2127	.36	14.3163	.40	15.0105	.46	15.0324	.50
14.2128	.36	14.3165	.40	15.0108	.46	15.0325	.50
14.2129	.36	14.3167	.40	15.0118	.46	15.0360	.50
14.2200	.37	14.3169	.40	15.0119	.46	15.0361	.50
14.2202	.37	14.3202	.41	15.0120	.47	15.0362	.50
14.2204	.37	14.3204	.41	15.0120T	.47	15.0363	.50
14.2210	.37	14.3206	.42	15.0121	.47	15.0364	.50
14.2212	.37	14.3208	.42	15.0121T	.47	15.0365	.50
14.2214	.37	14.3212	.41	15.0122	.47	15.0366	.50
14.2220	.37	14.3214	.41	15.0123	.47	15.0367	.50
14.2222	.37	14.3216	.42	15.0124	.47	15.0392	.50
14.2224	.37	14.3218	.42	15.0125	.47	15.0393	.50
14.2230	.37	14.3222	.41	15.0126	.47	15.0430	.51
14.2232	.37	14.3224	.41	15.0127	.47	15.0431	.51
14.2234	.37	14.3226	.42	15.0128	.47	15.0432	.51
14.2240	.37	14.3228	.42	15.0129	.47	15.0433	.51
14.2242	.37	14.3900	.43	15.0130	.47	15.0450	.51
14.2244	.37	14.3910	.43	15.0131	.47	15.0451	.51
14.2320	.37	14.3920	.43	15.0136	.47	15.0452	.51
14.2623	.37	14.3930	.43	15.0137	.47	15.0453	.51
14.2625	.37	14.3940	.43	15.0200	.47	15.0454	.51
14.2627	.37	14.3950	.43	15.0200T	.47	15.0455	.51
14.2628	.37			15.0201	.47	15.0458	.51
14.2629	.37	15.0001	.45	15.0201T	.47	15.0459	.51
14.2630	.37	15.0002	.45	15.0210	.48	15.0460	.51
14.2820	.37	15.0003	.45	15.0210T	.48	15.0461	.51
14.2890	.37	15.0004	.45	15.0211	.48	15.0462	.51
14.2900	.37	15.0005	.45	15.0211T	.48	15.0463	.51
14.3000	.38	15.0006	.45	15.0212	.48	15.0464	.51
14.3002	.38	15.0008	.45	15.0213	.48	15.0465	.51
14.3003	.38	15.0009	.45	15.0214	.48	15.0466	.51
14.3005	.38	15.0010	.45	15.0215	.48	15.0467	.51
14.3007	.38	15.0011	.45	15.0220	.48	15.0468	.51
14.3009	.38	15.0012	.45	15.0222	.48	15.0469	.51
14.3061	.41	15.0013	.45	15.0224	.48	15.0470	.51
14.3071	.41	15.0014	.45	15.0225	.48	15.0471	.51

Kat.Nr. Cat.No. No. Réf. No. Ref.	Seite Page Page Página	Kat.Nr. Cat.No. No. Réf. No. Ref.	Seite Page Page Página	Kat.Nr. Cat.No. No. Réf. No. Ref.	Seite Page Page Página	Kat.Nr. Cat.No. No. Réf. No. Ref.	Seite Page Page Página
15.0472	.51	15.0745	.56	17.0522	.64	17.1306	.72
15.0473	.51	15.0762	.56	17.0570	.64	17.1310	.72
15.0476	.51	15.0764	.56	17.0571	.64	17.1320	.73
15.0477	.51	15.0765	.56	17.0575	.64	17.1322	.73
15.0480	.51	15.0766	.56	17.0577	.64	17.1400	.74
15.0481	.51	15.0770	.56	17.0578	.64	17.1410	.75
15.0492	.51	15.0771	.56	17.0579	.64	17.5010	.79
15.0494	.51	15.0772	.56	17.0585	.65	17.5011	.79
15.0495	.52	15.0773	.56	17.0670	.65	17.5012	.79
15.0496	.52	15.0774	.56	17.0680	.65	17.5013	.79
15.0497	.52	15.0775	.56	17.0681	.65	17.5150	.79
15.0500	.52	15.0776	.56	17.0682	.65	17.5290	.79
15.0501	.52	15.0780	.57	17.0683	.65	17.5302	.79
15.0521	.52	15.0782	.57	17.0684	.65	17.5303	.79
15.0523	.52	15.0786	.57	17.0690	.66	17.5304	.79
15.0531	.55	15.0801	.57	17.0691	.66	17.5305	.79
15.0532	.55	15.0802	.57	17.0692	.66	17.5306	.79
15.0533	.55	15.0803	.57	17.0693	.66	17.5307	.79
15.0534	.55	15.0807	.57	17.0694	.66	17.5308	.79
15.0535	.55	15.0811	.57	17.0695	.66	17.5309	.79
15.0536	.55	15.0813	.57	17.0900	.66	17.5600	.80
15.0537	.55	15.0817	.57	17.1070	.66	17.5601	.80
15.0538	.55	15.0831	.57	17.1071	.66	17.5602	.80
15.0539	.55	15.0833	.57	17.1072	.66	17.5603	.80
15.0600	.52	15.0835	.57	17.1073	.66	17.5604	.80
15.0601	.52	15.1580	.58	17.1074	.66	17.5605	.80
15.0602	.52	15.1582	.58	17.1075	.67	17.5606	.80
15.0603	.52	15.1721	.54	17.1076	.67	17.5607	.80
15.0604	.52	15.1722	.54	17.1077	.67		
15.0605	.52	15.1723	.54	17.1078	.67	18.0040	.81
15.0606	.52	15.1724	.54	17.1080	.67	18.0042	.81
15.0607	.52	15.1725	.54	17.1081	.67	18.0050	.81
15.0620	.53	15.1726	.54	17.1082	.67	18.0069	.81
15.0621	.53	15.1727	.54	17.1083	.68	18.0070	.81
15.0622	.53	15.2230	.58	17.1084	.68	18.0072	.81
15.0623	.53	15.2232	.58	17.1085	.68	18.0074	.81
15.0624	.53	15.2234	.58	17.1086	.68	18.0076	.81
15.0625	.53	15.2360	.58	17.1087	.68	18.0079	.81
15.0626	.53	15.2361	.58	17.1088	.68	18.0080	.81
15.0627	.53	15.2362	.58	17.1196	.68	18.0082	.81
15.0628	.53	15.2363	.58	17.1197	.68	18.0084	.81
15.0629	.53	15.2365	.58	17.1198	.68	18.0086	.81
15.0630	.53	15.2366	.58	17.1199	.68	18.0088	.81
15.0631	.53	15.2367	.58	17.1200	.68	18.0090	.81
15.0632	.53	15.2368	.58	17.1232	.69	18.0091	.81
15.0633	.53			17.1233	.69	18.0100	.82
15.0701	.54	17.0040	.63	17.1234	.69	18.0102	.82
15.0703	.54	17.0041	.63	17.1240	.69	18.0104	.82
15.0720	.54	17.0050	.63	17.1250	.69	18.0106	.82
15.0721	.54	17.0052	.63	17.1251	.69	18.0108	.82
15.0722	.54	17.0460	.63	17.1255	.69	18.0110	.82
15.0723	.54	17.0461	.63	17.1256	.69	18.0113	.82
15.0724	.54	17.0462	.63	17.1257	.69	18.0130	.82
15.0725	.54	17.0463	.63	17.1274C	.70	18.0132	.82
15.0726	.54	17.0464	.63	17.1276C	.70	18.0134	.82
15.0727	.54	17.0500	.63	17.1277C	.70	18.0136	.82
15.0729	.54	17.0501	.63	17.1278C	.70	18.0138	.82
15.0731	.56	17.0502	.63	17.1279C	.70	18.0140	.82
15.0732	.56	17.0510	.63	17.1290	.71	18.0150	.82
15.0733	.56	17.0512	.63	17.1291	.71	18.0152	.82
15.0734	.56	17.0515	.64	17.1292	.71	18.0160	.83
15.0741	.56	17.0516	.64	17.1302	.72	18.0162	.83
15.0743	.56	17.0520	.64	17.1304	.72	18.0164	.83

Kat.Nr. Cat.No. No. Réf. No. Ref.	Seite Page Page Página	Kat.Nr. Cat.No. No. Réf. No. Ref.	Seite Page Page Página	Kat.Nr. Cat.No. No. Réf. No. Ref.	Seite Page Page Página	Kat.Nr. Cat.No. No. Réf. No. Ref.	Seite Page Page Página
18.0166	.83	19.0700	.89	23.0560	.95	28.0330	.35
18.0170	.83	19.0710	.89	23.0562	.95	28.0330S	.35
18.0180	.83	19.0718	.89	23.0565	.96	28.0332	.35
18.0190	.84	19.0719	.89	23.0570	.96	28.0332S	.35
18.0192	.84	19.0720	.89	23.0575	.96	28.0334	.35
18.0194	.84	19.0721	.89	23.0580	.96	28.0334S	.35
18.0202	.84	19.0727	.89	23.0581	.96	28.0600	.179
18.0204	.84	19.0746	.89	23.0582	.96	28.0602	.179
18.0210	.84	19.0750	.90	23.0583	.96	28.0604	.179
18.0212	.84	19.0751	.90	23.0590	.97	28.0606	.179
18.0214	.84	19.0752	.90	23.0592	.97	28.0608	.179
18.0242	.84	19.0753	.90	23.0593	.97	28.0610	.179
18.0244	.84	19.0754	.90	23.0594	.97	28.0612	.179
18.0246	.84	19.0760	.91	23.0601	.97	28.0614	.179
18.0250	.85	19.0761	.91	23.0602	.97	28.0616	.179
18.0252	.85	19.0762	.91	23.0603	.97	28.0618	.179
18.0254	.85	19.0763	.91	23.0604	.97	28.0622	.179
18.0256	.85	19.0764	.91	23.0605	.97	28.2600	.180
18.0260	.85	19.0765	.91	23.0606	.97	28.2601	.180
18.0262	.85	19.0770	.91	23.0607	.97	28.2602	.180
18.0264	.85	19.0771	.91	23.0620	.98	28.2603	.180
18.0266	.85	19.0772	.91	23.0621	.98	28.2605	.180
18.0270	.85	19.0773	.91	23.2210	.99	28.2608	.180
18.0272	.85	19.0774	.91	23.2211	.99	28.2609	.180
18.0274	.85	19.0775	.91	23.2220	.99	28.2620	.181
18.0280	.85	19.2000	.92	23.2232	.99	28.2622	.181
18.0322	.86	19.2001	.92	23.2234	.99	28.2623	.181
18.0330	.86	19.2002	.92	23.2235	.99	28.2624	.181
18.0331	.86	19.2003	.92	23.2240	.99	28.2625	.181
18.0332	.86	19.2006	.92	23.2302	.100	28.2628	.181
18.0334	.86	19.2009	.92	23.2304	.100	28.2629	.181
18.0336	.86	19.2012	.92	23.2305	.100	28.2640	.181
18.0530	.86	19.2015	.92	23.2306	.100	28.2641	.181
18.0532	.86	19.2018	.92	23.2307	.100	28.2656	.182
18.0534	.86	19.2019	.92	23.2831	.101	28.2657	.182
18.0536	.86			23.2833	.101	28.2659	.182
18.0538	.86	23.0036	.93	23.2835	.101	28.3501	.183
18.0540	.86	23.0050	.93	23.2837	.101	28.3504	.183
18.0550	.86	23.0052	.93	23.2840	.101	28.3505	.183
18.0552	.86	23.0060	.93	23.2841	.101	28.3506	.183
18.0554	.86	23.0080	.93	23.2849	.101	28.3507	.183
18.0556	.86	23.0081	.93	23.2851	.102	28.3509	.183
18.0558	.86	23.0082	.93	23.2856	.102	28.3520	.184
18.0560	.86	23.0090	.94	23.2857	.102	28.3521	.184
18.0600	.87	23.0091	.94	23.2858	.102	28.3522	.184
18.0602	.87	23.0092	.94	23.2880	.102	28.3523	.184
18.0604	.87	23.0093	.94	23.2881	.102		
18.0606	.87	23.0094	.94	23.2890	.102	40.0008	.106
18.0610	.87	23.0095	.94	23.2910	.103	40.0010	.106
18.0612	.87	23.0519	.94	23.2912	.103	40.0020	.106
18.0800	.87	23.0520	.94	23.3122	.104	40.0030	.106
18.0801	.87	23.0521	.94	23.3123	.104	40.0040	.107
18.0802	.87	23.0522	.94	23.3150	.104	40.0046	.107
18.0803	.87	23.0523	.94	23.3151	.104	40.0047	.107
18.0804	.87	23.0530	.94	23.3161	.105	40.0060	.107
18.0805	.87	23.0531	.95	23.3162	.105	40.0062	.107
18.0810	.87	23.0540	.95			40.0080	.107
18.0811	.87	23.0542	.95	28.0320	.35	40.0090	.107
18.0812	.87	23.0544	.95	28.0320S	.35	40.0095	.108
18.0813	.87	23.0546	.95	28.0322	.35	40.0100	.108
18.0814	.87	23.0548	.95	28.0322S	.35	40.0110	.108
18.0815	.87	23.0550	.95	28.0324	.35	40.0120	.108
18.0840	.87	23.0552	.95	28.0324S	.35	40.0121	.108

Kat.Nr. Cat.No. No. Réf. No. Ref.	Seite Page Page Página	Kat.Nr. Cat.No. No. Réf. No. Ref.	Seite Page Page Página	Kat.Nr. Cat.No. No. Réf. No. Ref.	Seite Page Page Página	Kat.Nr. Cat.No. No. Réf. No. Ref.	Seite Page Page Página
40.0130	.108	40.0630	.120	40.1350	.132	40.2140	.137
40.0391	.76	40.0650	.121	40.1351	.132	40.2141	.137
40.0392	.76	40.0660	.121	40.1352	.132	40.2142	.137
40.0393	.76	40.0701	.122	40.1353	.132	40.2145	.137
40.0394	.76	40.0702	.122	40.1354	.132	40.2146	.137
40.0395	.76	40.0720	.122	40.1355	.132	40.2147	.137
40.0396	.76	40.0730	.122	40.1357	.132	40.2150	.138
40.0400	.77	40.0740	.122	40.1660	.132	40.2151	.138
40.0402	.77	40.0742	.122	40.1662	.132	40.2152	.138
40.0410	.77	40.0750	.123	40.1664	.132	40.2153	.138
40.0411	.77	40.0751	.123	40.1666	.132	40.2154	.138
40.0412	.77	40.0761	.123	40.1668	.132	40.2155	.138
40.0413	.77	40.0763	.123	40.1690	.133	40.2156	.138
40.0430	.109	40.0901	.124	40.1691	.133	40.2157	.138
40.0431	.109	40.0905	.124	40.1698	.133	40.2158	.138
40.0432	.109	40.0910	.124	40.1729	.133	40.2159	.138
40.0433	.109	40.0911	.124	40.1750	.134	40.2160	.138
40.0434	.109	40.0912	.124	40.1751	.134	40.2161	.138
40.0435	.110	40.0913	.124	40.1752	.134	40.2588	.139
40.0436	.110	40.0914	.124	40.1753	.134	40.2589	.139
40.0437	.110	40.0915	.124	40.1754	.134	40.2590	.139
40.0438	.110	40.0920	.125	40.1760	.134	40.2591	.139
40.0439	.110	40.0925	.125	40.1761	.134	40.2592	.139
40.0450	.111	40.0930	.125	40.1762	.134	40.2800	.173
40.0451	.111	40.0935	.125	40.1763	.134	40.2801	.173
40.0452	.111	40.0950	.126	40.1764	.134	40.2802	.173
40.0454	.111	40.0955	.126	40.1765	.135	40.2803	.173
40.0456	.111	40.0960	.126	40.1769	.135	40.2804	.173
40.0461	.112	40.0965	.126	40.1770	.135	40.2805	.173
40.0462	.112	40.0976	.126	40.1773	.135	40.2806	.173
40.0500	.112	40.1000	.127	40.1775	.135	40.2807	.173
40.0501	.112	40.1005	.127	40.2001	.136	40.2808	.173
40.0506	.113	40.1025	.127	40.2002	.136	40.2810	.173
40.0510	.113	40.1030	.127	40.2003	.136	40.2820	.173
40.0511	.113	40.1035	.127	40.2004	.136	40.2821	.173
40.0520	.114	40.1036	.127	40.2005	.136	40.2822	.173
40.0523	.114	40.1050	.128	40.2006	.136	40.2823	.173
40.0525	.114	40.1055	.128	40.2007	.136	40.2824	.173
40.0531	.115	40.1075	.128	40.2008	.136	40.2825	.173
40.0533	.115	40.1080	.128	40.2009	.136	40.2826	.173
40.0535	.115	40.1085	.128	40.2021	.136	40.2827	.173
40.0540	.116	40.1090	.128	40.2022	.136	40.2828	.173
40.0550	.116	40.1091	.128	40.2023	.136	40.2830	.173
40.0551	.116	40.1092	.128	40.2024	.136	40.3000	.173
40.0552	.116	40.1150	.129	40.2025	.136	40.3001	.173
40.0553	.116	40.1151	.129	40.2026	.136	40.3002	.173
40.0554	.116	40.1152	.129	40.2027	.136	40.3003	.173
40.0555	.116	40.1153	.129	40.2028	.136	40.3004	.173
40.0561	.117	40.1154	.129	40.2029	.136	40.3005	.173
40.0563	.117	40.1155	.129	40.2041	.136	40.3006	.173
40.0565	.117	40.1157	.129	40.2042	.136	40.3007	.173
40.0567	.117	40.1158	.129	40.2043	.136	40.3008	.173
40.0568	.117	40.1300	.130	40.2044	.136	40.3009	.173
40.0569	.117	40.1301	.130	40.2045	.136	40.3010	.173
40.0570	.118	40.1302	.130	40.2046	.136	40.3011	.173
40.0581	.118	40.1303	.130	40.2047	.136	40.3012	.173
40.0583	.118	40.1304	.130	40.2048	.136	40.3030	.173
40.0585	.118	40.1305	.130	40.2049	.136	40.3031	.173
40.0590	.119	40.1333	.131	40.2130	.137	40.3032	.173
40.0600	.120	40.1334	.131	40.2133	.137	40.3033	.173
40.0610	.120	40.1335	.131	40.2135	.137	40.3034	.173
40.0612	.120	40.1340	.131	40.2137	.137	40.3035	.173
40.0620	.120	40.1342	.131	40.2139	.137	40.3036	.173

Kat.Nr. Cat.No. No. Réf. No. Ref.	Seite Page Page Página	Kat.Nr. Cat.No. No. Réf. No. Ref.	Seite Page Page Página	Kat.Nr. Cat.No. No. Réf. No. Ref.	Seite Page Page Página	Kat.Nr. Cat.No. No. Réf. No. Ref.	Seite Page Page Página
40.3037	173	40.4212	176	41.0050A	144	41.0166	148
40.3038	173	40.4214	176	41.0050V	144	41.0167	148
40.3039	173	40.4219	176	41.0051A	144	41.0200	149
40.3040	173	40.9071	185	41.0051V	144	41.0203	149
40.3041	173	40.9072	185	41.0052A	144	41.0210	149
40.3042	173	40.9286	185	41.0052V	144	41.0213	149
40.3060	174	40.9287	185	41.0053A	144	41.0235	150
40.3061	174	40.9325	185	41.0053V	144	41.0240	150
40.3062	174	40.9326	185	41.0054A	144	41.0245	150
40.3063	174	40.9396	185	41.0054V	144	41.0250	150
40.3064	174	40.9397	185	41.0055A	144	41.0260	151
40.3066	174	40.9398	185	41.0055V	144	41.0262	151
40.3068	174	40.9399	185	41.0056A	144	41.0265	151
40.3069	174	40.9400	185	41.0056V	144	41.0267	151
40.3070	174	40.9401	185	41.0057A	144	41.0270	151
40.3071	174	40.9402	185	41.0057V	144	41.0290	152
40.3072	174	40.9403	185	41.0061A	144	41.0291	152
40.3075	174	40.9404	185	41.0061V	144	41.0292	152
40.3076	174	40.9405	185	41.0063A	144	41.0317	152
40.3103	173	40.9406	185	41.0063V	144	41.0319	152
40.3104	173	40.9407	185	41.0065A	144	41.0340	153
40.3105	173	40.9408	185	41.0065V	144	41.0341	153
40.3106	173	40.9409	185	41.0067A	144	41.0342	153
40.3150	175	40.9410	185	41.0067V	144	41.0343	153
40.3152	175	40.9411	185	41.0080	143	41.0345	153
40.3160	175	40.9412	185	41.0081	143	41.0346	153
40.3162	175	40.9413	185	41.0082	143	41.0347	153
40.3200	177	40.9414	185	41.0083	143	41.0600	154
40.3201	177	40.9415	185	41.0084	143	41.0602	154
40.3202	177	40.9416	185	41.0085	143	41.0605	154
40.3203	177	40.9417	185	41.0089	143	41.0607	154
40.3223	177	40.9418	185	41.0090	145	41.0610	155
40.3224	177	40.9419	185	41.0091	145	41.0620	155
40.3225	177			41.0092	145	41.0630	156
40.3226	177	41.0000	140	41.0093	145	41.0631	156
40.3233	177	41.0001	140	41.0094	145	41.0632	156
40.3234	177	41.0005	140	41.0095	145	41.0635	156
40.3235	177	41.0006	140	41.0099	145	41.0640	156
40.3236	177	41.0010	140	41.0100	145	41.0642	157
40.3260	177	41.0011	140	41.0101	145	41.0643	157
40.3262	177	41.0015	140	41.0110	145	41.0645	158
40.3264	177	41.0016	140	41.0111	145	41.0650	158
40.3266	177	41.0019	140	41.0115	145	41.0651	159
40.3268	177	41.0020	141	41.0116	145	41.0652	159
40.3269	177	41.0021	141	41.0120	145	41.0653	159
40.3300	178	41.0022	141	41.0121	145	41.0654	159
40.3312	178	41.0023	141	41.0130	146	41.0655	159
40.3400	178	41.0024	141	41.0132	146	41.0656	159
40.3401	175	41.0025	141	41.0134	146	41.0657	160
40.3403	175	41.0028	142	41.0136	146	41.0658	160
40.3405	175	41.0030	142	41.0138	146	41.0659	160
40.3410	175	41.0031	142	41.0140	147	41.0660	160
40.3412	175	41.0032	142	41.0144	147	41.0662	160
40.3414	175	41.0033	142	41.0146	147	41.0664	160
40.3416	175	41.0034	142	41.0147	147	41.0666	160
40.4100	176	41.0035	142	41.0150	148	41.0668	160
40.4202	176	41.0037	142	41.0151	148	41.0670	160
40.4203	176	41.0040	143	41.0160	148	41.0680	161
40.4204	176	41.0041	143	41.0161	148	41.0682	161
40.4206	176	41.0042	143	41.0162	148	41.0684	161
40.4207	176	41.0043	143	41.0163	148	41.0686	161
40.4208	176	41.0044	143	41.0164	148	41.0690	161
40.4210	176	41.0045	143	41.0165	148	41.0692	161

Kat.Nr. Cat.No. No. Réf. No. Ref.	Seite Page Page Página	Kat.Nr. Cat.No. No. Réf. No. Ref.	Seite Page Page Página	Kat.Nr. Cat.No. No. Réf. No. Ref.	Seite Page Page Página	Kat.Nr. Cat.No. No. Réf. No. Ref.	Seite Page Page Página
41.0694	.161	48.0010	.59	48.0098	.62	48.0092	.62
41.0696	.161	48.0011	.59	48.0098AT	.62	48.0094	.62
41.0700	.162	48.0014	.59	48.0099	.62	48.0094AT	.62
41.0701	.162	48.0016	.59	48.0010	.59	48.0098	.62
41.0825	.163	48.0020	.59	48.0011	.59	48.0098AT	.62
41.0826	.163	48.0024	.59	48.0014	.59	48.0099	.62
41.0827	.163	48.0004	.59	48.0016	.59		
41.0828	.163	48.0006	.59	48.0020	.59		
41.0831	.164	48.0028	.59	48.0024	.59		
41.0832	.164	48.0030	.59	48.0004	.59		
41.0833	.164	48.0032	.60	48.0006	.59		
41.0834	.164	48.0034	.60	48.0028	.59		
41.0886	.165	48.0036	.60	48.0030	.59		
41.0887	.165	48.0038	.60	48.0032	.60		
41.0910	.165	48.0040	.60	48.0034	.60		
41.0911	.165	48.0045	.60	48.0036	.60		
41.0912	.165	48.0062	.60	48.0038	.60		
41.0913	.165	48.0064	.60	48.0040	.60		
41.0915	.165	48.0066	.60	48.0045	.60		
41.0916	.165	48.0068	.60	48.0062	.60		
41.0917	.165	48.0072	.61	48.0064	.60		
41.0918	.165	48.0076	.61	48.0066	.60		
41.0930	.166	48.0082	.61	48.0068	.60		
41.0932	.166	48.0086	.61	48.0072	.61		
41.0940	.166	48.0088	.61	48.0076	.61		
41.0942	.166	48.0089	.62	48.0082	.61		
41.0945	.166	48.0090	.62	48.0086	.61		
41.0947	.166	48.0092	.62	48.0088	.61		
41.1160	.167	48.0094	.62	48.0089	.62		
41.1161	.167	48.0094AT	.62	48.0090	.62		
41.1162	.167	48.0098	.62	48.0092	.62		
41.1163	.167	48.0098AT	.62	48.0094	.62		
41.1164	.167	48.0099	.62	48.0094AT	.62		
41.1165	.167	48.0010	.59	48.0098	.62		
41.1166	.167	48.0011	.59	48.0098AT	.62		
41.1167	.167	48.0014	.59	48.0099	.62		
41.1360	.168	48.0016	.59	48.0010	.59		
41.1363	.168	48.0020	.59	48.0011	.59		
41.1370	.168	48.0024	.59	48.0014	.59		
41.1372	.168	48.0004	.59	48.0016	.59		
41.1522	.169	48.0006	.59	48.0020	.59		
41.1523	.169	48.0028	.59	48.0024	.59		
41.1524	.169	48.0030	.59	48.0004	.59		
41.1529	.169	48.0032	.60	48.0006	.59		
41.1530	.169	48.0034	.60	48.0028	.59		
41.1535	.169	48.0036	.60	48.0030	.59		
41.1537	.169	48.0038	.60	48.0032	.60		
41.1539	.169	48.0040	.60	48.0034	.60		
41.1550	.170	48.0045	.60	48.0036	.60		
41.1555	.170	48.0062	.60	48.0038	.60		
41.1565	.170	48.0064	.60	48.0040	.60		
41.1566	.170	48.0066	.60	48.0045	.60		
41.1567	.170	48.0068	.60	48.0062	.60		
41.1571	.170	48.0072	.61	48.0064	.60		
41.1580	.171	48.0076	.61	48.0066	.60		
41.1581	.171	48.0082	.61	48.0068	.60		
41.1585	.171	48.0086	.61	48.0072	.61		
41.1586	.171	48.0088	.61	48.0076	.61		
41.1590	.171	48.0089	.62	48.0082	.61		
41.1591	.171	48.0090	.62	48.0086	.61		
41.1593	.172	48.0092	.62	48.0088	.61		
41.1657	.172	48.0094	.62	48.0089	.62		
41.1658	.172	48.0094AT	.62	48.0090	.62		

PRO-MED
INSTRUMENTE GmbH

Gänsäcker 9
D-78532 Tuttlingen · Germany
Tel. +49(0) 74 62/20 42 40
Fax +49(0) 74 62/20 42 49 0
E-Mail: pro-med-tut@t-online.de
www.pro-med-tut.de

